



Da oltre 10 anni, Lacus, azienda Italiana, progetta e distribuisce chiusure doccia, uniche nel design, accessibili ad una vasta clientela e destinate a rappresentare, in Italia e nel mondo, l'arredo bagno d'alta scuola Italiana, anticipando ed interpretando i cambiamenti e le abitudini della società contemporanea.

*For more than 10 years, the Italian company **Lacus** has been designing and distributing unique pieces of shower enclosures.*

Sleek by design and widely affordable, Lacus shower enclosures are destined to represent, in Italy as worldwide, the recognizable Italian style and quality, anticipating the changes and evolving habits of the society.

*Seit mehr als 10 Jahren gestaltet und verteilt die Italienischen Firma **Lacus** Duschkabinen, die einzigartig im Design und wirtschaftlich für alle sind.*

Lacus Duschkabinen sind dazu bestimmt, die Badezimmersausstattung der Italienische High School in Italien und in der Welt zu repräsentieren. Lacus Duschkabinen antizipieren und interpretieren die Veränderungen und Gewohnheiten der modernen Gesellschaft.

*Depuis plus d'une décennie, **LACUS**, Société Italienne, réalise et distribue des cabines de douche, d'une conception unique, accessibles à l'ensemble du marché.*

Destinées à représenter, en Italie et dans le monde, la salle de bain haute école Italienne, anticipant et interprétant les changements et les habitudes de la société moderne.

ITALIAN DESIGN



I SERVIZI

LACUS SERVICES
WAS BEI LACUS ZUR FINDEN IST
LACUS SERVICES

Materiale sempre disponibile.

*Goods always available.
Material immer zur Verfügung.
Materiel toujours disponible.*



Attiva sul mercato nazionale ed estero dal 2008.

*Active on the domestic and foreign market since 2008.
Tätig auf Innen- und Aussenmarkt seit 2008.
Présente sur le marché national et étranger depuis 2008.*



IL PRODOTTO

THE PRODUCT - DAS PRODUKT - LE PRODUIT

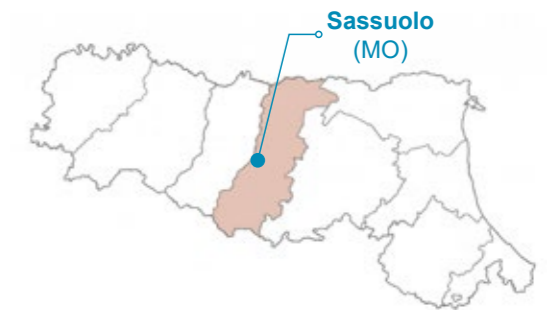

WWW.LACUS.IT

Il portale online dedicato agli addetti ai lavori consente di consultare e ordinare l'ampia gamma di prodotti.

The online portal for insiders allows you to consult and order the wide range of products.

Die Web-Seite für die Zuständigen die Einsicht der Lagerbeständen und die Bestellung davon erlaubt.

Le portail online sur Internet dédié aux professionnels du secteur permet de consulter et de commander une vaste gamme de produits.



WWW.LACUS.IT/FACEBOOK



WWW.LACUS.IT/LINKEDIN



WWW.LACUS.IT/YOUTUBE

36 CABINE AD APERTURA A BATTENTE 8 MM.

PIVOT DOOR CABINS 8 MM. / DUSCHKABINEN MIT DREHTÜR 8 MM. / CABINE DE DOUCHE OUVERTURE PIVOTANTE 8 MM.

| | | | |
|---|--|--|--|
|  | 38 40 | GIANNUTRI BLACK GIANNUTRI | ● LKBAG BLACK ● LKBAG |
|  | 42 44 46 48 | ELBA ELBA ELBA BLACK ELBA BLACK | ● LKBAN ● LKBA ● LKBAN BLACK ● LKBA BLACK |
|  | 54 58 | S.PIETRO GOLD S.PIETRO | ● LAB GOLD ● LAB |
|  | 64 | LAMPEDUSA | ● LRB EVO |
|  | 70 | CAPRAIA | ● LRBA |

74 CABINE AD APERTURA A BATTENTE 6 MM.

PIVOT DOOR CABINS 6 MM. / DUSCHKABINEN MIT DREHTÜR 6 MM. / CABINE DE DOUCHE OUVERTURE PIVOTANTE 6 MM.

| | | | |
|---|-------------------------------------|--|---|
|  | 76 | VENEZIA | ● LAP  |
|  | 78 82 | ALBARELLA ALBARELLA SALOON | ● LAPN  ● LAP |
|  | 86 88 | TREMITI TREMITI | ● LPBT ● LPBT |
|  | 94 96 98 | GRADO GRADO BLACK GRADO WHITE | ● LPBMG ● LPBMG BLACK ○ LPBMG WHITE |
|  | 100 | MURANO | ● LPBM |
|  | 106 | MURANO BLACK | ● LPBM BLACK |
|  | 112 | MURANO WHITE | ○ LPBM WHITE |

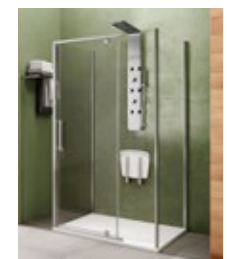

120

PIANOSA EVO

● LFD3



128
130

**MONTECRISTO
MONTECRISTO**

● LPBFN EVO
● LPBF EVO

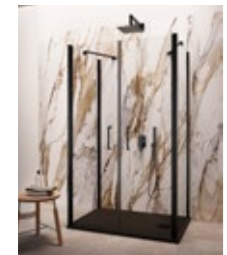

132
138
144
150

**GIGLIO EVO 2
GIGLIO EVO 2 B/T
GIGLIO EVO 2 BLACK
GIGLIO EVO 2 FOX**

● LPB3
● LPB3 BLACK / TRASP.
● LPB3 BLACK
● LPB3 FOX



156
162
168
174
180

**GIGLIO EVO 1
GIGLIO EVO 1 B/T
GIGLIO EVO 1 BLACK
GIGLIO EVO 1 FOX
GIGLIO CORNER**

● LPB3
● LPB3 BLACK / TRASP.
● LPB3 BLACK
● LPB3 FOX
● LPB EVO2 

184 CABINE AD APERTURA SCORREVOLE 8 MM.
SLIDING DOOR CABINS 8 MM. / DUSCHKABINEN MIT SCHIEBETÜREN 8 MM. / CABINE DE DOUCHE OUVERTURE COULISSANTE 8 MM.



186
190

**CAPRI MIRROR
CAPRI**

● LCBAM
● LCBA



196

ISCHIA EVO

● LSA-EVO



204

LA MADDALENA

● LSRAX



210

CAPRERA

● LSRA



216
220

**PANTELLERIA SQUARE
PANTELLERIA ROUND**

● LDFAS
● LDFAR

226 CABINE AD APERTURA SCORREVOLE 6 MM.
SLIDING DOOR CABINS 6 MM. / DUSCHKABINEN MIT SCHIEBETÜREN 6 MM. / CABINE DE DOUCHE OUVERTURE COULISSANTE 6 MM.

| | | | | |
|---|------------|---------------------------|----|----------------------|
|  | 228 | TORCELLO GOLD ROSE | ● | LPST GOLD ROSE |
| | 234 | | ● | LPST |
| | 240 | | ● | LPST BLACK |
| | 246 | | ○ | LPST WHITE |
|  | 256 | ASINARA | ● | LSA6 |
|  | 258 | PIANA | ● | LSA6N |
|  | 266 | EOLIE | ● | LPS EVO 2 |
|  | 276 | VULCANO EVO BLACK | ● | LASP3 BT QI |
| | 278 | | ● | LASP3 QI |
| | 280 | | ● | LASP3 M QI |
| | 282 | | ● | LASP3 F QI |
|  | 284 | VULCANO EVO | ● | LSSP3 QI |
| | 286 | | ● | LSSP3 M QI |
| | 288 | | ● | LSSP3 F QI |
|  | 290 | LIPARI EVO BLACK | ● | LASP3N BT QI |
| | 296 | | ● | LASP3N QI |
| | 302 | | ● | LASP3N M QI |
| | 308 | | ● | LASP3N F QI |
| | 338 | VULCANO PARETI | ●● | LPF3 QI /MATT/FOX/BT |

| | | | | |
|---|------------|----------------------|---|---------------------|
|  | 314 | STROMBOLI EVO | ● | LPS3 QI 4 DOORS |
| | 320 | | ● | LPS3 M QI 4 DOORS |
|  | 326 | PONZA EVO | ● | LL3 |
| | 332 | | ● | LL3 MATT |
|  | 344 | PANAREA EVO | ● | LA6 EVO |
| | 346 | | ● | LA6 EVO MATT |
| | 348 | | ● | LA6 EVO FOX |
|  | 350 | PANAREA EVO | ● | LS6 EVO |
| | 352 | | ● | LS6 EVO MATT |
| | 354 | | ● | LS6 EVO FOX |
|  | 356 | ORTIGIA | ● | LA6N EVO |
| | 362 | | ● | LA6N EVO MATT |
| | 368 | | ● | LA6N EVO FOX |
|  | 374 | FORMICA | ● | LL6 |
|  | 380 | PANAREA EVO | ● | LPF6 EVO |
| | 382 | | ● | LPF6 EVO MATT / FOX |

386 OPEN SPACE 8 MM.

PANNELS 8 MM. / WALK-IN 8 MM. / PAROIS 8 MM.



388
390

CAPRI WALL
CAPRI WALL MIRROR

● LCWI
● LCWIM



394
396
398

FILICUDI
FILICUDI INOX
FILICUDI BLACK

● LOSA E
● LOSA E INOX
● LOSA E BLACK

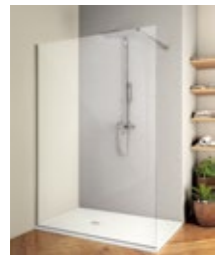

400
402
404
406
408

FILICUDI WALL
FILICUDI WALL INOX
FILICUDI WALL BT
FILICUDI WALL BLACK
FILICUDI WALL WHITE

● LOSA EW
● LOSA EW INOX
● LOSA EW BLACK / TRASP
● LOSA EW BLACK
○ LOSA EW WHITE



410
410

FILICUDI CLOSED
FILICUDI CLOSED BT

● LOSA EC
● LOSA EC BLACK / TRASP

414 OPEN SPACE 6 MM.

PANNELS 6 MM. / WALK-IN 6 MM. / PAROIS 6 MM.



416
418

TREMITI WALL
TREMITI WALL MATT

● LTWI
● LTWI M



422

ALICUDI WALL 6 MM

● LWI



426

SALINA

● LOSA P



430

LEVANZO

● LSVS



432

MARETTIMO EVO

● LSV E











434

FAVIGNANA EVO

● LSV EVO

438 PIATTI DOCCIA

SHOWER TRAYS / DUSCHTASSEN / RECEVEURS DE DOUCHE

| | | | |
|---|------------|-------------------|-----------------------|
|  | 440 | MARFIL | ○ LPDR3 MARFIL |
|  | 446 | SLATE EVO | ○ ● ● LPDR3 SLATE EVO |
|  | 454 | BRECCIA | ○ ● LPDR3 BRECCIA |
|  | 462 | LIMESTONE | ○ ● LPDR3 LIMESTONE |
|  | 470 | PETRA | ○ LPDR3 PETRA |
|  | 476 | WHITE SILK | ○ LPDR4 WHITE SILK |
|  | 478 | BLACK SILK | ● LPDR4 BLACK SILK |
|  | 484 | STONELITE | ○ LPDR3 STONELITE |

| | | | |
|---|------------|---|-------------------------|
|  | 490 | SLIM | ○ LPDQ4 / LPDR4 / LPDS4 |
| | 500 | DA VASCA IN DOCCIA SLIM FROM BATHTUB TO SHOWER SLIM | LVD |

502 COLONNE DOCCIA

SHOWER COLUMNS / DUSCHPANELE UND DUSCHSÄULE / COLONNES DE DOUCHE

| | | | |
|---|------------|------------------|--------------------|
|  | 506 | USTICA | ● LCDA 144C |
|  | 508 | BUDELLI | ● LCDC 166S |
|  | 510 | RAZZOLI | ○ LCD 140W |
|  | 512 | COLOMBAIA | ● LCD 130SG |
|  | 513 | PALOMBA | ● LCD 140SC |
|  | 514 | SPARGI | ● ● LCD 160 ○ ● |



516

MOLARA

● LCD 130B



518
519

**GORGONA
GORGONA CROMO**

○ LCD 120W
● LCD 120C



520
522
523

**SAN NICOLA / SAN DOMINO
LINOSA
SALISCENDI**

● LCDQ / LCDT
● LCDQT
● LSX / LSOT

528 SOFFIONI INOX 2 MM. MADE IN ITALY
Shower heads / Duschköpfe / Douche de tête

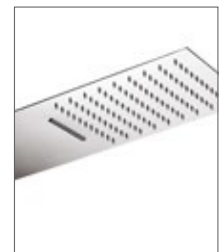

530

SOFFIONI A PARETE
WALL SHOWER HEADS

●● LSPRI - LSPQTI - LSPTI
LSPRI BLACK - LSPQTI
BLACK - LSPTI BLACK



466

SOFFIONI QUADRATI
SQUARE SHOWER HEADS

●● LSQI - LSQI BLACK



464

SOFFIONI TONDI
ROUND SHOWER HEADS

●● LSTI - LSTI BLACK

SOFFIONI INOX 2 MM.

Shower heads / Duschköpfe / Douche de tête



536

WIFI QUADRATI
SQUARE WIFI

● LSSQW



538

WIFI TONDI
ROUND WIFI

● LSSTW



540

INOX SPAZZOLATO
BRUSHED STAINLESS STEEL

● LSSQXB



542

QUADRATO
SQUARE

● LSSQ 2mm

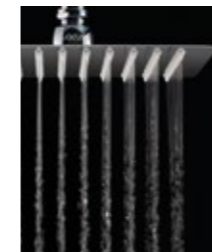

544

RETTANGOLARE
RECTANGULAR

● LSSR 2mm



545

TONDO
ROUND

● LSST 2mm



546

**RETTANGOLARE
ANGOLI STONDATI**
*RECTANGULAR WITH
ROUND EDGES*

● LSSRT



547

OVALE
OVAL

● LSSO 2mm

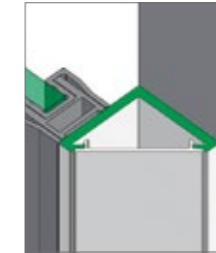

556

PROFILI SPECIALI
SPECIAL PROFILE

●● MTP AG - MTP ANGOLO



557

KIT ANTICALCARE
DESCALING KIT

LKA 100



558

TERGICRISTALLI
WIPERS

LMR / LMT / LTV



561

SEDILI E MANIGLIE
SEATS AND HANDLES

LSDL / MNG

ACCESSORI

Complements / Zubehör / Accessoires



548

BRACCI
ARMS

● LSBQ - LSBQN - LSBO
● LSBT - LSBTN
● LSBSQ - LSBST



550

DOCLETTE
HAND SHOWERS

● LSDQ 01 - LSDQ 01XB
● LSDQ 01B - LSDT 01
● LSDT 01B



552

RACCORDI A MURO
WALL FITTINGS

● LSRMQ 01 - LSRMQ 01XB
● LSRMQ 01B - LSRMT 01
● LSRMT 01B



553

FLESSIBILI
FLEXIBLES

● LSF 150 - LSF 200
● LSF 150XB
● LSF 150B - LSF 200B



554

MISCELATORI
MIXERS

● LSMQ 01 - LSMQ 01XB
● LSMQ 01B - LSMT 01
● LSMT 01B

562

PARTI DI RICAMBIO / SPARE PARTS / ERSATZTEILE / PIÈCES DE RECHANGE

564

INSTALLAZIONE / INSTALLATION / INSTALLATION / INSTALLATION

566

MANUTENZIONE / MAINTENANCE / WARTUNG / ENTRETIEN

568

ASSISTENZA / CUSTOMER SERVICE / KUNDENBETREUUNG / SERVICE APRÈS-VENTE

569

CENTRO DI INSTALLAZIONE LACUS / LACUS INSTALLATION CENTRES
LACUS AUFBAUZENTREN / CENTRES INSTALLATION LACUS

570









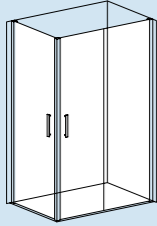
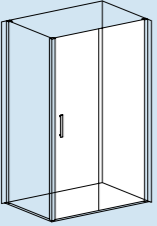
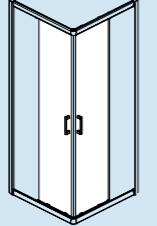
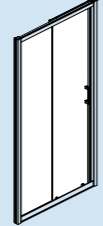
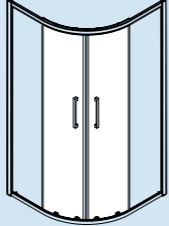
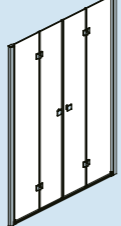

IN CASO DI CONTESTAZIONE / DISPUTE / STREIT / LITIGE

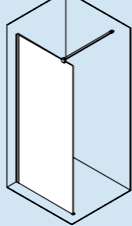
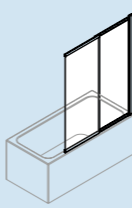
572

CONDIZIONI GENERALI DI VENDITA / GENERAL SALES CONDITIONS
ALLGEMEINE VERKAUFSBEDINGUNGEN / CONDITIONS GENERALES DE VENTE

SISTEMI LACUS.

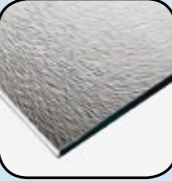
LACUS SYSTEMS
LACUS SYSTEME
SYSTÈMES LACUS

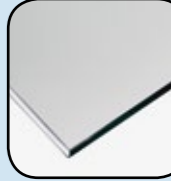
| ANGOLARE BATTENTE | PORTA BATTENTE | ANGOLARE SCORREVOLE | PORTA SCORREVOLE | SEMICIRCOLARE SCORREVOLE | PORTA SALOON | PORTA A LIBRO | WALK-IN | SOPRA VASCA | MATT | FOX | GREY | MIRROR | | | | |
|---|---|---|---|---|---|---|---|---|---|---|---|---|---|---|---|---|
| CORNER PIVOT DOOR. ECKDREHTÜR. PIVOTANTE ANGULAIRE. | PIVOTING DOOR. DREHTÜR. PORTE PIVOTANTE | CORNER SLIDING DOOR. ECKSCHIEBETÜR. COULISSANTE ANGULAIRE. | SLIDING DOOR. SCHIEBETÜR. PORTE COULISSANTE. | SEMICIRCULAR MODEL. HALBKREISFORMIGE MIT SCHIEBETÜR. SEMICIRCULAIRE COULISSANTE. | 180° PIVOTING DOOR. DREHTÜR 180°. PORTE PIVOTANTE 180°. | FOLDING DOOR. FALTBARE TÜR. PORTE PLIANTE. | WALK-IN | BATHTUB SCREEN. BADEWANNEN DUSCHWÄNDE. PARE-BAIGNOIRE. | | | | | | | | |
|  |  |  |  |  |  |  |  |  |  |  |  |  |  |  |  |  |

GIANNUTRI

38

ELBA

S. PIETRO

54

LAMPEDUSA

CAPRAIA

VENEZIA

ALBARELLA

TREMITI

GRADO

MURANO

MONTECRISTO

CAPRI

LA MADDALENA

204

CAPRERA

PANTELLERIA

TORCELLO

SISTEMI LACUS.

LACUS SYSTEMS
LACUS SYSTEME
SYSTÈMES LACUS

ANGOLARE
BATTENTE

PORTA
BATTENTE

ANGOLARE
SCORREVOLE

PORTA
SCORREVOLE

SEMICIRCOLARE
SCORREVOLE

PORTA
SALOON

PORTA
A LIBRO

WALK-IN

SOPRA VASCA

MATT

FOX

GREY

MIRROR

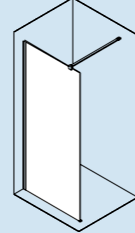
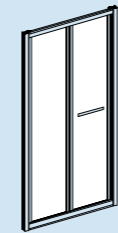
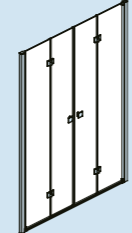
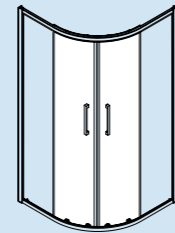
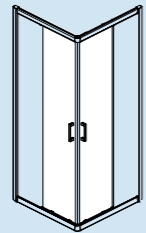
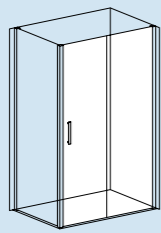
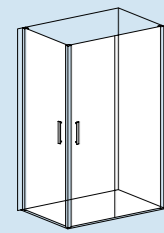

FOLDING DOOR.
FALTBARE TÜR.
PORTE PLIANTE.

WALK-IN

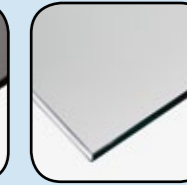
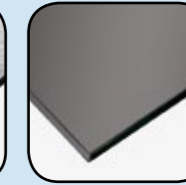
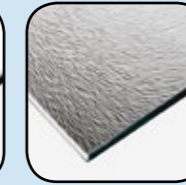
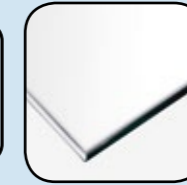
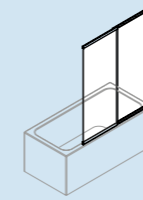

ASINARA

PIANA

EOLIE

VULCANO

LIPARI

STROMBOLI

PONZA EVO

332

PANAREA

ORTIGIA

FORMICA

CAPRI WALL

FILICUDI

TREMITI WALL

418

ALICUDI WALL

SALINA

LEVANZO

MARETTIMO EVO

FAVIGNANA

PARETI DOCCIA

Le pareti doccia LACUS sono conformi alle normative introdotte con il regolamento (UE) nr° 305/2011. L'attuazione del suindicato regolamento è garantita dall'applicazione da parte di LACUS della norma armonizzata EN14428:2004 + A1:2008 (pareti doccia - requisiti funzionali e metodi di prova). In particolare la norma richiede la verifica sul prodotto mediante idonee prove delle caratteristiche di pulibilità, resistenza agli urti, resistenza alla corrosione, resistenza agli agenti chimici e alle macchie, resistenza ai cicli umido/secco, durata ai cicli di apertura/chiusura delle ante, stabilità secondo norma ISO7892:1988 e tenuta all'acqua.

Attrezzature e strumenti computerizzati sottopongono i prodotti LACUS ai più severi test di:

DURATA DEI CICLI IN APERTURA/CHIUSURA

La resistenza e la durata delle ante è verificata da un test di apertura e chiusura della durata di 20.000 cicli.

RESISTENZA DEI PROFILI ALLA CORROSIONE

La resistenza della verniciatura sui profili è verificata da una prova denominata "quadrettatura". Per mezzo di lame taglienti si provocano profonde incisioni fra loro perpendicolari sulla superficie del profilo formando un numero stabilito di quadrati: il test è superato solo a condizione che si stacchino al massimo due quadrati.

RESISTENZA DEI PANNELLI IN CRISTALLO AGLI AGENTI CHIMICI ED ALLE MACCHIE

L'inalterabilità della struttura molecolare e dell'aspetto estetico dei cristalli è verificata da una prova di aggressione da parte di un reagente chimico su di un campione di cristallo di 100x100 mm, per circa 2 ore: il test è superato a condizione che, dopo il risciacquo, il campione non presenti alcun deterioramento, macchia o abrasione.

SICUREZZA DELLA CABINA

La sicurezza per l'utilizzatore è garantita da un test che simula l'urto di un corpo umano sulla parete doccia. Un corpo contundente viene lasciato cadere all'interno di ogni singola parete della cabina doccia: il test è superato se le pareti doccia non presentano deterioramenti funzionali che potrebbero causare lesioni all'utilizzatore.

TENUTA ALL'ACQUA

Anche in condizioni estreme di utilizzo, la tenuta delle giunzioni, delle guarnizioni e dei sigillanti è verificata da un test che consiste nel rivolgere getti d'acqua ad alta pressione verso le zone critiche della cabina doccia.

PROVA DI FRAMMENTAZIONE DEI VETRI

La normativa prevede che, in caso di rottura, i frammenti di cristallo siano più piccoli della misura massima consentita al fine di salvaguardare la sicurezza dell'utilizzatore.

SHOWER ENCLOSURES

Shower enclosures by LACUS comply with the norms introduced by UE Regulation No. 305/2011. The implementation of the aforementioned Regulation is met by the application by LACUS of the harmonized Standard No. EN 14428:2004 + A1:2008 (Shower Enclosures – Functional requirements and tests methods). The Standard requires, in particular, the check of the enclosure by means of specific tests about cleaning characteristics, shock resistance, resistance to corrosion, resistance to chemicals and stains, resistance to wet/dry cycles, strength of the doors to opening/closing cycles, stability according to Regulation No. ISO7892:1988 and water tightness.

Equipment and computerized instruments put Lacus products through the severest tests regarding:

OPENING AND CLOSING CYCLES LIFE

The strength and the endurance of the doors are verified by an opening and closing test lasting 20,000 cycles.

PROFILES RESISTANCE TO CORROSION

The painting resistance on the profiles is verified by a test called "grid".

Sharp blades cause deep perpendicular cuts on the profile surface forming a set number of squares.

The test is passed only if not more than two squares come loose.

CRYSTAL PANELS RESISTANCE TO CHEMICALS AND STAINS

The endurance of the molecular structure and the crystals appearance are checked testing a chemical reagent on a 100x100 mm crystal sample for about two hours.

The test is passed only if, after rinsing, the sample shows no deterioration, stain or abrasion.

CABIN SAFETY

The security of the cabin is ensured by a test that simulates the impact of a human body on the shower wall.

A blunt object is dropped inside each wall of the shower unit. The test is passed only if the shower walls do not show functional deterioration which can cause damages to the user.

WATER TIGHTNESS

Even under extreme conditions of use, the seal of the joints, the gaskets and the sealants is verified by a test that consists in directing high-pressure jets of water at the critical areas of the shower unit.

GLASSES FRAGMENTATION TEST

The rule stipulates that, in case of breakage, the crystal fragments are smaller than the maximum allowed extent so as to guarantee the security of the user.

ECK-DUSCHKABINE

Die Dusch-Kabinen von LACUS entsprechen die Normen der EU-Verordnung Nummer 305/2011. Von Lacus wird die Durchführung der o.g. Verordnung durch die Anwendung der harmonisierten Norm EN 14428 Nummer. : 2004 + A1: 2008 (Duschkabinen - Funktionsanforderungen und Prüfverfahren) versichert. Insbesondere verlangt der Standard die Überprüfung der Kabinen durch spezifischen Tests zu Reinigungseigenschaften , Stoßfestigkeit, Korrosionsbeständigkeit , Beständigkeit gegen chemische Mittel und Flecken , Beständigkeit gegen Nass- / Trocken -Zyklen , Beständigkeit der Türen gegen Öffnen / Schließen -Zyklen, Stabilität nach der Regelung Nummer ISO7892: 1988 und Wasserdichtigkeit.

Mithilfe geeigneter Werkzeuge und computerisierter Instrumente unterziehen wir die LACUS Produkte strengsten Tests auf folgende Eigenschaften:

BESTÄNDIGKEIT DER TÜREN

Die Belastbarkeit und Langlebigkeit der Türen wird durch 20.000 Zyklen öffnen und schließen derselben getestet.

KORROSIONRESISTENZ DER PROFILE

Die Widerstandsfähigkeit der Lackierung auf den Profilen wird durch einen Test erprobt, der sich „Quadratierung“ nennt.

Mithilfe scharfer Klingen werden tiefe, zueinander rechtwinklig stehende Schnitte in die Profile geritzt, welche eine vorgegebene Anzahl von Quadraten bilden: der Test gilt als bestanden, wenn sich maximal zwei Quadrate lösen.

BESTÄNDIGKEIT DER KRISTALLGLASWÄNDE GEGEN CHEMISCHE MITTEL UND FLECKEN

Die Unveränderlichkeit der Molekularstruktur und des ästhetischen Aspekts der Glasscheiben wird erprobt mithilfe eines chemischen Reaktionsmittels, welches für 2 Stunden auf einem Muster der Größe 100x100 mm belassen wird: der Test gilt als bestanden, wenn nach dem Abspülen des Mittels keinerlei Verschleiß, Flecke oder Schmirgelspuren vorhanden sind.

SICHERHEIT DER KABINE

Die Sicherheit des Benutzers ist garantiert durch einen Test, der den Aufprall eines menschlichen Körpers auf eine Duschwand simuliert. Ein Schlagkörper wird gegen jede einzelne Wand der Duschkabine fallen gelassen: der Test gilt als bestanden, wenn die Duschwände keine funktionellen Beschädigungen aufweisen, die dem Benutzer Verletzungen zufügen könnten.

WASSERDICHTHEIT

Auch unter extremen Benutzungsbedingungen ist die Dichtheit der Verbindungsstücke, der Dichtungen und der Fugen nachgewiesen, durch einen Test, bei dem ein Hochdruckwasserstrahl auf die kritischen Bereiche der Duschkabine gerichtet wird.

SPLITTERTEST DER SICHERHEITSGLASSCHEIBEN

Die Norm sieht vor, daß, im Fall vom Bruch, die Bruchstücke kleiner als die maximal zugelassene Größe sein müssen, um die Sicherheit des Benutzers zu garantieren.

CABINE DE DOUCHE

Les parois de douche LACUS respectent les normes introduites par le règlement européen n° 305/2011. La mise en œuvre du règlement précité est assurée par l'application de la part de LACUS de la norme harmonisée EN 14428 no: 2004 + A1: 2008 (cabines de douche - exigences fonctionnelles et méthodes d'essai). La norme exige, en particulier, la vérification de la cabine au moyen de tests spécifiques sur les caractéristiques de nettoyage, résistance aux chocs, résistance à la corrosion, résistance aux produits chimiques et aux taches, résistance à des cycles sec/mouillé, résistance des volets à des cycles d'ouverture / fermeture, la stabilité conformément au Règlement no ISO7892: 1988 et l'étanchéité à l'eau.

Les équipements et les instruments informatiques soumettent les produits Lacus aux tests les plus sévères de:

DUREE DES CYCLES OUVERTURE/FERMETURE

La résistance et la durée des volets sont vérifiées par un test de 20.000 cycles ouverture/fermeture.

RESISTANCE DES PROFILES A LA CORROSION

La résistance de la peinture des profilés est vérifiée par un test appelé: Quadrillage. Avec des lames coupantes on va faire des incisions profondes et perpendiculaires les unes aux autres sur le revêtement formant un nombre prédéterminé de carrés. Le test est validé à la seule condition que "au maximum" 2 carrés se détachent.

RESISTANCE DES PANNEAUX DE VERRE AUX AGENTS CHIMIQUES ET AUX TACHES

La conservation de la structure moléculaire et de l'aspect esthétique des verres est vérifiée par l'essai d'agression. Sur un échantillon de verre de 100x100 mm on va mettre un réactif chimique pendant à peu près 2 heures: le test est validé si, après le rinçage, l'échantillon ne présente ni détérioration, ni tache, ni abrasion.

SECURITE DE LA CABINE

La sécurité pour l'utilisateur est garantie par un test qui simule le choc d'un corps humain sur la paroi de la douche. Un corps contondant est laissé tomber à l'intérieur de chaque paroi de la cabine douche : le test est validé si les parois de la douche ne présentent aucune détérioration fonctionnelle qui pourrait causer des lésions à l'utilisateur.

ETANCHEITE

Même en conditions extrêmes d'utilisation, l'étanchéité est vérifiée par un test qui consiste à diriger des jets d'eau à haute pression vers les zones critiques de la cabine douche.

TEST DE FRAGMENTATION DES VERRES

La réglementation prévoit que, en cas de rupture, les fragments de verre soient plus petits que la mesure maximale prévue afin de sauvegarder la sécurité de l'utilisateur.

PROVA DI QUALITA'

QUALITY TEST
QUALITÄTSTEST
ESSAI DE QUALITÉ

CERTIFICATIONS
ZERTIFIZIERUNGEN
CERTIFICATIONS

CERTIFICAZIONI

I test di qualità rispettano la NORMA ARMONIZZATA EN 14428:2004 + A1:2008 (pareti doccia – requisiti funzionali e metodi di prova).

The quality tests meet the harmonized standard EN 14428:2004 + A1: 2008 (Shower panels - Functional requirements and test methods).

Die Qualitätstesten respektieren die harmonisierte Norm EN 14428: 2004 + A1:2008 (Duschen - Funktionsanforderungen und Prüfverfahren).

Les tests de qualité mettent en œuvre la norme harmonisée EN 14428:2004 + A1:2008 (paroi de douche - exigences fonctionnelles et méthodes d'essai).

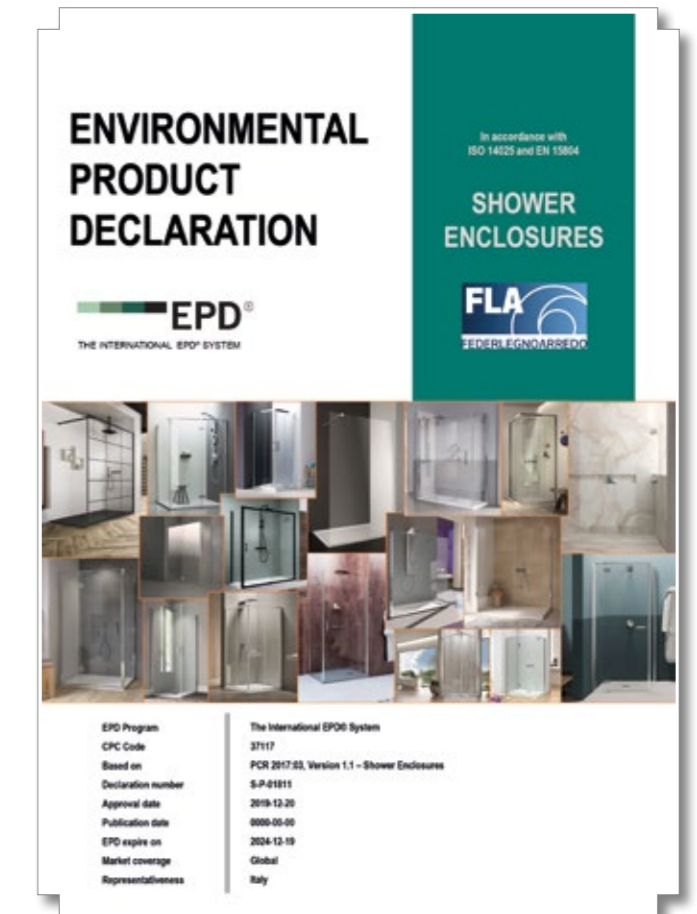

- Test di spruzzo acqua salata
- Salty spray test
- Salziger Spritztest
- Test du jet salé



- Test di carico
- Load weight test
- Testlastgewicht
- Test de la résistance au poids



- Prova di apertura (20.000 cicli)
- Wheel pp test (20.000 times)
- Test des Rades pp. (20.000 mal)
- Test de la roue pp (20.000 fois)



- Prova di urto
- Impact test
- Schlagpruefung
- Test au choc



- Prova di tenuta
- Leakage test
- Wasserdruckpruefung
- Test d'étanchéité

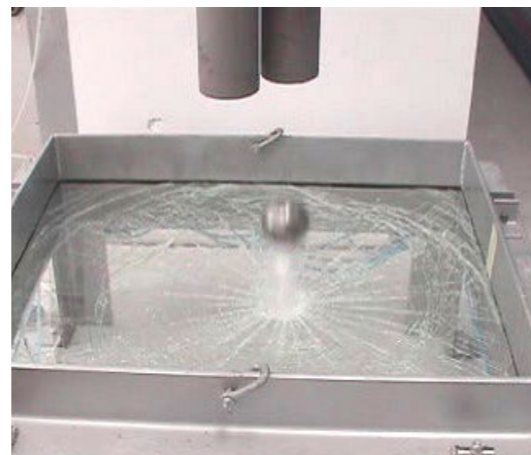

- Prova rottura cristalli
- Breaking test
- Stahlball-Schlagversuch
- Test de rupture des verres

OWNER COMPANIES

| | |
|--|--|
| | Inda the story of a successful Italian company driven by a true entrepreneurial spirit. Inda is an industrial group with a well established leadership in the international markets, 70 years of experience dedicated to the support of the customers, the expertise of Inda is based on a deep competence to learn and to understand the needs and the tastes of the diverse markets which change and evolve continuously. Creativity, originality and distinctive elegance are elements which identify and express the design of Inda. |
| | Established in 2008, Lacus has its headquarters in Sassuolo Modena. Lacus designs its own range of shower enclosures, standing out for innovative solutions, with international patents such as Quick Installation in 2014 and Capri in 2018. Harmony, Emotion and Innovation are LACUS' designers' targets. In the context of the Customer Satisfaction Program, LACUS introduced "Shop on-line" and now, the retail customers can connect anytime and anywhere in order to check availabilities and place orders. |
| | The Novellini Group is European leader in the production of shower enclosures, complete cubicles and whirlpool baths, with plants in Italy and France, branch offices in major European countries and sales offices around the world. Family values underlie and steer the Novellini family business. Generation after generation, Passion and commitment, innovation and creativity, as well as a relentless attention to the customer needs, these are the values Novellini pursues. |
| | Megius, since 1976, has been producing and promoting unique shower solutions that are affordable to anyone, designed to represent the Italian high school bathroom furniture in bathrooms in Italy and around the world. In more recent times it has also been synonymous with a wellness product, as the feeling of feeling good at home and in spaces outside of your home is increasingly widespread. |

OWNER COMPANIES

| | |
|--|---|
| | RARE was born in 1965 in Calate, Varese, northern Italy. In 1983, thanks to the founder, Renato Ravarino, RARE began producing shower enclosures, introducing four fundamental elements: design, quality, functionality and safety. In 2015, RARE becomes the Quality Management System (UNI EN ISO 9001). Uses the best and eco-compatible materials: aluminum, glass, steel, 100% recyclable. The shower enclosures are CE marked, according to the UNI EN 14428: 2015 directive. |
| | With over 250 employees, 55,000 square meters of production facilities spread over 4 sites, which generate a production capacity of 2,000 shower cabins per day, the Samo Group is recognized as a leading player in the sector. In Italy, Samo is a widespread distribution, secured by virtue of a branch structure in France, Spain and distributors that expand their presence around the world. All our products are designed, processed and assembled in our factory in Bussanigo (VR) while the glass sheets are produced in our glass factory in Poggiana (BO). |
| | Vismarvetro is a leading Italian company, specialized in the integrated production of tempered glass shower enclosures, with standard and at the same time flexible and customized products. Vismarvetro is the only Italian manufacturer of shower enclosures that combines also glass production. Thanks to the historical and continuous experience, Vismarvetro is able to respect its customer requests. The company is therefore specialized in the production of both conventional high quantities and individual orders. |

OWNER COMPANIES

| | |
|--|--|
| | Arblu, present on the market since 1986, has a dynamic and creative 100% experience in the production of bathroom and kitchen products. A real focus on innovation and attention to the real living dynamics. Through its wide range of products, Arblu today represents the Made in Italy solution for the needs of harmony and well-being of the contemporary bathroom. |
| | Calibe, close to Bologna, is well established in the district where Italian engineering skills exist. Each product, along with the made in Italy values, bears the company's design philosophy. |
| | Our slogan "shower emotion" is the heart of our activities: individual tailor-made projects, high quality raw materials and innovative technological lines merged all along the beginning. Products that represent the integration of comfort and versatility, practical and elegant, sturdy and functional. We offer solutions for the home and various types of glass on site to highlight the characteristics of the shower enclosure. We carry out "shower emotion". |

Chiusure Doccia

Shower Enclosures - Duschkabinen - Cabines de douche

- **ALLUMINIO E ACCIAIO INOX 304**

I profili di alluminio sono realizzati con materie prime di altissima qualità. Ogni singolo profilo è preventivamente tagliato e forato, permettendo così ai successivi trattamenti di coprire ogni parte del pezzo, garantendo una qualità duratura nel tempo. La verniciatura viene effettuata attraverso impianti tecnologici all'avanguardia; ogni profilo subisce un pretrattamento di sgrassaggio e fosfocromatazione prima di essere verniciato con polveri epossidiche le quali, applicate elettrostaticamente su tutta la superficie del profilo, polimerizzano formando uno strato resistente ed inalterabile nel tempo. Brillantatura e satinatura sono ottenute a mezzo di processi chimici preceduti da accurata spazzolatura dei profili per renderli resistenti e duraturi nel tempo.

- **CRISTALLO**

Il cristallo LACUS è trattato con sistema di temperatura per aumentare la resistenza e garantire il più alto grado di sicurezza tecnologicamente raggiungibile. In caso di accidentale rottura, la lastra si sbriciola in piccolissimi frammenti inoffensivi.

- **ALUMINIUM AND STAINLESS STEEL 304**

The aluminum profiles are made with high quality raw materials. Each profile is cut and drilled in advance so as to allow the subsequent treatments to cover every part of the item ensuring lasting quality over time. The painting is carried out in leading high tech plants. Each profile undergoes, before being coated with epoxy powders, a degreasing and phosphocromatizing pre-treatment by which the powder covers electrostatically the whole surface of the profile and polymerizes thus forming a resistant and unalterable layer. Resistant and lasting shiny and/or satin finish are obtained by means of chemical processes preceded by a careful brushing of the profiles.

- **CRYSTAL**

Lacus crystal is treated with a tempering system in order to increase the resistance and guarantee the highest security level technologically attainable. In case of accidental breakage, the sheet crumbles into tiny harmless fragments.

- **ALUMINIUM UND EDELSTAHL 304**

Die Aluminiumprofile sind aus Grundstoffen allerhöchster Qualität gefertigt. Jedes einzelne Profil wird im Voraus geschnitten und gebohrt, um bei den darauffolgenden Behandlungen jede Fläche des Stücks bedecken zu können; dieses Verfahren garantiert eine langlebige Qualität. Die Lackierung wird mittels Anlagen, die auf dem neuesten technologischen Stand sind, vorgenommen; jedes Profil erfährt eine Vorbehandlung durch Entfettung und Phosphocromatisierung, bevor es mit Epoxid-Pulvern beschichtet wird, welche elektrostatisch auf die gesamte Oberfläche des Profils aufgetragen werden und dadurch polymerisieren, und sich so zu einer widerstandsfähigen und langlebigen Schicht verdichten. Politur und Satinierung werden durch chemische Prozesse erzielt, denen eine akkurate Bürstung vorausgeht, womit die Profile widerstandsfähig und langlebig gemacht werden.

- **KRISTALLGLAS**

Das Kristallglas von Lacus wird mit einem Prozess der Temperatur behandelt, um den Widerstand zu vergrößern und den höchsten erreichbaren Sicherheitsgrad technologisch zu garantieren. Im Falle zufälligen Zerbreches zerkrümelt sich die Kristallglasscheibe in zwerghaften harmlosen Bruchstücken.

- **ALUMINIUM ET ACIER INOXYDABLE 304**

Les profilés sont fabriqués avec des matières premières de très grande qualité. Chaque profilé est d'abord coupé et troué, ce qui permet aux traitements successifs de couvrir entièrement la pièce, garantissant une qualité durable. Le vernissage est effectué par une installation technologique d'avant-garde; chaque profilé subit un prétraitement de dégraissage et de phosphochromage avant d'être verni avec des poudres époxydiques qui, appliquées électrostatiquement sur toute la surface, polymérisent formant un revêtement résistant et inaltérable. Le lustre et le satinage sont obtenus par procédés chimiques précédés par un brossage minutieux des profilés pour les rendre résistants et durables.

- **VERRE**

Le verre LACUS est traité avec un système de trempe thermique pour augmenter la résistance et garantir le plus haut degré de sécurité réalisable technologiquement. En cas de rupture accidentelle, la plaque se brise en morceaux minuscules et inoffensifs.



- **Cristallo trasparente**
- Transparent crystal
- Transparentes Kristallglas
- Verre transparent



- **Cristallo Matt**
- Matt crystal
- Satiniertes Kristallglas
- Verre mat



- **Cristallo Grey**
- Grey crystal
- Graues Kristallglas
- Verre fumé

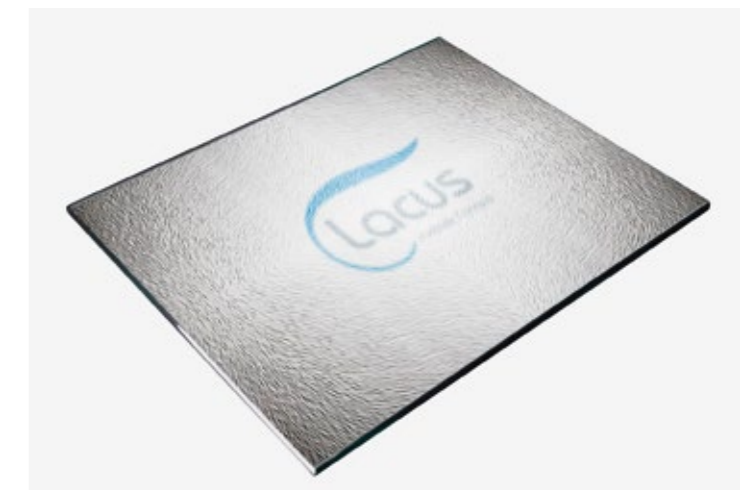

- **Cristallo Fox**
- Fox crystal
- Fox Kristallglas
- Verre granité



- **Cristallo specchiato**
- Mirror crystal
- Spiegel-Kristallglas
- Cristal miroir

Piatti Doccia Shower trays - Duschtassen - Receveurs

MARFIL / SLATE EVO / BRECCIA / PETRA:

- Piatti doccia Marfil, Slate Evo, Breccia, Petra sono realizzati in polvere di marmo, carbonato di calcio, quarzo e resina, il corpo del piatto doccia è colorato in pasta.
- *Marfil, Slate Evo/Breccia/Petra shower trays are made of marble powder, calcium carbonate, quartz and resin. Body is colored.*
- *Marfil, Slate Evo/Breccia/Petra Duschtassen sind aus Marmorpulver, Kalziumcarbonat, Quarz und Harz. Ihre Körper ist farbig.*
- *Les receveurs „Marfil, Slate Evo-Breccia-Petra“ sont fabriqués en poudre de marbre, carbonate de calcium, quartz et résine. Ils sont colorés dans la masse.*

LIMESTONE:

- I piatti doccia Limestone sono realizzati in polvere di marmo, carbonato di calcio, quarzo e resina.
- *The shower trays Limestone are made of marble powder, calcium carbonate, quartz and resin*
- *Die Limestone Duschtassen sind aus Marmorpulver, Kalziumkarbonat, Quarz und Harz hergestellt.*
- *Les receveurs sont fabriqués en poudre de marbre, carbonate de calcium, quartz et résine.*

WHITE SILK / BLACK SILK / STONELITE:

- Realizzato in carbonato di calcio e resina poliestere insatura. La superficie in gel coat è antiscivolo.
- *Made of calcium carbonate and unsaturated polyester resin. The gelcoat surface is anti slip.*
- *Aus Kalziumkarbonat und ungesättigten Polyesterharzen hergestellt. Die Oberfläche aus Gelcoat ist rutschfest.*
- *Fabriqué en carbonate de calcium et résine polyester insaturée. La surface en gel coat est antidérapante.*

SLIM:

- Realizzato in SMC (Vetroresina) composto da fibre di vetro, cariche minerali, pigmenti e resine poliesteri insature.
- *Made of fiberglass (SMC), consisting of glass fibers, minerals fillers, pigments and unsaturated polyester resins.*
- *Aus Kunststoff (SMC) aus Glasfasern, mineralischen Füllstoffen, Pigmenten und ungesättigten Polyesterharzen hergestellt.*
- *Fabriqué avec des résines polyester (SMC), des fibres de verre, des charges minérales, des pigments et des résines polyester insaturées.*



- **Polvere di Marmo**
- *Marble powder*

- *Marmorpulver*
- *Poudre de Marbre*



- **Carbonato di calcio**
- *Calcium Carbonate*

- *Kalziumkarbonat*
- *Carbonate de Calcium*



- **Quarzo**
- *Quartz*

- *Quarz*
- *Quartz*

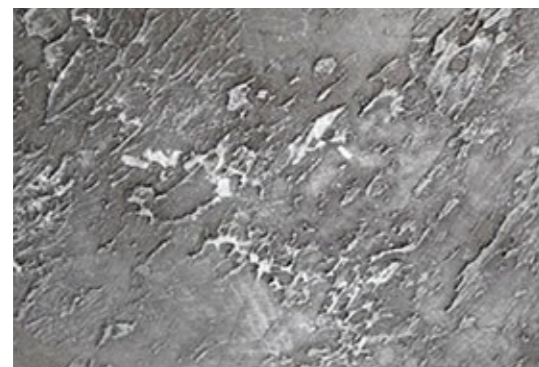

- **Resina**
- *Resin*

- *Harz*
- *Résine*



- **Vetroresina**
- *Fiberglass*

- *Glasfaserverstärkter Kunststoff*
- *Fibre de verre*

Complementi Doccia Shower accessories - Dusch Zubehör - Accessoires de douche

- **Acciaio Inox 304 e Ottone cromato 800/1000**
- *Stainless Steel 304 and chrome coated brass 800/1000*
- *Rostfreier Stahl 304 und verchromtes Messing 800/1000*
- *Acier inoxydable 304 et laiton chromé 800/1000*



- **Acciaio Inox 304**
- *Stainless Steel 304*
- *Rostfreier Stahl 304*
- *Acier Inoxydable 304*



- **Acciaio spazzolato**
- *Brushed stainless steel*
- *Gebürsteter Stahl*
- *Acier Inoxydable*

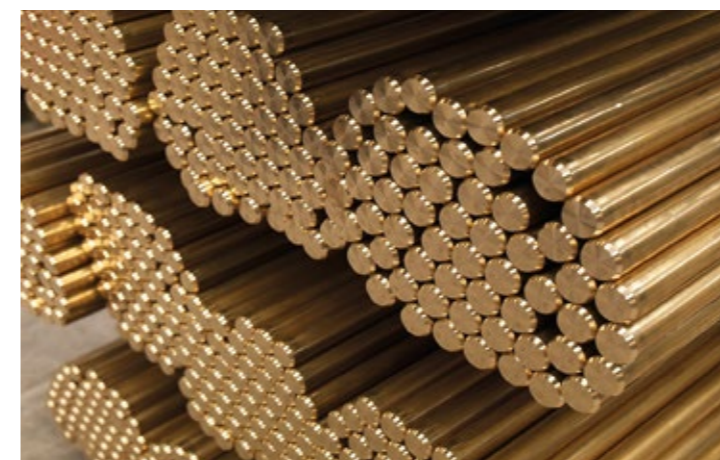

- **Ottone cromato**
- *Chrome coated brass*
- *Verchromtes Messing*
- *Laiton chromé*

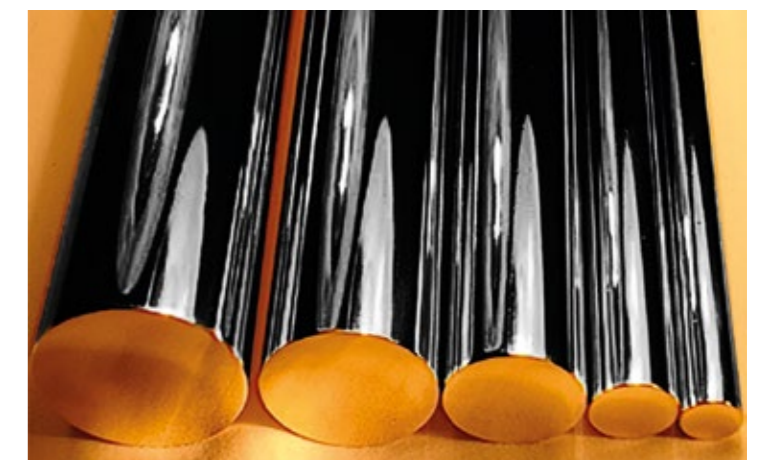

- **Ottone laccato**
- *Coated brass*
- *Lackiertes Messing*
- *Laiton*

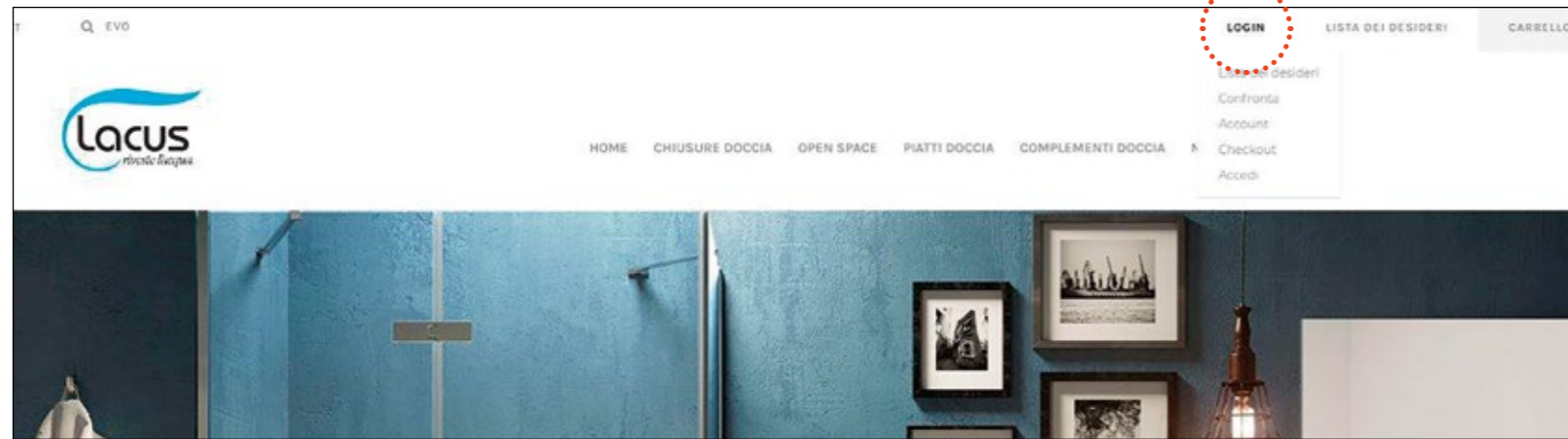

A - Collegarsi al sito www.lacus.it ed entrare nel pannello di accesso cliccando su **ENTRA**.

- Connect to the web page www.lacus.it and click "ENTER".
- Verbinden Sie sich mit Web-Seite www.lacus.it und klicken Sie auf "Login".
- Se connecter à la page web www.lacus.it et cliquer sur "Login".

B - Accedere con le credenziali fornite da Lacus (e-mail e password).

- Access using e-mail and password provided by Lacus. (e-mail and password)
- Login mit ID (E-Mail-Adresse) und Passwort von Lacus übermittelt.
- Entrer les identifiants de connexion fournis par Lacus (email et mot de passe).

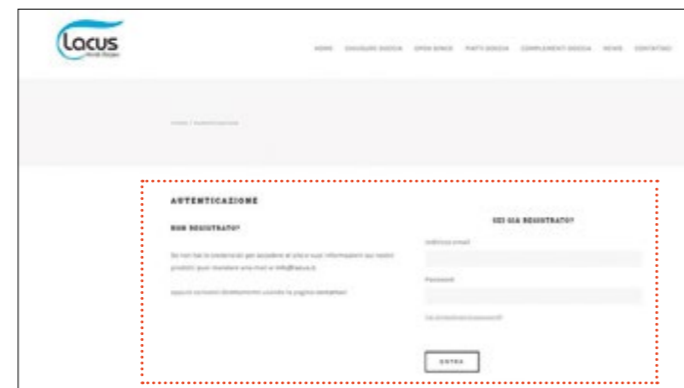

C - "Il mio account" dove si potrà accedere ai diversi servizi, tra cui la novità "Download fatture".

- "My account" where you can access the various services, including the new "Download invoices".
- "Mein Konto", wo Sie auf die verschiedenen Dienste zugreifen können, einschließlich der neuen "Rechnungen herunterladen".
- "Mon compte personnel" pour accéder aux différents services, la nouveauté "Download Fatture" téléchargement des factures.



1 - Selezionare una categoria di prodotto dal menù in alto quindi cliccare sul tipo di prodotto desiderato e procedere con l'acquisto.

- Select a product category from the top menu then click on the desired product and proceed with the purchase.
- Wählen Sie eine Produktkategorie aus dem oberen Menü. Klicken Sie dann auf das gewünschte Produkt an mit dem Kauf fortzufahren.
- Sélectionner une catégorie de produits dans le menu en haut de page puis cliquer sur le produit désiré et terminer l'achat.

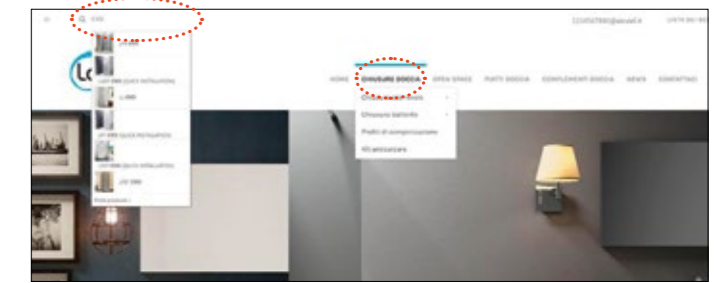

2 - Dopo aver selezionato variante, tipologia/misura e quantità desiderata, cliccare "aggiungi al carrello".

- Add item to cart after selecting the quantity, the finish and then click on "buy".
- Nach Auswahl des Artikels nach Variante, Größe und Menge klicken Sie "in den Warenkorb hinzufügen" an.
- Ajouter le produit au panier d'achat après avoir sélectionné la quantité et le modèle, cliquer enfin sur "acheter".

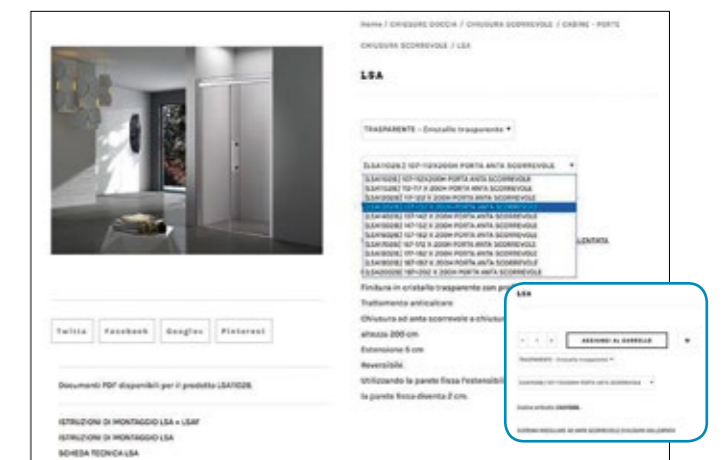

3 - Cliccare il carrello in alto a destra per confermare l'ordine : verrà visualizzato il totale.

- Click the cart in the upper right corner to confirm your order: you'll see the total amount.
- Klicken Sie auf den „Warenkorb“ rechts oben an. Der gesamte Betrag wird gezeigt um die Bestellung zu kontrollieren und zu bestätigen.
- Cliquer sur le panier en haut à droite pour confirmer votre commande : apparaît le total.

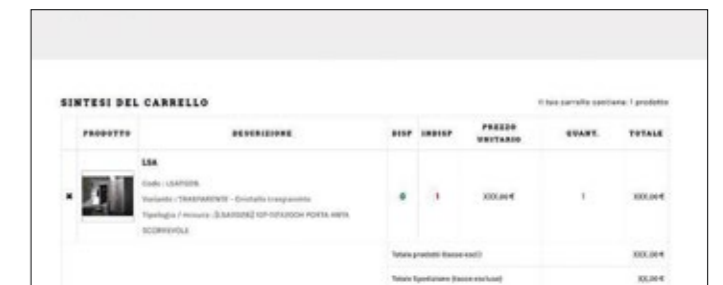

4 - Scorrere verso la parte bassa della pagina, selezionare modalità di consegna.

- Scroll to the bottom of the page, select address and kind of delivery.
- Scrollen Sie die Seite runter und Art der Lieferung wählen.
- Faire défiler la page vers le bas, sélectionner l'adresse et le mode de livraison.



5 - Conferma finale.

- Final confirmation.
- Endgültige Bestätigung der Bestellung.
- La confirmation finale.





| PARETE FISSA SIDE - SEITE - PAROI FIXE | LATO PORTA DOOR - TÜR - COTE PORTE | BOX COMPLETO BOX - DUSCHKABINE CABINE DE DOUCHE | VETRO SOPRA MURETTO GLASS ON THE WALL GLAS AUF DER WAND - VERRE SUR MURET |
|---|---------------------------------------|---|---|
| | | | |
| ALTEZZA inferiore Lower HEIGHT | ALTEZZA inferiore Lower HEIGHT | ALTEZZA inferiore Lower HEIGHT | ALTEZZA inferiore Lower HEIGHT |
| | | | |
| LARGHEZZA inferiore Smaller WIDTH | LARGHEZZA inferiore Smaller WIDTH | LARGHEZZA inferiore Smaller WIDTH | LARGHEZZA inferiore Smaller WIDTH |
| | | | |
| LARGHEZZA superiore Larger WIDTH | LARGHEZZA superiore Larger WIDTH | LARGHEZZA superiore Larger WIDTH | LARGHEZZA superiore Larger WIDTH |
| | | | |

Modulo di richiesta disponibile online sul sito www.lacus.it - In caso di annullamento dopo l'accettazione, sarà addebitato il costo totale dell'ordine.
Application form available online at www.lacus.it - In the event of cancellation after acceptance, the total amount of the order will be charged.

"A" - Spazio in nicchia Wall to wall - Nische - Niche

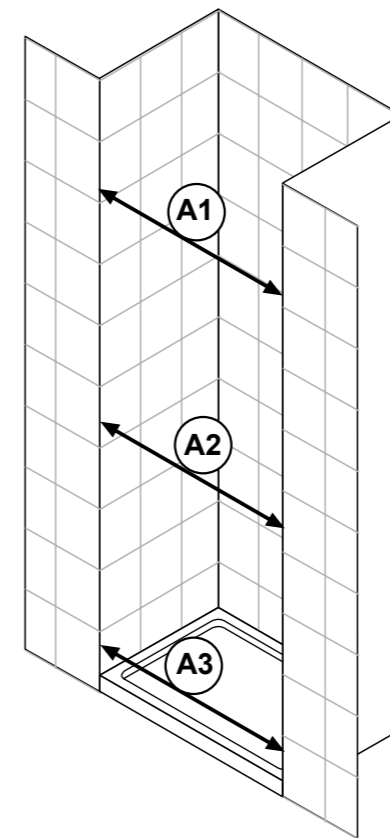

A1 - cm ...
A2 - cm ...
A3 - cm ...



"B" - Cabine ad angolo Corner shower enclosure - Eck-Duschkabine - Cabine de douche en angle

Corner shower enclosure - Eck-Duschkabine - Cabine de douche en angle

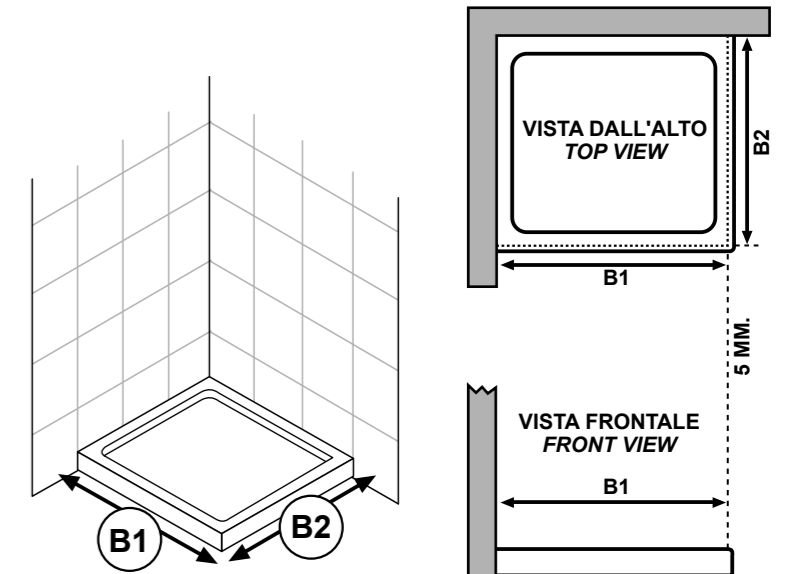

B1 - cm ...
B2 - cm ...



"C" - Spazio in nicchia semi incassata Semi-recessed Wall-to-wall - Halb-versenkte Nische - Niche semi-encastrée

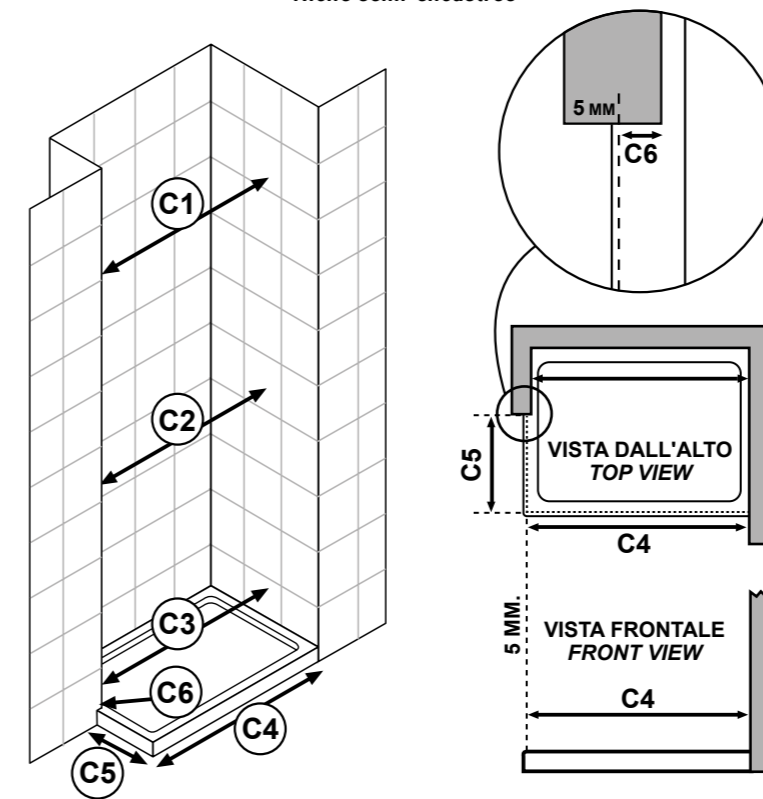

C1 - cm ... C4 - cm ...
C2 - cm ... C5 - cm ...
C3 - cm ... C6 - cm ...



"D" - Spazio in nicchia semi incassata Semi-recessed Wall-to-wall - Halb-versenkte Nische - Niche semi-encastrée

Semi-recessed Wall-to-wall - Halb-versenkte Nische - Niche semi-encastrée

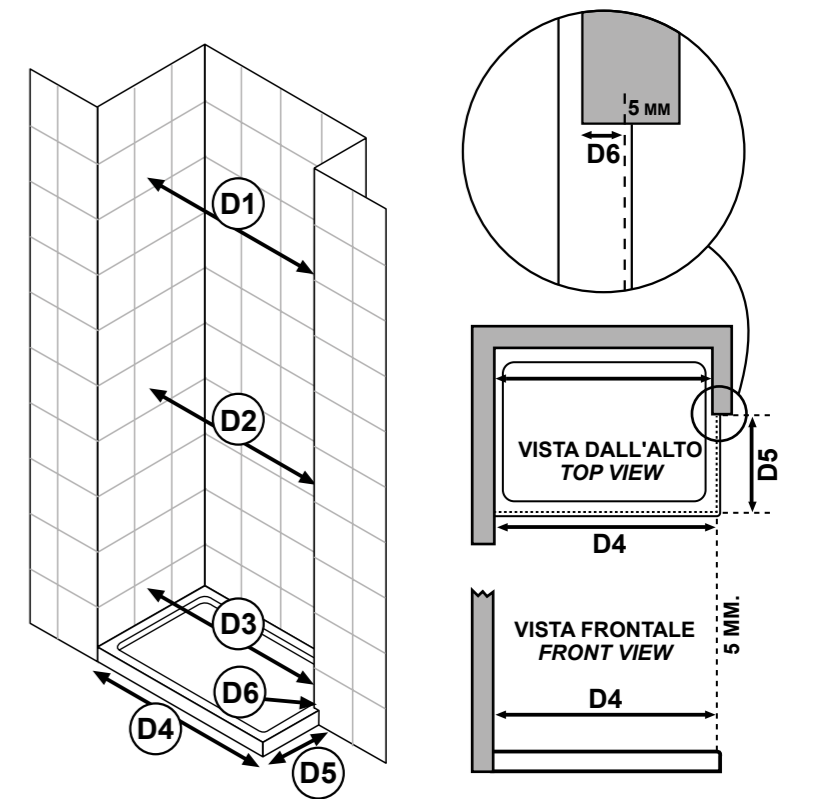

D1 - cm ... D4 - cm ...
D2 - cm ... D5 - cm ...
D3 - cm ... D6 - cm ...



COME RILEVARE LE MISURE

"E" - Spazio in angolo semi incassata Sx
 Corner shower enclosure, semi-recessed to the left.
 Halb-versenkte Eck-Duschkabine, links.
 Cabine de douche en angle semi-encastrée à gauche.

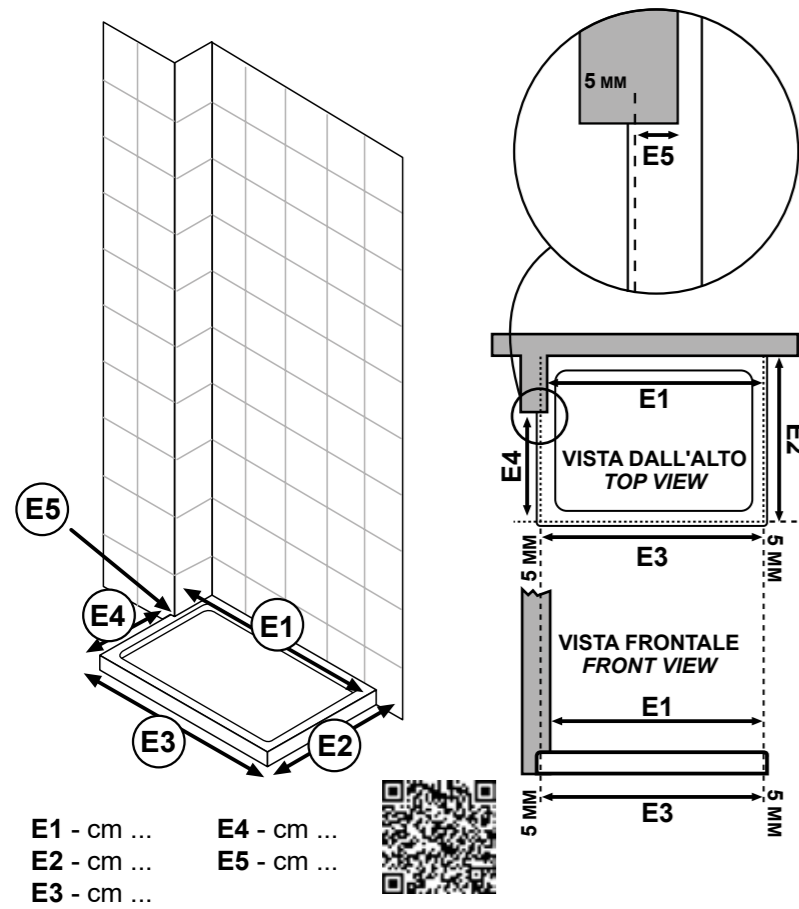

"F" - Spazio in angolo semi incassata Dx
 Corner shower enclosure, semi-recessed to the right.
 Halb-versenkte Eck-Duschkabine, rechts.
 Cabine de douche en angle semi-encastrée à droite.

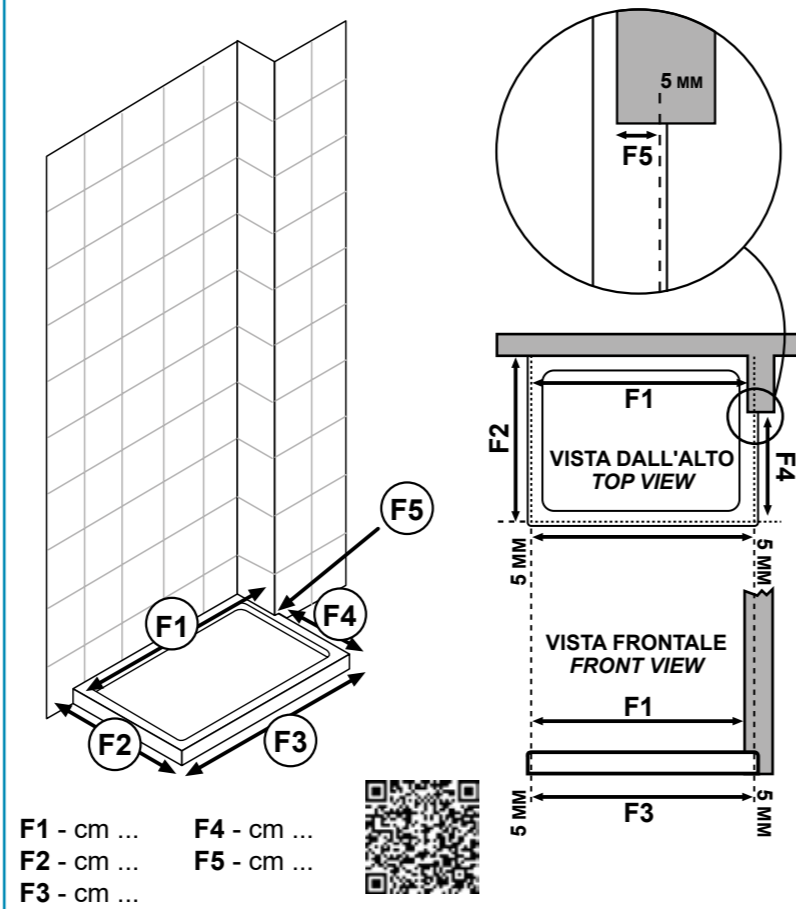

"L" - Spazio in angolo con muretto Sx
 Corner shower enclosure with low wall to the left.
 Eck-Duschkabine mit niedriger Mauer links.
 Cabine de douche en angle avec muret bas à gauche.

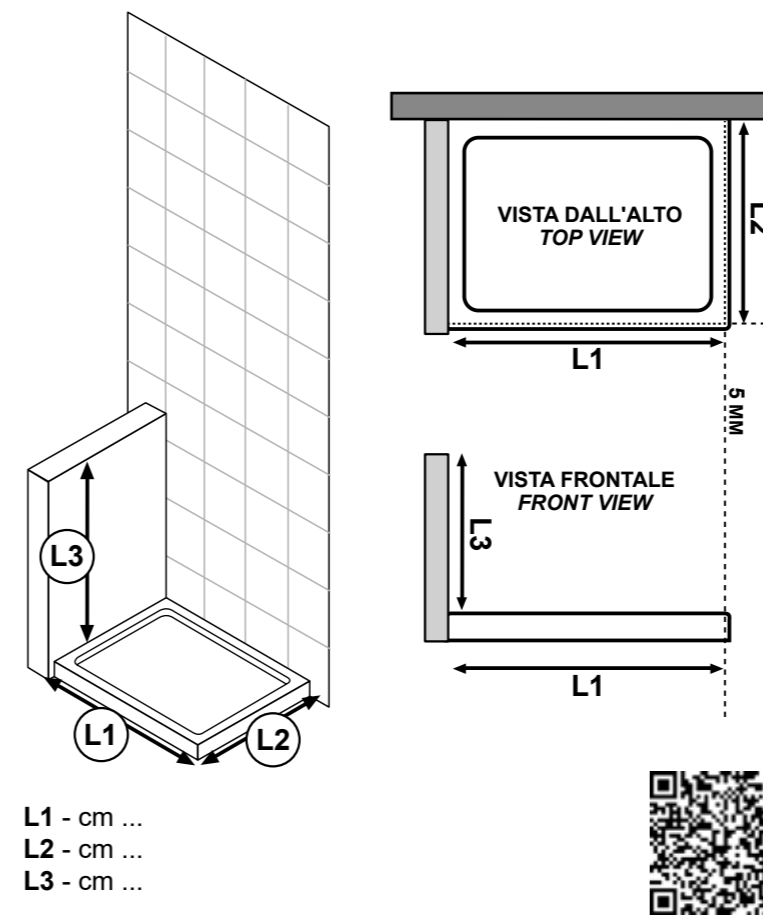

"M" - Spazio in angolo con muretto Dx
 Corner shower enclosure with low wall to the right.
 Eck-Duschkabine mit niedriger Mauer rechts.
 Cabine de douche en angle avec muret bas à droite.

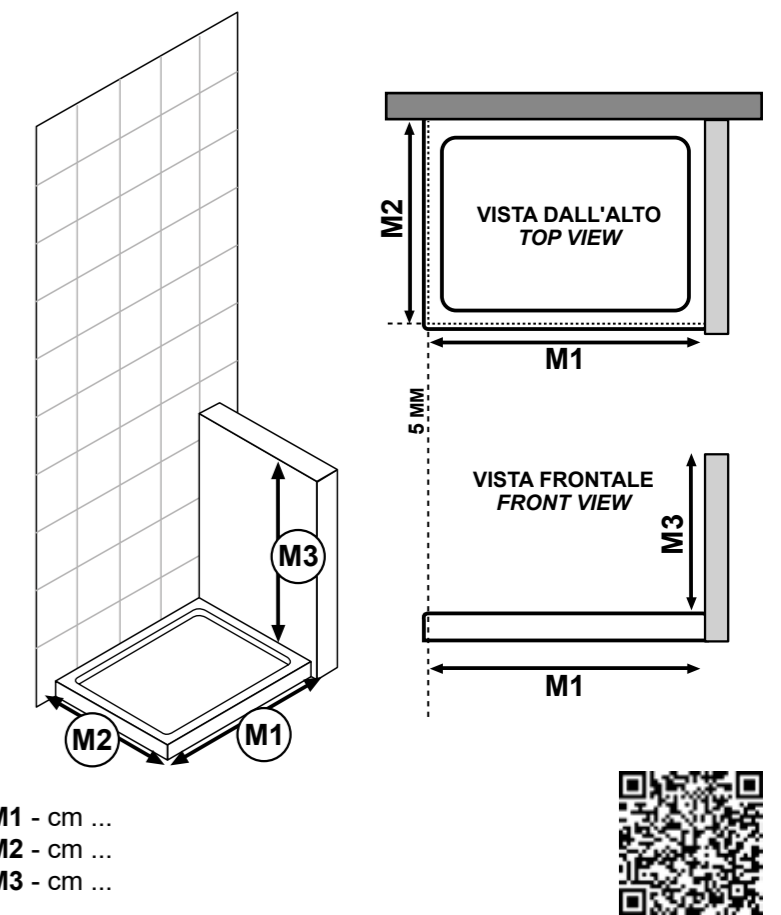

"G" - Spazio in nicchia con muretto Sx
 Wall-to-wall with low wall to the left.
 Nische mit niedriger Mauer links.
 Niche avec muret bas à gauche.

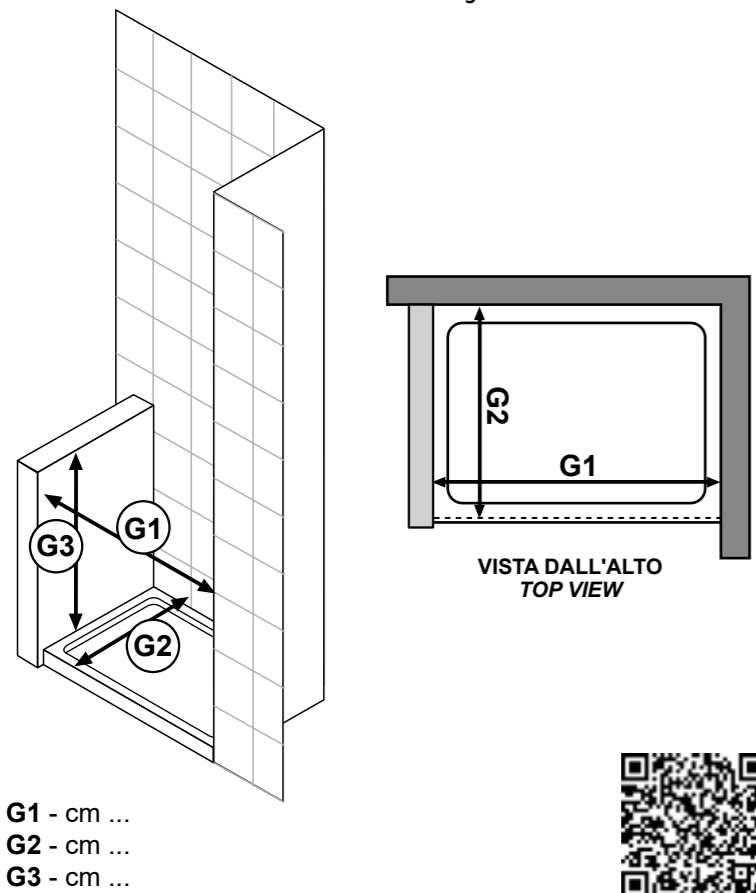

"H" - Spazio in nicchia con muretto Dx
 Wall-to-wall with low wall to the right.
 Nische mit niedriger Mauer rechts.
 Niche avec muret bas à droite.

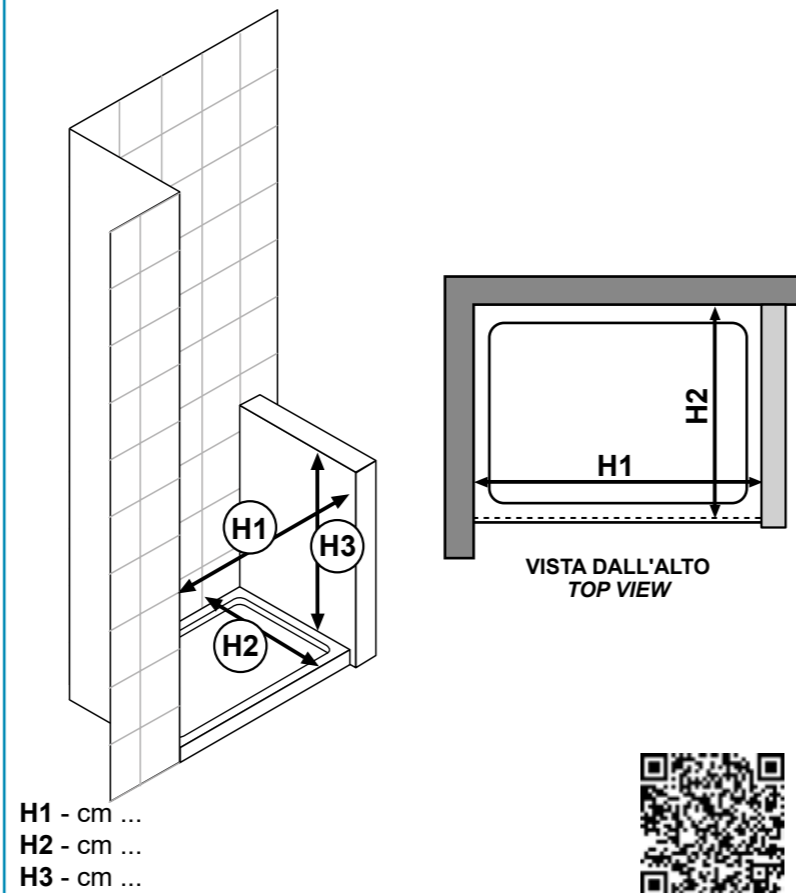

SOLUZIONI DIVERSE

- Contattare UFFICIO COMMERCIALE per avere indicazioni di fattibilità e prezzi.

- For information on feasibility and prices of other solutions, please get in touch with our technical dept.

- Um Angaben zur Durchführbarkeit und Preisen setzen Sie sich bitte mit unserer technische Abteilung in Verbindung.

- Pour des indications de faisabilité et de prix, contacter le bureau technique.

- Modulo di richiesta disponibile online sul sito www.lacus.it - In caso di annullamento dopo l'accettazione, sarà addebitato il costo totale dell'ordine.

- Request form available online at www.lacus.it. In case of cancellation after acceptance, the total amount of the order will be charged.

- Antragsformular online unter www.lacus.it - Bei einer Stornierung nach der Bestellungsannahme wird der gesamte Auftragsbetrag belastet.

- Le formulaire est disponible online sur le site www.lacus.it - En cas d'annulation après accord, le montant total de la commande sera facturé.



TRATTAMENTO ANTICALCARE

Descaling
Entkalkungsbehandlung
Traitement anticalcaire

GIANNUTRI BT

CRISTALLO TRASPARENTE
TRANSPARENT CRYSTAL
TRANSPARENTES KRISTALLGLAS
VERRE TRANSPARENT

8 mm
BATTENTE PIVOT

| CODICE <small>Code - Artikel - Article</small> | Formato (cm) <small>Size - Format - Dimension</small> | Estensibilità <small>Extensibility - Streckbarkeit - Extensibilité</small> | Prezzo (€) <small>Price - Preis - Prix</small> | Lato porta <small>Door - Tür - Porte</small> |  | Ingombro porta <small>Door space Tür-Raumbedarf - Passage</small> |
|---|--|---|---|---|---|--|
| LKBAG 70BT | 70 | 68 ÷ 69 | 1.009,00 | • | 41,0 | 41,5 |
| LKBAG 80BT | 80 | 78 ÷ 79 | 1.049,00 | • | 41,0 | 41,5 |
| LKBAG 90BT | 90 | 88 ÷ 89 | 1.109,00 | • | 51,0 | 51,5 |
| LKBAG 100BT | 100 | 98 ÷ 99 | 1.164,00 | • | 51,0 | 51,5 |
| LKBAG 120BT | 120 | 118 ÷ 119 | 1.236,00 | • | 61,0 | 61,5 |
| LKBAG 140BT | 140 | 138 ÷ 139 | 1.313,00 | • | 61,0 | 61,5 |

***Prezzo: ATTENZIONE il prezzo è relativo ad un singolo lato.**
*Price: NOTICE: Price is for 1 side only.
*Preis: VORSICHT: Der Preis ist für eine einzelne Seite.
*Prix: ATTENTION: le prix est pour un seul côté.

PROFILO MAGGIORE ESTENSIBILITÀ

Wall profile adjustment - Verlängerungsprofil - Profilé pour extension supplémentaire

| Codice - Code Artikel - Article | Formato (cm) - Size Format - Dimension | + cm. | Prezzo (€) - Price Preis - Prix |
|------------------------------------|---|-------|------------------------------------|
| MTP 18B | 3,8 x 200 | 1,0 | 50,00 |

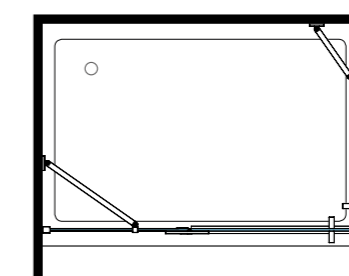
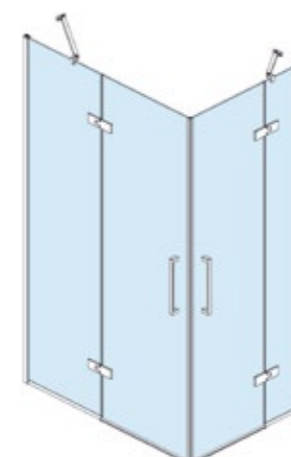
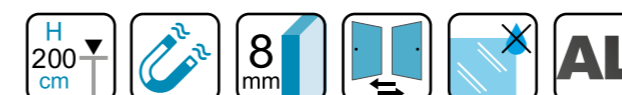

PROFILO A MURO WALL PROFILE - WANDPROFIL - PROFIL DE MUR

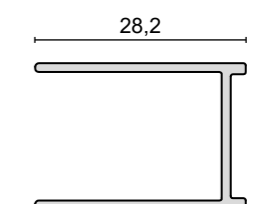

TRATTAMENTO
ANTICALCARE

Descaling
Entkalkungsbehandlung
Traitement anticalcaire

GIANNUTRI

CRISTALLO TRASPARENTE
TRANSPARENT CRYSTAL
TRANSPARENTES KRISTALLGLAS
VERRE TRANSPARENT

8
mm

BATTENTE
PIVOT

| CODICE <i>Code - Artikel - Article</i> | Formato (cm) <i>Size - Format - Dimension</i> | Estensibilità <i>Extensibility - Streckbarkeit - Extensibilität</i> | Prezzo (€) <i>Price - Preis - Prix</i> | Lato porta <i>Door - Tür - Porte</i> |  | Ingombro porta <i>Door space Tür-Raumbedarf - Passage</i> |
|---|--|--|---|---|---|--|
| LKBAG 70 | 70 | 68 ÷ 69 | 1.040,00 | • | 41,0 | 41,5 |
| LKBAG 80 | 80 | 78 ÷ 79 | 1.050,00 | • | 41,0 | 41,5 |
| LKBAG 90 | 90 | 88 ÷ 89 | 1.060,00 | • | 51,0 | 51,5 |
| LKBAG 100 | 100 | 98 ÷ 99 | 1.120,00 | • | 51,0 | 51,5 |
| LKBAG 120 | 120 | 118 ÷ 119 | 1.160,00 | • | 61,0 | 61,5 |
| LKBAG 140 | 140 | 138 ÷ 139 | 1.220,00 | • | 61,0 | 61,5 |

*Prezzo: ATTENZIONE il prezzo è relativo ad un singolo lato.

*Price: NOTICE: Price is for 1 side only.

*Preis: VORSICHT: Der Preis ist für eine einzelne Seite.

*Prix: ATTENTION: le prix est pour un seul côté.

PROFILO MAGGIORE ESTENSIBILITÀ

Wall profile adjustment - Verlängerungsprofil - Profilé pour extension supplémentaire

| Codice - Code Artikel - Article | Formato (cm) - Size Format - Dimension | + cm. | Prezzo (€) - Price Preis - Prix |
|------------------------------------|---|-------|------------------------------------|
| MTP 18 | 3,8 x 200 | 1,0 | 50,00 |

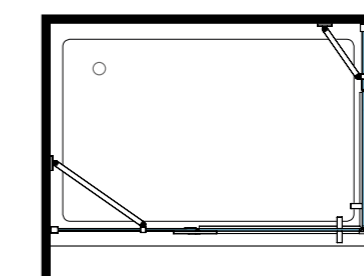
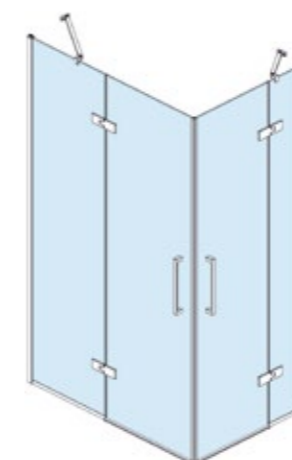

PROFILO A MURO
WALL PROFILE - WANDPROFIL - PROFIL DE MUR

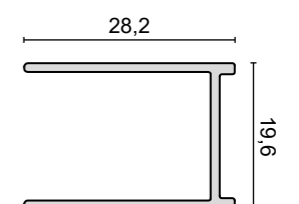

TRATTAMENTO ANTICALCARE

Descaling
Entkalkungsbehandlung
Traitement anticalcaire



ELBA

CRISTALLO TRASPARENTE
TRANSPARENT CRYSTAL
TRANSPARENTES KRISTALLGLAS
VERRE TRANSPARENT

8 mm
BATTENTE
PIVOT

| CODICE <i>Code - Artikel - Article</i> | Formato (cm) <i>Size - Format - Dimension</i> | Estensibilità <i>Extensibility - Streckbarkeit - Extensibilité</i> | Prezzo (€) <i>Price - Preis - Prix</i> | Lato porta <i>Door - Tür - Porte</i> |  Ingombro porta <i>Door space Tür-Raumbedarf - Passage</i> |
|---|--|---|---|---|--|
| LKBAN 90 | 90 | 88,7 ÷ 89,7 | 1.170,00 | • | 51,0 51,5 |
| LKBAN 100 | 100 | 98,7 ÷ 99,7 | 1.220,00 | • | 51,0 51,5 |
| LKBAN 120 | 120 | 118,7 ÷ 119,7 | 1.270,00 | • | 61,0 61,5 |
| LKBAN 140 | 140 | 138,7 ÷ 139,7 | 1.330,00 | • | 61,0 61,5 |

PROFILO MAGGIORE ESTENSIBILITÀ

Wall profile adjustment - Verlängerungsprofil - Profilé pour extension supplémentaire

| Codice - Code Artikel - Article | Formato (cm) - Size Format - Dimension | + cm. | Prezzo (€) - Price Preis - Prix |
|------------------------------------|---|-------|------------------------------------|
| MTP 18 | 3,8 x 200 | 1,0 | 50,00 |

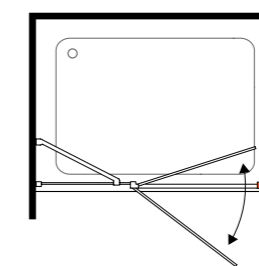

PROFILO A MURO
WALL PROFILE - WANDPROFIL - PROFIL DE MUR

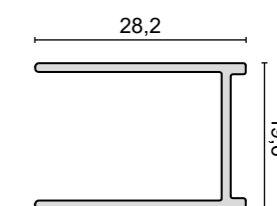

ELBA

CRISTALLO TRASPARENTE
TRANSPARENT CRYSTAL
TRANSPARENTES KRISTALLGLAS
VERRE TRANSPARENT

**TRATTAMENTO
ANTICALCARE**
Descaling
Entkalkungsbehandlung
Traitement anticalcaire

| CODICE Code - Artikel - Article | Formato (cm) Size - Format - Dimension | Estensibilità Extensibility - Streckbarkeit - Extensibilité | Prezzo (€) Price - Preis - Prix | Lato porta Door - Tür - Porte | E cm | Ingombro porta Door space Tür-Raumbedarf - Passage |
|---|--|---|---|---|----------------|---|
| LKBA 90 | 90 | 88 ÷ 89 | 1.060,00 | • | 51,0 | 51,5 |
| LKBA 100 | 100 | 98 ÷ 99 | 1.120,00 | • | 51,0 | 51,5 |
| LKBA 120 | 120 | 118 ÷ 119 | 1.160,00 | • | 61,0 | 61,5 |
| LKBA 140 | 140 | 138 ÷ 139 | 1.220,00 | • | 61,0 | 61,5 |

Parete fissa - Pezzi da ordinare
Side - Necessary pieces
Seite - Notwendige Stücke
Paroi fixe - Paroi à commander

| | | | | |
|-----------------|----|---------|--------|----------|
| LKBAF 70 | 70 | 68 ÷ 69 | 349,00 | 1 |
| LKBAF 80 | 80 | 78 ÷ 79 | 390,00 | 1 |
| LKBAF 90 | 90 | 88 ÷ 89 | 415,00 | 1 |

PROFILO MAGGIORE ESTENSIBILITÀ

Wall profile adjustment - Verlängerungsprofil - Profilé pour extension supplémentaire

| Codice - Code Artikel - Article | Formato (cm) - Size Format - Dimension | + cm. | Prezzo (€) - Price Preis - Prix |
|---|--|--------------|---|
| MTP 18 | 3,8 x 200 | 1,0 | 50,00 |

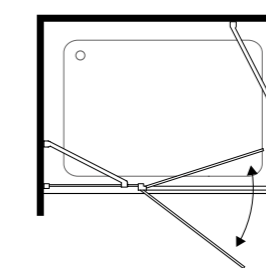
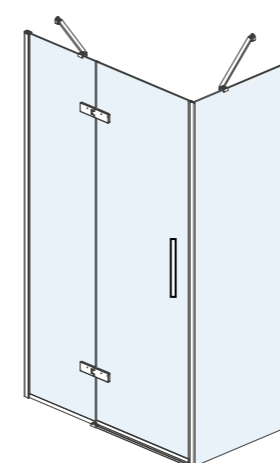
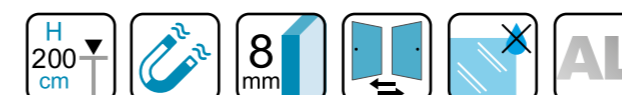

PROFILO A MURO WALL PROFILE - WANDPROFIL - PROFIL DE MUR

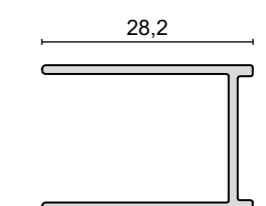

TRATTAMENTO ANTICALCARE

Descaling
Entkalkungsbehandlung
Traitement anticalcaire



ELBA BT

CRISTALLO TRASPARENTE
TRANSPARENT CRYSTAL
TRANSPARENTES KRISTALLGLAS
VERRE TRANSPARENT

8 mm
BATTENTE
PIVOT

| CODICE <small>Code - Artikel - Article</small> | Formato (cm) <small>Size - Format - Dimension</small> | Estensibilità <small>Extensibility - Streckbarkeit - Extensibilité</small> | Prezzo (€) <small>Price - Preis - Prix</small> | Lato porta <small>Door - Tür - Porte</small> | E <small>cm</small> | Ingombro porta <small>Door space Tür-Raumbedarf - Passage</small> |
|--|---|--|--|--|-------------------------------|---|
| LKBAN 90BT | 90 | 88,7 ÷ 89,7 | 1.170,00 | ● | 51,0 | 51,5 |
| LKBAN 100BT | 100 | 98,7 ÷ 99,7 | 1.255,00 | ● | 51,0 | 51,5 |
| LKBAN 120BT | 120 | 118,7 ÷ 119,7 | 1.305,00 | ● | 61,0 | 61,5 |
| LKBAN 140BT | 140 | 138,7 ÷ 139,7 | 1.381,00 | ● | 61,0 | 61,5 |

PROFILO MAGGIORE ESTENSIBILITÀ

Wall profile adjustment - Verlängerungsprofil - Profilé pour extension supplémentaire

| Codice - Code <small>Artikel - Article</small> | Formato (cm) - Size <small>Format - Dimension</small> | + cm. | Prezzo (€) - Price <small>Preis - Prix</small> |
|--|---|--------------|--|
| MTP 18B | 3,8 x 200 | 1,0 | 50,00 |

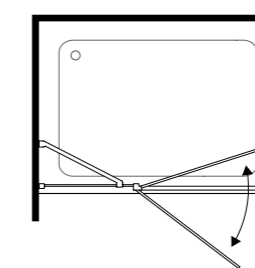
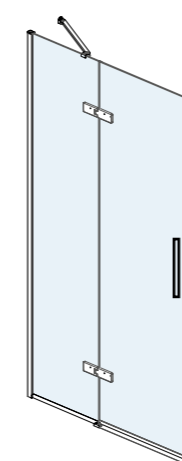

PROFILO A MURO WALL PROFILE - WANDPROFIL - PROFIL DE MUR

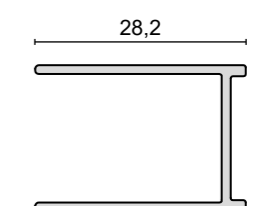

TRATTAMENTO ANTICALCARE

Descaling
Entkalkungsbehandlung
Traitement anticalcaire

ELBA BT

CRISTALLO TRASPARENTE
TRANSPARENT CRYSTAL
TRANSPARENTES KRISTALLGLAS
VERRE TRANSPARENT

8 mm
BATTENTE PIVOT



| CODICE <i>Code - Artikel - Article</i> | Formato (cm) <i>Size - Format - Dimension</i> | Estensibilità <i>Extensibility - Streckbarkeit - Extensibilité</i> | Prezzo (€) <i>Price - Preis - Prix</i> | Lato porta <i>Door - Tür - Porte</i> | E <i>cm</i> | Ingombro porta <i>Door space</i> <i>Tür-Raumbedarf - Passage</i> |
|--|---|--|--|--|-----------------------|---|
| LKBA 90BT | 90 | 88 ÷ 89 | 1.045,00 | • | 51,0 | 51,5 |
| LKBA 100BT | 100 | 98 ÷ 99 | 1.164,00 | • | 51,0 | 51,5 |
| LKBA 120BT | 120 | 118 ÷ 119 | 1.236,00 | • | 61,0 | 61,5 |
| LKBA 140BT | 140 | 138 ÷ 139 | 1.313,00 | • | 61,0 | 61,5 |

Parete fissa - Pezzi da ordinare
Side - Necessary pieces
Seite - Notwendige Stücke
Paroi fixe - Paroi à commander

| | | | | |
|------------|----|---------|--------|---|
| LKBAF 70BT | 70 | 68 ÷ 69 | 401,00 | 1 |
| LKBAF 80BT | 80 | 78 ÷ 79 | 411,00 | 1 |
| LKBAF 90BT | 90 | 88 ÷ 89 | 445,00 | 1 |

PROFILO MAGGIORE ESTENSIBILITÀ

Wall profile adjustment - Verlängerungsprofil - Profilé pour extension supplémentaire

| Codice - Code <i>Artikel - Article</i> | Formato (cm) - Size <i>Format - Dimension</i> | + cm. | Prezzo (€) - Price <i>Preis - Prix</i> |
|--|---|--------------|--|
| MTP 18B | 3,8 x 200 | 1,0 | 50,00 |

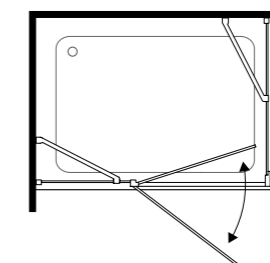
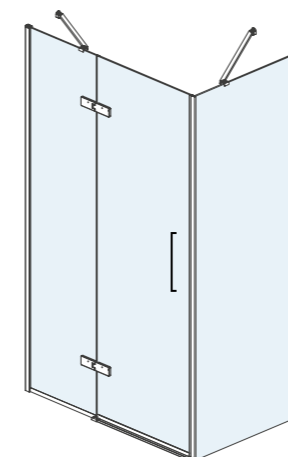

PROFILO A MURO
WALL PROFILE - WANDPROFIL - PROFIL DE MUR

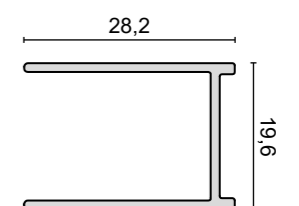

LACUS RIVESTE... SU MISURA - LACUS MAKES IT... TO MEASURE - LACUS FERTIG ...MASSGERECHT - LACUS UNE FABRICATION SUR ...MESURE
 Articoli speciali su ordinazione - Special Items on request - Sonderanfertigungen auf Bestellung - Articles 'à la carte' sur commande

| | | |
|---|---|--|
| | LATO PORTA DOOR - TÜR - PORTE | VETRO SOPRA MURETTO - GLASS ON THE WALL GLAS AN DER WAND - PAROI SUR MURET |
| Altezza max 200 cm. - Larghezza max 125 cm. Height max 200 cm. - Width max 125 cm. Maximale Höhe 200 cm. - Maximale Breite 125 cm. Hauteur 200 cm. maximum - Largeur 125 cm. maximum | Altezza max 200 cm. - Larghezza max 150 cm. Height max 200 cm. - Width max 150 cm. Maximale Höhe 200 cm. - Maximale Breite 150 cm. Hauteur 200 cm. maximum - Largeur 150 cm. maximum | NON DISPONIBILE UNAVAILABLE NICHT VERFÜGBAR PAS DISPONIBLE |



| | | |
|---|--|--|
| PREZZO DI LISTINO AL PEZZO (TRASPARENTE) GROSS PREIS PRO PIECE (TRANSPARENT) LISTENPREIS PRO STÜCK (TRANSPARENT) PRIX TARIF PAR PIÈCE (TRANSPARENT) | PREVENTIVO SU RICHIESTA PRICE ON REQUEST ANGEBOT AUF ANFRAGE DEVIS SUR DEMANDE | PREVENTIVO SU RICHIESTA PRICE ON REQUEST ANGEBOT AUF ANFRAGE DEVIS SUR DEMANDE |
|---|--|--|

| | | | |
|------------------|--|--|--|
| GIANNUTRI | NON DISPONIBILE UNAVAILABLE NICHT VERFÜGBAR PAS DISPONIBLE | | NON DISPONIBILE UNAVAILABLE NICHT VERFÜGBAR PAS DISPONIBLE |
|------------------|--|--|--|

| | | | | | |
|-------------|---|---|----------|--|--|
| ELBA | | FASCIA 1: da 0,01 a 0,50 mq Level 1: from 0.01 to 0.5 sqm | € 550,00 | | |
| | FASCIA 2: da 0,51 a 1,00 mq Level 2: from 0.51 to 1.0 sqm | € 652,00 | | | |
| | FASCIA 3: da 1,01 a 1,50 mq Level 3: from 1.01 to 1.5 sqm | € 771,00 | | | |
| | FASCIA 4: da 1,51 a 2,00 mq Level 4: from 1.51 to 2.0 sqm | € 877,00 | | | |
| | FASCIA 5: da 2,01 a 2,50 mq Level 5: from 2.01 to 2.5 sqm | € 982,00 | | | |

Maggiorazione per vetro Matt e Gray: +15%
 Surcharge for matt and grey crystal + 15%
 Aufpreis für Matt und Grey Kristallglas +15%
 Majoration pour les verres Mat et Grey: +15%

ATTENZIONE:
CALCOLARE I MQ. DEL PEZZO PER STABILIRE LA FASCIA DI APPARTENENZA
 Per soluzioni diverse da quelle contemplate contattare ns. ufficio tecnico per avere indicazioni di fattibilità e prezzi.

ATTENTION:
CALCULATE THE SQM OF THE ARTIKEL TO ESTABLISH THE BELONGING LEVEL.
 For information on feasibility and prices of other solutions, please get in touch with our technical dept.

ATTENTION:
CALCULER LES M². DE LA PAROI POUR ÉTABLIR LA TRANCHÉE D'APPARTENANCE
 Pour d'autres solutions que celles envisagées, contactez notre bureau technique pour connaître la faisabilité et les tarifs.

VORSICHT:
BERECHNEN DIE QM. DES STÜCKES, ZUR ERFÜLLUNG DER ZUGEHÖRIGEN BAND
 Für andere als die in Betracht gezogenen Lösungen wenden Sie sich an unser technisches Büro, um Informationen zu Machbarkeit und Preisen zu erhalten.



MANIGLIA
HANDLE - GRIFF - POIGNÉE



BRACCIO
BAR - ARM - BARRE DEL RENFORT



BRACCIO SNODABILE BLACK
BLACK ADJUSTABLE ARM
SCHWARZER VERSTELLBARER ARM
BARRE DE RENFORT ARTICULÉE NOIR SATINÉ



CERNIERA
HINGE - SCHARNIER - CHARNIÈRE

CARATTERISTICHE GENERALI

- Cristallo temperato da 8 mm.
- Finitura trasparente.
- Profilo in alluminio cromo lucido e nero satinato.
- Chiusura magnetica delle ante.
- Chiusura ad anta battente.
- Estensione da 1 cm.
- Maniglie e cerniere zama.
- Trattamento anticalcare.

GENERAL FEATURES

- 8 mm tempered safety crystal.
- Transparent.
- Polished or black satin aluminium profile.
- Magnetic waterproof closure.
- Outwards/inwards opening version.
- Extension 1 cm.
- Handles and Hinge made of zinc alloy.
- Descaling.

ALLGEMEINE SPEZIFIKATIONEN

- Sekurirkristallglas 8 mm stark.
- Kristallglasfinish: Transparent.
- Poliertes Chrom- oder Schwarz-satiniertes Profil.
- Wasserdichtes Magnetverschluss der Türen.
- Drehtüren.
- Streckbarkeit 1 cm.
- Griff und Scharnier aus Zamak.
- Entkalkungsbehandlung.

SPECIFICATIONS GENERALES

- Verre trempé 8 mm.
- Finition du verre: transparent.
- Profilé en aluminium chromé et noir satiné.
- Portes à fermeture magnétique.
- Ouverture pivotante.
- Extensibilité de 1 cm.
- Poignées et charnières en zamak.
- Traitement anticalcare.



TRATTAMENTO ANTICALCARE

Descaling
Entkalkungsbehandlung
Traitement anticalcaire

S.PIETRO GOLD

8 mm
BATTENTE PIVOT

| CODICE <i>Code - Artikel - Article</i> | Formato (cm) <i>Size - Format - Dimension</i> | Estensibilità <i>Extensibility - Streckbarkeit - Extensibilité</i> | Prezzo (€) <i>Price - Preis - Prix</i> | Lato porta <i>Door - Tür - Porte</i> | E <i>cm</i> | Ingombro porta <i>Door space</i> <i>Tür-Raumbedarf - Passage</i> |
|--|---|--|--|--|-----------------------|---|
| LAB 9028G | 90 | 88,5 ÷ 90,5 | 763,00 | • | 59,7 | 60,5 |
| LAB 10028G | 100 | 98,5 ÷ 100,5 | 820,00 | • | 59,7 | 60,5 |
| LAB 12028G | 120 | 118,5 ÷ 120,5 | 910,00 | • | 59,7 | 60,5 |
| LAB 14028G | 140 | 138,5 ÷ 140,5 | 998,00 | • | 59,7 | 60,5 |

PROFILO MAGGIORE ESTENSIBILITÀ

Wall profile adjustment - Verlängerungsprofil - Profilé pour extension supplémentaire

| Codice - Code <i>Artikel - Article</i> | Formato (cm) - Size <i>Format - Dimension</i> | + cm. | Prezzo (€) - Price <i>Preis - Prix</i> |
|--|---|--------------|--|
| MTP 35G | 3,6 x 200 | 1,5 | 64,00 |

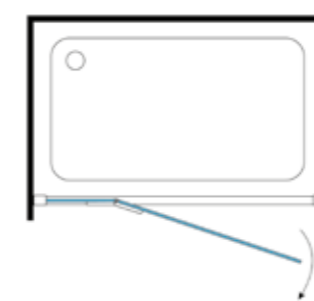
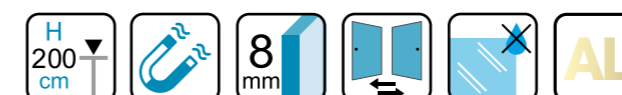

PROFILO A MURO LATO ANTA FISSA
WALL PROFILE FOR SIDE PANEL
WANDPROFIL FÜR SEITE
PROFIL DE MUR LATERAL FIXE

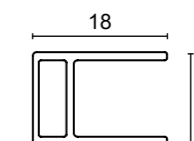

PROFILO A MURO LATO CHIUSURA
WALL PROFILE FOR DOOR
WANDPROFIL FÜR TÜRSEITE
PROFIL DE MUR COTE PORTE

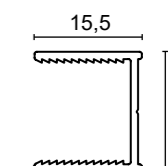

TRATTAMENTO ANTICALCARE

Descaling
Entkalkungsbehandlung
Traitement anticalcaire



S.PIETRO GOLD

8 mm
BATTENTE PIVOT

| CODICE <small>Code - Artikel - Article</small> | Formato (cm) <small>Size - Format - Dimension</small> | Estensibilità <small>Extensibility - Streckbarkeit - Extensibilité</small> | Prezzo (€) <small>Price - Preis - Prix</small> | Lato porta <small>Door - Tür - Porte</small> |  | Ingombro porta <small>Door space Tür-Raumbedarf - Passage</small> |
|---|--|---|---|---|---|--|
| LAB 9028G | 90 | 87,7 ÷ 88,7 | 763,00 | • | 59,3 | 60,5 |
| LAB 10028G | 100 | 97,7 ÷ 98,7 | 820,00 | • | 59,3 | 60,5 |
| LAB 12028G | 120 | 117,7 ÷ 118,7 | 910,00 | • | 59,3 | 60,5 |
| LAB 14028G | 140 | 137,7 ÷ 138,7 | 998,00 | • | 59,3 | 60,5 |

Parete fissa - Pezzi da ordinare
Side - Necessary pieces
Seite - Notwendige Stücke
Paroi fixe - Paroi à commander

| | | | | |
|------------|----|---------|--------|---|
| LABF 7018G | 70 | 68 ÷ 69 | 420,00 | 1 |
| LABF 8018G | 80 | 78 ÷ 79 | 468,00 | 1 |
| LABF 9018G | 90 | 88 ÷ 89 | 505,00 | 1 |

PROFILO MAGGIORE ESTENSIBILITÀ

Wall profile adjustment - Verlängerungsprofil - Profilé pour extension supplémentaire

| Codice - Code Artikel - Article | Formato (cm) - Size Format - Dimension | + cm. | Prezzo (€) - Price Preis - Prix |
|------------------------------------|---|-------|------------------------------------|
| MTP 35G | 3,6 x 200 | 1,5 | 64,00 |

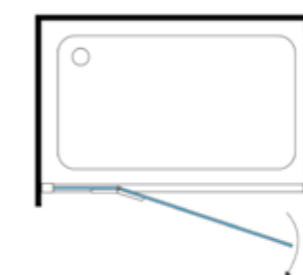
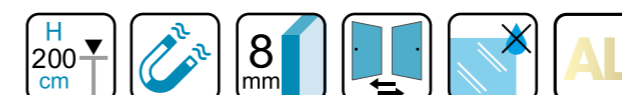

PROFILO A MURO
WALL PROFILE - WANDPROFIL - PROFIL DE MUR

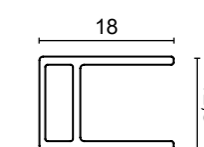

TRATTAMENTO ANTICALCARE

Descaling
Entkalkungsbehandlung
Traitement anticalcaire

S.PIETRO

8 mm

BATTENTE PIVOT

| CODICE <i>Code - Artikel - Article</i> | Formato (cm) <i>Size - Format - Dimension</i> | Estensibilità <i>Extensibility - Streckbarkeit - Extensibilité</i> | Prezzo (€) <i>Price - Preis - Prix</i> | Lato porta <i>Door - Tür - Porte</i> | E <i>cm</i> | Ingombro porta <i>Door space</i> <i>Tür-Raumbedarf - Passage</i> |
|--|---|--|--|--|-----------------------|---|
| LAB 9028 | 90 | 88,5 ÷ 90,5 | 752,00 | • | 59,7 | 60,5 |
| LAB 10028 | 100 | 98,5 ÷ 100,5 | 808,00 | • | 59,7 | 60,5 |
| LAB 12028 | 120 | 118,5 ÷ 120,5 | 897,00 | • | 59,7 | 60,5 |
| LAB 14028 | 140 | 138,5 ÷ 140,5 | 984,00 | • | 59,7 | 60,5 |

PROFILO MAGGIORE ESTENSIBILITÀ

Wall profile adjustment - Verlängerungsprofil - Profilé pour extension supplémentaire

| Codice - Code <i>Artikel - Article</i> | Formato (cm) - Size <i>Format - Dimension</i> | + cm. | Prezzo (€) - Price <i>Preis - Prix</i> |
|--|---|--------------|--|
| MTP 35 | 3,6 x 200 | 1,5 | 55,00 |

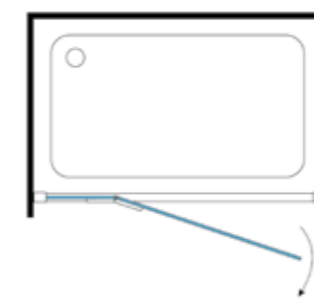

PROFILO A MURO LATO ANTA FISSA
WALL PROFILE FOR SIDE PANEL
WANDPROFIL FÜR SEITEWAND
PROFIL DE MUR LATERAL FIXE

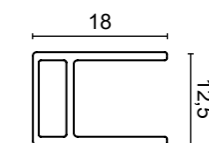

PROFILO A MURO LATO CHIUSURA
WALL PROFILE FOR DOOR
WANDPROFIL FÜR TURSEITE
PROFIL DE MUR COTE PORTE

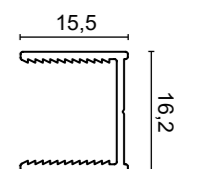

TRATTAMENTO ANTICALCARE

Descaling
Entkalkungsbehandlung
Traitement anticalcaire



S.PIETRO

8
mm
BATTENTE
PIVOT

| CODICE <i>Code - Artikel - Article</i> | Formato (cm) <i>Size - Format - Dimension</i> | Estensibilità <i>Extensibility - Streckbarkeit - Extensibilité</i> | Prezzo (€) <i>Price - Preis - Prix</i> | Lato porta <i>Door - Tür - Porte</i> | E <i>cm</i> | Ingombro porta <i>Door space</i> <i>Tür-Raumbedarf - Passage</i> |
|--|---|--|--|--|-----------------------|---|
| LAB 9028 | 90 | 87,7 ÷ 88,7 | 752,00 | • | 59,3 | 60,5 |
| LAB 10028 | 100 | 97,7 ÷ 98,7 | 808,00 | • | 59,3 | 60,5 |
| LAB 12028 | 120 | 117,7 ÷ 118,7 | 897,00 | • | 59,3 | 60,5 |
| LAB 14028 | 140 | 137,7 ÷ 138,7 | 984,00 | • | 59,3 | 60,5 |

Parete fissa - Pezzi da ordinare
Side - Necessary pieces
Seite - Notwendige Stücke
Paroi fixe - Paroi à commander

| | | | | |
|-----------|----|---------|--------|---|
| LABF 7018 | 70 | 68 ÷ 69 | 415,00 | 1 |
| LABF 8018 | 80 | 78 ÷ 79 | 463,00 | 1 |
| LABF 9018 | 90 | 88 ÷ 89 | 499,00 | 1 |

PROFILO MAGGIORE ESTENSIBILITÀ

Wall profile adjustment - Verlängerungsprofil - Profilé pour extension supplémentaire

| Codice - Code <i>Artikel - Article</i> | Formato (cm) - Size <i>Format - Dimension</i> | + cm. | Prezzo (€) - Price <i>Preis - Prix</i> |
|--|---|--------------|--|
| MTP 35 | 3,6 x 200 | 1,5 | 55,00 |

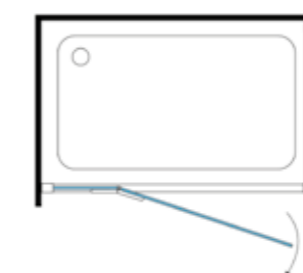

PROFILO A MURO
WALL PROFILE - WANDPROFIL - PROFIL DE MUR

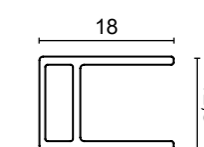

LACUS RIVESTE... SU MISURA - LACUS MAKES IT... TO MEASURE - LACUS FERTIG ...MASSGERECHT - LACUS UNE FABRICATION SUR ...MESURE

Articoli speciali su ordinazione - Special Items on request - Sonderanfertigungen auf Bestellung - Articles 'à la carte' sur commande

| | | |
|---|---|--|
| <p>LATO FISSO - FIXED PANEL FESTE SEITENWAND - PANNEAU FIXE</p> | <p>LATO PORTA DOOR - TÜR - PORTE</p> | <p>VETRO SOPRA MURETTO - GLASS ON THE WALL GLAS AN DER WAND - PAROI SUR MURET</p> |
| <p>Altezza max 200 cm. - Larghezza max 125 cm. Height max 200 cm. - Width max 125 cm. Maximale Höhe 200 cm. - Maximale Breite 125 cm. Hauteur 200 cm. maximum - Largeur 125 cm. maximum</p> | | |



NON DISPONIBILE
UNAVAILABLE
NICHT VERFÜGBAR
PAS DISPONIBLE

| | | |
|---|--|--|
| <p>PREZZO DI LISTINO AL PEZZO (TRASPARENTE) GROSS PREIS PRO PIECE (TRANSPARENT) LISTENPREIS PRO STÜCK (TRANSPARENT) PRIX TARIF PAR PIÈCE (TRANSPARENT)</p> | <p>PREVENTIVO SU RICHIESTA PRICE ON REQUEST ANGEBOT AUF ANFRAGE DEVIS SUR DEMANDE</p> | <p>NON DISPONIBILE UNAVAILABLE NICHT VERFÜGBAR PAS DISPONIBLE</p> |
|---|--|--|

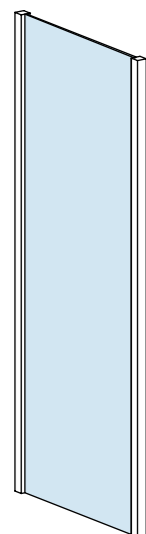

| | |
|---|-----------------|
| <p>FASCIA 1: da 0,01 a 0,50 mq Level 1: from 0.01 to 0.5 sqm</p> | <p>€ 550,00</p> |
| <p>FASCIA 2: da 0,51 a 1,00 mq Level 2: from 0.51 to 1.0 sqm</p> | <p>€ 646,00</p> |
| <p>FASCIA 3: da 1,01 a 1,50 mq Level 3: from 1.01 to 1.5 sqm</p> | <p>€ 763,00</p> |
| <p>FASCIA 4: da 1,51 a 2,00 mq Level 4: from 1.51 to 2.0 sqm</p> | <p>€ 864,00</p> |
| <p>FASCIA 5: da 2,01 a 2,50 mq Level 5: from 2.01 to 2.5 sqm</p> | <p>€ 964,00</p> |

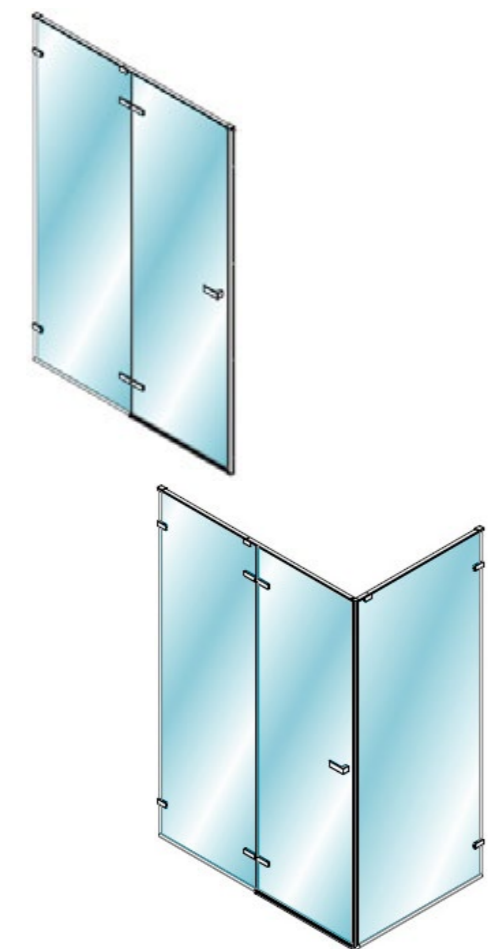

NON DISPONIBILE
UNAVAILABLE
NICHT VERFÜGBAR
PAS DISPONIBLE

Maggiorazione per vetro Matt e Gray: +15%
Surcharge for matt and grey crystal + 15%
Aufpreis für Matt und Grey Kristallglas +15%
Majoration pour les verres Matt e Grey: +15%

ATTENZIONE:
CALCOLARE I MQ. DEL PEZZO PER STABILIRE LA FASCIA DI APPARTENENZA
Per soluzioni diverse da quelle contemplate contattare ns. ufficio tecnico per avere indicazioni di fattibilità e prezzi.
VORSICHT:
BERECHNEN DIE QM. DES STÜCKES, ZUR ERFÜLLUNG DER ZUGEHÖRIGEN BAND
Für andere als die in Betracht gezogenen Lösungen wenden Sie sich an unser technisches Büro, um Informationen zu Machbarkeit und Preisen zu erhalten.

ATTENTION:
CALCULATE THE SQM OF THE ARTIKEL TO ESTABLISH THE BELONGING LEVEL.
For information on feasibility and prices of other solutions, please get in touch with our technical dept.

ATTENTION:
CALCULER LES M². DE LA PAROI POUR ÉTABLIR LA TRANCHE D'APPARTENANCE
Pour d'autres solutions que celles envisagées, contactez notre bureau technique pour connaître la faisabilité et les tarifs.

DETTAGLI & CARATTERISTICHE



CERNIERE GOLD SPAZZOLATO
BRUSHED GOLD HINGES - GEBÜRSTETER GOLD SCHARNIERE
CHARNIERE OR BROSSE



MANIGLIA GOLD SPAZZOLATO
BRUSHED GOLD HANDLE - GEBURSTETER GOLD GRIFF
POIGNEE OR BROSSE

CARATTERISTICHE GENERALI

- Cristallo temperato da 8 mm.
- Finitura trasparente.
- Profilo in alluminio cromo lucido e oro spazzolato.
- Chiusura magnetica delle ante.
- Chiusura ad anta battente.
- Estensione da 1 cm.
- Maniglie e cerniere in zama.
- Trattamento anticalcare.

GENERAL FEATURES

- 8 mm tempered safety crystal.
- Transparent.
- Polished aluminium and brushed gold profile.
- Magnetic waterproof closure.
- Outwards opening.
- Extension 1 cm.
- Handles and Hinges made of zinc alloy.
- Descaling.

ALLGEMEINE SPEZIFIKATIONEN

- Sekurirkristallglas 8 mm stark.
- Kristallglasfinish: Transparent.
- Poliertes Chrom- und gebürstetes Gold satiniertes Profil.
- Wasserdichtes Magnetverschlus der Türen.
- Drehtür.
- Streckbarkeit 1 cm.
- Griff und Scharnier aus Zamak.
- Entkalkungsbehandlung.

SPECIFICATIONS GENERALES

- Verre trempé 8 mm.
- Finition du verre: transparent.
- Aluminium chromé et or brossé.
- Portes à fermeture magnétique.
- Ouverture pivotante.
- Extensibilité de 1 cm.
- Poignées et charnières en zamak.
- Traitement anticalcare.



TRATTAMENTO ANTICALCARE
 Descaling
 Entkalkungsbehandlung
 Traitement anticalcaire

LAMPEDUSA

CRISTALLO TRASPARENTE
 TRANSPARENT CRYSTAL
 TRANSPARENTES KRISTALLGLAS
 VERRRE TRANSPARENT

8 mm
BATTENTE PIVOT

| CODICE <i>Code - Artikel - Article</i> | Formato (cm) <i>Size - Format - Dimension</i> | Estensibilità <i>Extensibility - Streckbarkeit - Extensibilité</i> | Prezzo (€) <i>Price - Preis - Prix</i> | E <i>cm</i> | Lato porta <i>Door - Tür - Porte</i> | Ingombro porta <i>Door space Tür-Raumbedarf - Passage</i> |
|--|---|--|--|-----------------------|--|---|
| LRB EVO 90 | 90 | 87,5 ÷ 89 | 809,00 | 47,0 | • | 44 |
| LRB EVO 100 | 100 | 97,5 ÷ 99 | 841,00 | 57,0 | • | 54 |
| LRB EVO 120 | 120 | 117,5 ÷ 119 | 911,00 | 57,0 | • | 54 |
| LRB EVO 140 | 140 | 137,5 ÷ 139 | 975,00 | 57,0 | • | 54 |

| | | | Prezzo unitario <i>Price - Preis - Prix</i> | Parete fissa - Pezzi da ordinare <i>Side - Necessary pieces Seite - Notwendige Stücke Paroi fixe - Paroi à commander</i> |
|--------------------|----|-----------|---|--|
| LRBF EVO 70 | 70 | 67,5 ÷ 69 | 355,00 | 1 |
| LRBF EVO 80 | 80 | 77,5 ÷ 79 | 389,00 | 1 |
| LRBF EVO 90 | 90 | 87,5 ÷ 89 | 425,00 | 1 |

PROFILO MAGGIORE ESTENSIBILITÀ

Wall profile adjustment - Verlängerungsprofil - Profilé pour extension supplémentaire

| Codice - Code <i>Artikel - Article</i> | Formato (cm) - Size <i>Format - Dimension</i> | + cm. | Prezzo (€) - Price <i>Preis - Prix</i> |
|--|---|--------------|--|
| MTP 24 | 4,6 x 200 | 1,5 | 102,00 |



PROFILO A MURO WALL PROFILE - WANDPROFIL - PROFIL DE MUR

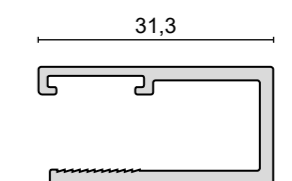

TRATTAMENTO ANTICALCARE

Descaling
Entkalkungsbehandlung
Traitement anticalcaire



LAMPEDUSA

CRISTALLO TRASPARENTE
TRANSPARENT CRYSTAL
TRANSPARENTES KRISTALLGLAS
VERRE TRANSPARENT

8 mm
BATTENTE
PIVOT

| CODICE <i>Code - Artikel - Article</i> | Formato (cm) <i>Size - Format - Dimension</i> | Estensibilità <i>Extensibility - Streckbarkeit - Extensibilité</i> | Prezzo (€) <i>Price - Preis - Prix</i> | E <i>cm</i> | Lato porta <i>Door - Tür - Porte</i> | Ingombro porta <i>Door space Tür-Raumbedarf - Passage</i> |
|--|---|--|--|-----------------------|--|---|
| LRB EVO 90 | 90 | 87,5 ÷ 89 | 809,00 | 47,0 | • | 44 |
| LRB EVO 100 | 100 | 97,5 ÷ 99 | 841,00 | 57,0 | • | 54 |
| LRB EVO 120 | 120 | 117,5 ÷ 119 | 911,00 | 57,0 | • | 54 |
| LRB EVO 140 | 140 | 137,5 ÷ 139 | 975,00 | 57,0 | • | 54 |

| | | | Prezzo unitario <i>Price - Preis - Prix</i> | Parete fissa - Pezzi da ordinare <i>Side - Necessary pieces Seite - Notwendige Stücke Paroi fixe - Paroi à commander</i> |
|--------------------|----|-----------|---|--|
| LRBF EVO 70 | 70 | 67,5 ÷ 69 | 355,00 | 1 |
| LRBF EVO 80 | 80 | 77,5 ÷ 79 | 389,00 | 1 |
| LRBF EVO 90 | 90 | 87,5 ÷ 89 | 425,00 | 1 |

PROFILO MAGGIORE ESTENSIBILITÀ

Wall profile adjustment - Verlängerungsprofil - Profilé pour extension supplémentaire

| Codice - Code <i>Artikel - Article</i> | Formato (cm) - Size <i>Format - Dimension</i> | + cm. | Prezzo (€) - Price <i>Preis - Prix</i> |
|--|---|--------------|--|
| MTP 24 | 4,6 x 200 | 1,5 | 102,00 |

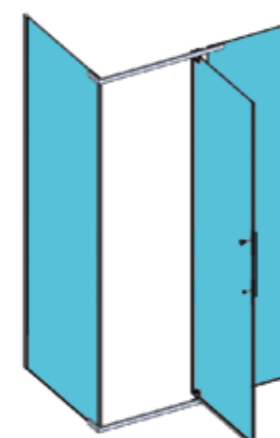

PROFILO A MURO WALL PROFILE - WANDPROFIL - PROFIL DE MUR

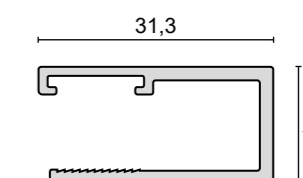

LACUS RIVESTE... SU MISURA - LACUS MAKES IT... TO MEASURE - LACUS FERTIG ...MASSGERECHT - LACUS UNE FABRICATION SUR ...MESURE
Articoli speciali su ordinazione - Special Items on request - Sonderanfertigungen auf Bestellung - Articles 'à la carte' sur commande

| | | |
|---|---|---|
| LATO FISSO - FIXED PANEL FESTE SEITENWAND - PANNEAU FIXE | LATO PORTA DOOR - TÜR - PORTE | VETRO SOPRA MURETTO - GLASS ON THE WALL GLAS AN DER WAND - PAROI SUR MURET |
| Altezza max 200 cm. - Larghezza max 125 cm. Height max 200 cm. - Width max 125 cm. Maximale Höhe 200 cm. - Maximale Breite 125 cm. Hauteur 200 cm. maximum - Largeur 125 cm. maximum | Altezza max 200 cm. - Larghezza max 150 cm. Height max 200 cm. - Width max 150 cm. Maximale Höhe 200 cm. - Maximale Breite 150 cm. Hauteur 200 cm. maximum - Largeur 150 cm. maximum | NON DISPONIBILE NOT AVAILABLE NICHT VERFÜGBAR INDISPONIBLE |
|  |    | |

| | | |
|---|--|--|
| PREZZO DI LISTINO AL PEZZO (TRASPARENTE) GROSS PREIS PRO PIECE (TRANSPARENT) LISTENPREIS PRO STÜCK (TRANSPARENT) PRIX TARIF PAR PIÈCE (TRANSPARENT) | PREVENTIVO SU RICHIESTA PRICE ON REQUEST ANGEBOT AUF ANFRAGE DEVIS SUR DEMANDE | NON DISPONIBILE NOT AVAILABLE NICHT VERFÜGBAR INDISPONIBLE |
|---|--|--|

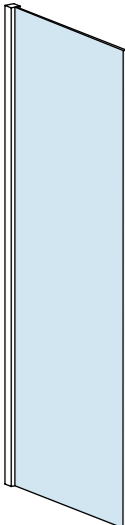
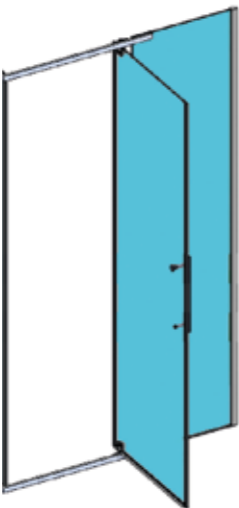
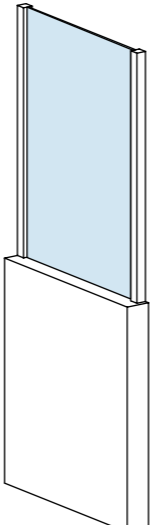
| | | | | |
|--|---|-----------------|--|--|
|  | FASCIA 1: da 0,01 a 0,50 mq Level 1: from 0.01 to 0.5 sqm | €424,00 |  |  |
| | FASCIA 2: da 0,51 a 1,00 mq Level 2: from 0.51 to 1.0 sqm | € 525,00 | | |
| | FASCIA 3: da 1,01 a 1,50 mq Level 3: from 1.01 to 1.5 sqm | € 649,00 | | |
| | FASCIA 4: da 1,51 a 2,00 mq Level 4: from 1.51 to 2.0 sqm | € 751,00 | | |
| | FASCIA 5: da 2,01 a 2,50 mq Level 5: from 2.01 to 2.5 sqm | € 856,00 | | |

Maggiorazione per vetro Matt e Gray: +15%
 Surcharge for matt and grey crystal + 15%
 Aufpreis für Matt und Grey Kristallglas +15%
 Majoration pour les verres Mat et Grey: +15%

| | |
|---|--|
| <p>ATTENZIONE: CALCOLARE I MQ. DEL PEZZO PER STABILIRE LA FASCIA DI APPARTENENZA Per soluzioni diverse da quelle contemplate contattare ns. ufficio tecnico per avere indicazioni di fattibilità e prezzi.</p> <p>VORSICHT: BERECHNEN DIE QM. DES STÜCKES, ZUR ERFÜLLUNG DER ZUGEHÖRIGEN BAND Für andere als die in Betracht gezogenen Lösungen wenden Sie sich an unser technisches Büro, um Informationen zu Machbarkeit und Preisen zu erhalten.</p> | <p>ATTENTION: CALCULATE THE SQM OF THE ARTIKEL TO ESTABLISH THE BELONGING LEVEL. For information on feasibility and prices of other solutions, please get in touch with our technical dept.</p> <p>ATTENTION: CALCULER LES M². DE LA PAROI POUR ÉTABLIR LA TRANCHE D'APPARTENANCE Pour d'autres solutions que celles envisagées, contactez notre bureau technique pour connaître la faisabilité et les tarifs.</p> |
|---|--|



STAFFA A "L"
 L-BRACKET - ECKWINKEL - SUPPORT À "L"



MANIGLIA
 HANDLE - GRIFF - POIGNÉE



CERNIERA
 HINGE - SCHARNIER - CHARNIÈRE

| | | | |
|--|---|--|---|
| <p>CARATTERISTICHE GENERALI</p> <ul style="list-style-type: none"> • Cristallo temperato da 8 mm. • Finitura trasparente. • Profilo in alluminio cromo lucido. • Chiusura magnetica delle ante. • Chiusura ad anta battente. • Estensione da 1,5 cm. • Maniglia in acciaio inox, cerniere in zama. • Trattamento anticalcare. | <p>GENERAL FEATURES</p> <ul style="list-style-type: none"> • 8 mm tempered safety crystal. • Transparent. • Polished aluminium profile. • Magnetic waterproof closure. • Outwards opening. • Extension 1,5 cm. • Handle made of stainless steel and Hinge made of zinc alloy. • Descaling. | <p>ALLGEMEINE SPEZIFIKATIONEN</p> <ul style="list-style-type: none"> • Sekurirkristallglas 8 mm stark. • Kristallglasfinish: Transparent. • Poliertes Chrom- Profil. • Wasserdichtes Magnetverschluss der Türen. • Drehtür. • Streckbarkeit 1,5 cm. • Griff aus rostfreie Stahl und Scharnier aus Zamak. • Entkalkungsbehandlung. | <p>SPECIFICATIONS GENERALES</p> <ul style="list-style-type: none"> • Verre trempé 8 mm. • Finition du verre: transparent. • Profilé en aluminium chromé. • Portes à fermeture magnétique. • Ouverture pivotante. • Extensibilité de 1,5 cm. • Poignée en acier et charnière en zamak. • Traitement anticalcaire. |
|--|---|--|---|

TRATTAMENTO ANTICALCARE

Descaling
Entkalkungsbehandlung
Traitement anticalcaire

CAPRAIA

CRISTALLO TRASPARENTE
TRANSPARENT CRYSTAL
TRANSPARENTES KRISTALLGLAS
VERRE TRANSPARENT

8 mm
BATTENTE PIVOT



| CODICE Code - Artikel - Article | Formato (cm) Size - Format - Dimension | Estensibilità Extensibility - Streckbarkeit - Extensibilité | Prezzo (€) Price - Preis - Prix | Lato porta Door - Tür - Porte | E cm | Ingombro porta Door space Tür-Raumbedarf - Passage |
|---|--|---|---|---|----------------|---|
| LRBA 90 | 90 | 88 ÷ 89 | 845,00 | • | 51,0 | 52,5 |
| LRBA 100 | 100 | 98 ÷ 99 | 883,00 | • | 51,0 | 52,5 |
| LRBA 120 | 120 | 118 ÷ 119 | 945,00 | • | 61,0 | 62,5 |
| LRBA 140 | 140 | 138 ÷ 139 | 1.080,00 | • | 61,0 | 62,5 |

Parete fissa - Pezzi da ordinare
Side - Necessary pieces
Seite - Notwendige Stücke
Paroi fixe - Paroi à commander

| | | | | |
|-----------------|----|---------|--------|----------|
| LRBAF 70 | 70 | 68 ÷ 69 | 371,00 | 1 |
| LRBAF 80 | 80 | 78 ÷ 79 | 395,00 | 1 |
| LRBAF 90 | 90 | 88 ÷ 89 | 407,00 | 1 |

PROFILO MAGGIORE ESTENSIBILITÀ

Wall profile adjustment - Verlängerungsprofil - Profilé pour extension supplémentaire

| Codice - Code Artikel - Article | Formato (cm) - Size Format - Dimension | + cm. | Prezzo (€) - Price Preis - Prix |
|---|--|--------------|---|
| MTP 05 | 3,1 x 200 | 1,0 | 48,00 |

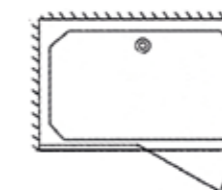
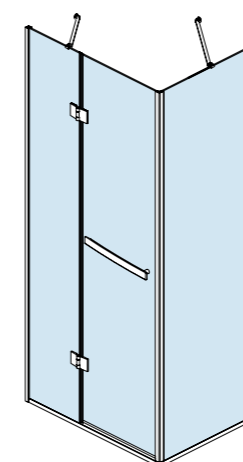
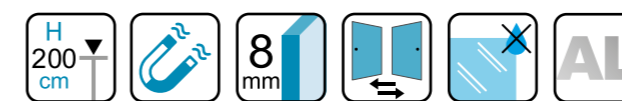

PROFILO A MURO
WALL PROFILE - WANDPROFIL - PROFIL DE MUR

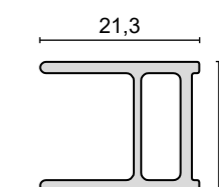

LACUS RIVESTE... SU MISURA - LACUS MAKES IT... TO MEASURE - LACUS FERTIG ...MASSGERECHT - LACUS UNE FABRICATION SUR ...MESURE

Articoli speciali su ordinazione - Special Items on request - Sonderanfertigungen auf Bestellung - Articles 'à la carte' sur commande

| | | |
|---|---|---|
| <p>LATO FISSO - FIXED PANEL <i>FESTE SEITENWAND - PANNEAU FIXE</i></p> | <p>LATO PORTA <i>DOOR - TÜR - PORTE</i></p> | <p>VETRO SOPRA MURETTO - GLASS ON THE WALL <i>GLAS AN DER WAND - PAROI SUR MURET</i></p> |
| <p>Altezza max 200 cm. - Larghezza max 125 cm. <i>Height max 200 cm. - Width max 125 cm.</i> Maximale Höhe 200 cm. - Maximale Breite 125 cm. <i>Hauteur 200 cm. maximum - Largeur 125 cm. maximum</i></p> | <p>Altezza max 200 cm. - Larghezza max 150 cm. <i>Height max 200 cm. - Width max 150 cm.</i> Maximale Höhe 200 cm. - Maximale Breite 150 cm. <i>Hauteur 200 cm. maximum - Largeur 150 cm. maximum</i></p> | <p>NON DISPONIBILE <i>NOT AVAILABLE</i> <i>NICHT VERFÜGBAR</i> <i>INDISPONIBLE</i></p> |
|  | | |

| | | |
|--|---|---|
| <p>PREZZO DI LISTINO AL PEZZO (TRASPARENTE) <i>GROSS PREIS PRO PIECE (TRANSPARENT)</i> <i>LISTENPREIS PRO STÜCK (TRANSPARENT)</i> <i>PRIX TARIF PAR PIÈCE (TRANSPARENT)</i></p> | <p>PREVENTIVO SU RICHIESTA <i>PRICE ON REQUEST</i> <i>ANGEBOT AUF ANFRAGE</i> <i>DEVIS SUR DEMANDE</i></p> | <p>NON DISPONIBILE <i>NOT AVAILABLE</i> <i>NICHT VERFÜGBAR</i> <i>INDISPONIBLE</i></p> |
|--|---|---|

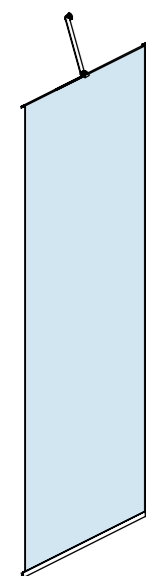
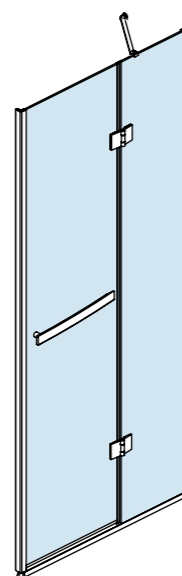
| | | | |
|--|--|--|---|
|  | <p>FASCIA 1: da 0,01 a 0,50 mq <i>Level 1:</i> <i>from 0.01 to 0.5 sqm</i></p> <p>€ 461,00</p> | | |
| | <p>FASCIA 2: da 0,51 a 1,00 mq <i>Level 2:</i> <i>from 0.51 to 1.0 sqm</i></p> <p>€ 562,00</p> | | |
| | <p>FASCIA 3: da 1,01 a 1,50 mq <i>Level 3:</i> <i>from 1.01 to 1.5 sqm</i></p> <p>€ 686,00</p> | | |
| | <p>FASCIA 4: da 1,51 a 2,00 mq <i>Level 4:</i> <i>from 1.51 to 2.0 sqm</i></p> <p>€ 793,00</p> |  | <p>NON DISPONIBILE <i>UNAVAILABLE</i> <i>NICHT VERFÜGBAR</i> <i>PAS DISPONIBLE</i></p> |
| | <p>FASCIA 5: da 2,01 a 2,50 mq <i>Level 5:</i> <i>from 2.01 to 2.5 sqm</i></p> <p>€ 893,00</p> | | |

Maggiorazione per vetro Matt e Gray: +15%
Surcharge for matt and grey crystal + 15%
Aufpreis für Matt und Grey Kristallglas +15%
Majoration pour les verres Mat et Grey: +15%

ATTENZIONE:
CALCOLARE I MQ. DEL PEZZO PER STABILIRE LA FASCIA DI APPARTENENZA
Per soluzioni diverse da quelle contemplate contattare ns. ufficio tecnico per avere indicazioni di fattibilità e prezzi.
VORSICHT:
BERECHNEN DIE QM. DES STÜCKES, ZUR ERFÜLLUNG DER ZUGEHÖRIGEN BAND
Für andere als die in Betracht gezogenen Lösungen wenden Sie sich an unser technisches Büro, um Informationen zu Machbarkeit und Preisen zu erhalten.

ATTENTION:
CALCULATE THE SQM OF THE ARTIKEL TO ESTABLISH THE BELONGING LEVEL.
For information on feasibility and prices of other solutions, please get in touch with our technical dept.
ATTENTION:
CALCULER LES M². DE LA PAROI POUR ÉTABLIR LA TRANCHE D'APPARTENANCE
Pour d'autres solutions que celles envisagées, contactez notre bureau technique pour connaître la faisabilité et les tarifs.

DETTAGLI & CARATTERISTICHE

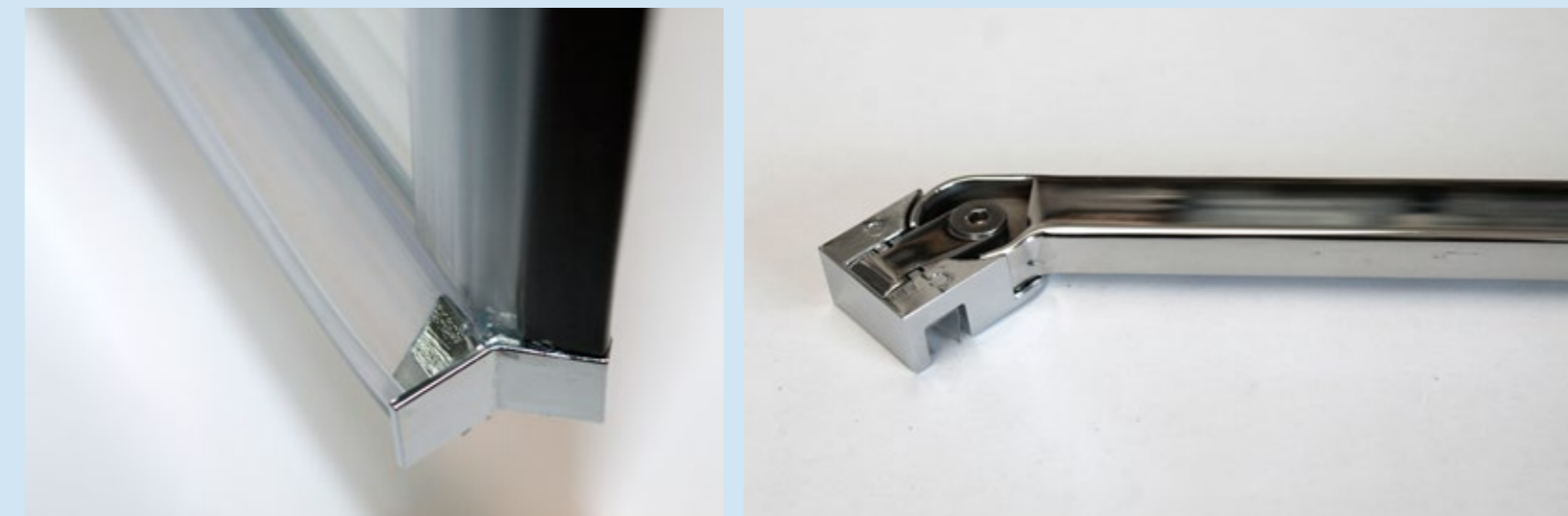

GUARNIZIONE INFERIORE
LOWER GASKET - BOTTOM GASKET - JOINT INFÉRIEURE

BRACCIO SNODABILE
ADJUSTABLE ARM - VERSTELLBARER ARM - BARRE DE RENFORT ARTICULÉE



MANIGLIA
HANDLE - GRIFF - POIGNÉE

CARATTERISTICHE GENERALI

- Cristallo temperato da 8 mm.
- Finitura trasparente.
- Profilo in alluminio cromo lucido.
- Chiusura magnetica delle ante.
- Chiusura ad anta battente.
- Estensione da 1 cm.
- Maniglie in alluminio, cerniere in ottone.
- Trattamento anticallcare.

GENERAL FEATURES

- 8 mm tempered safety crystal.
- Transparent.
- Polished aluminium profile.
- Magnetic waterproof closure.
- Outwards opening.
- Extension 1 cm.
- Handles of aluminium, hinges of brass.
- Descaling.

ALLGEMEINE SPEZIFIKATIONEN

- Sekurirkristallglas 8 mm stark.
- Kristallglasfinish: Transparent.
- Poliertes Chrom- Profil.
- Wasserdichtes Magnetverschluss der Türen.
- Drehtür.
- Streckbarkeit 1 cm.
- Griff aus Aluminium, Scharnier aus Messing.
- Entkalkungsbehandlung.

SPECIFICATIONS GENERALES

- Verre trempé 8 mm.
- Finition du verre: transparent.
- Profilé en aluminium chromé.
- Portes à fermeture magnétique.
- Ouverture pivotante.
- Extensibilité de 1 cm.
- Poignées et charnières en aluminium, laiton.
- Traitement anticallcaire.



TRATTAMENTO ANTICALCARE

Descaling
Entkalkungsbehandlung
Traitement anticalcaire

VENEZIA

CRISTALLO TRASPARENTE
TRANSPARENT CRYSTAL
TRANSPARENTES KRISTALLGLAS
VERRE TRANSPARENT

6 mm

BATTENTE PIVOT

| CODICE Code - Artikel - Article | Formato (cm) Size - Format - Dimension | Estensibilità Extensibility - Streckbarkeit - Extensibilität | Prezzo unitario Price - Preis - Prix | Lato porta Door - Tür - Porte | E cm | Ingombro porta Door space Tür-Raumbedarf - Passage |
|---|--|--|--|---|----------------|---|
| LAP 70 | 70 | 67 ÷ 69 | 675,00 | • | 54,4 | 33,5 |
| LAP 75 | 75 | 72 ÷ 74 | 682,00 | • | 59,1 | 36,0 |
| LAP 80 | 80 | 77 ÷ 79 | 698,00 | • | 63,7 | 38,5 |
| LAP 90 | 90 | 87 ÷ 89 | 721,00 | • | 72,9 | 43,5 |
| LAP 100 | 100 | 97 ÷ 99 | 743,00 | • | 82,1 | 48,5 |
| LAP 120 | 120 | 117 ÷ 119 | 788,00 | • | 100,5 | 58,5 |

*E: Spazio utile entrata - Entrance - Eingang - Entrée

***Prezzo: ATTENZIONE il prezzo è relativo ad un singolo lato.**

*Price: NOTICE: Price is for 1 side only.

*Preis: VORSICHT: Der Preis ist für eine einzelne Seite.

*Prix: ATTENTION: le prix est pour un seul côté.

PROFILO MAGGIORE ESTENSIBILITÀ

Wall profile adjustment - Verlängerungsprofil - Profilé pour extension supplémentaire

| Codice - Code Artikel - Article | Formato (cm) - Size Format - Dimension | + cm. | Prezzo (€) - Price Preis - Prix |
|---|--|--------------|---|
| MTP 03E | 5,4 x 190 | 2,0 | 65,00 |

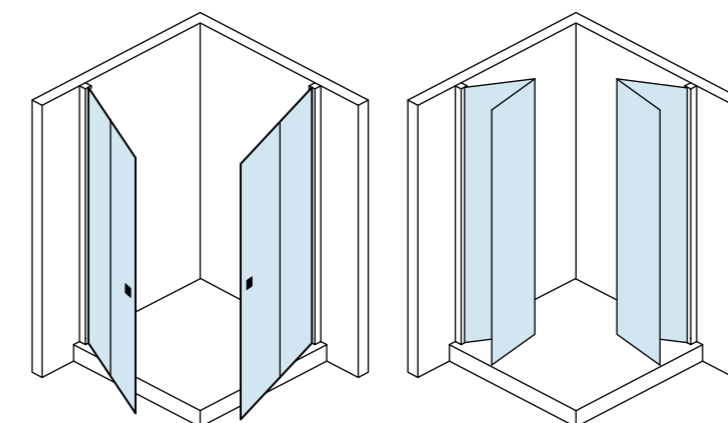

-BARRIERS FREE-

PROFILO A MURO WALL PROFILE - WANDPROFIL - PROFIL DE MUR

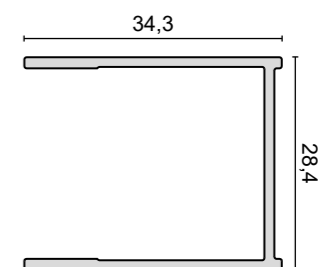

TRATTAMENTO ANTICALCARE

Descaling
Entkalkungsbehandlung
Traitement anticalcaire

CRISTALLO TRASPARENTE
TRANSPARENT CRYSTAL
TRANSPARENTES KRISTALLGLAS
VERRE TRANSPARENT

ALBARELLA

6 mm

BATTENTE PIVOT

| Codice Destro <i>Right Code - Tür Rechts Coté droit</i> | Codice Sinistro <i>Left Code - Tür Links Coté gauche</i> | Formato (cm) <i>Size - Format - Dimension</i> | Estensibilità <i>Extensibility Streckbarkeit Extensibilité</i> | Prezzo unitario <i>Price - Preis - Prix</i> | Lato porta <i>Door Tür - Porte</i> |  | Ingombro porta <i>Door space Tür-Raumbedarf Passage</i> |
|--|---|--|---|--|---|---|--|
| LAPN 7026-DX | LAPN 7026-SX | 70 | 67 ÷ 71 | 753,00 | • | 50,0 | 33,5 |
| LAPN 7526-DX | LAPN 7526-SX | 75 | 72 ÷ 76 | 763,00 | • | 55,0 | 36,0 |
| LAPN 8026-DX | LAPN 8026-SX | 80 | 77 ÷ 81 | 776,00 | • | 59,6 | 38,5 |
| LAPN 9026-DX | LAPN 9026-SX | 90 | 87 ÷ 91 | 798,00 | • | 68,8 | 43,5 |
| LAPN 10026-DX | LAPN 10026-SX | 100 | 97 ÷ 101 | 820,00 | • | 78,0 | 48,5 |
| LAPN 12026-DX | LAPN 12026-SX | 120 | 117 ÷ 121 | 865,00 | • | 96,3 | 58,5 |

PROFILO MAGGIORE ESTENSIBILITÀ

Wall profile adjustment - Verlängerungsprofil - Profilé pour extension supplémentaire

| Codice - Code Artikel - Article | Formato (cm) - Size Format - Dimension | + cm. | Prezzo (€) - Price Preis - Prix |
|------------------------------------|---|-------|------------------------------------|
| MTP 03E | 5,4 x 190 | 2,0 | 65,00 |

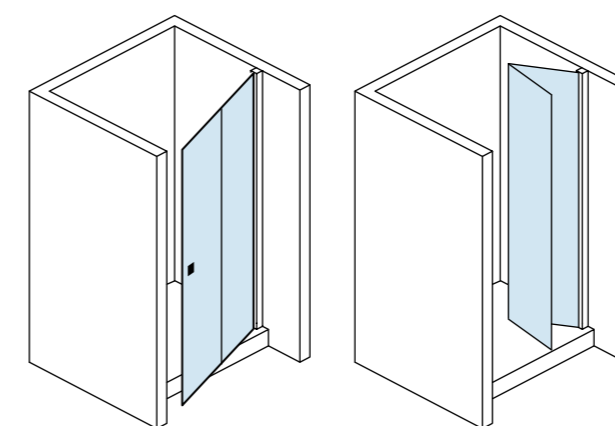

VERSIONE DX
Right model



-BARRIERS FREE-

PROFILO A MURO WALL PROFILE - WANDPROFIL - PROFIL DE MUR

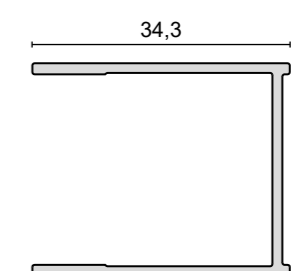

TRATTAMENTO ANTICALCARE

Descaling
Entkalkungsbehandlung
Traitement anticalcaire

ALBARELLA

CRISTALLO TRASPARENTE
TRANSPARENT CRYSTAL
TRANSPARENTES KRISTALLGLAS
VERRE TRANSPARENT

6 mm

BATTENTE PIVOT

| Codice Destro <i>Right Code - Tür Rechts Côté droit</i> | Codice Sinistro <i>Left Code - Tür Links Côté gauche</i> | Formato (cm) <i>Size - Format - Dimension</i> | Estensibilità <i>Extensibility Streckbarkeit Extensibilité</i> | Prezzo unitario <i>Price - Preis - Prix</i> | Lato porta <i>Door Tür - Porte</i> |  | Ingombro porta <i>Door space Tür-Raumbedarf Passage</i> |
|--|---|--|---|--|---|---|--|
| LAPN 7026-DX | LAPN 7026-SX | 70 | 67 ÷ 71 | 753,00 | • | 50,0 | 33,5 |
| LAPN 7526-DX | LAPN 7526-SX | 75 | 72 ÷ 76 | 763,00 | • | 55,0 | 36,0 |
| LAPN 8026-DX | LAPN 8026-SX | 80 | 77 ÷ 81 | 776,00 | • | 59,6 | 38,5 |
| LAPN 9026-DX | LAPN 9026-SX | 90 | 87 ÷ 91 | 798,00 | • | 68,8 | 43,5 |
| LAPN 10026-DX | LAPN 10026-SX | 100 | 97 ÷ 101 | 820,00 | • | 78,0 | 48,5 |
| LAPN 12026-DX | LAPN 12026-SX | 120 | 117 ÷ 121 | 865,00 | • | 96,3 | 58,5 |

Parete fissa - Pezzi da ordinare
*Side - Necessary pieces
Seite - Notwendige Stücke
Paroi fixe - Paroi à commander*

| | | | | |
|----------------|-----|---------|--------|---|
| LPB EVO 17016 | 70 | 67 ÷ 69 | 415,00 | 1 |
| LPB EVO 17516 | 75 | 72 ÷ 74 | 424,00 | 1 |
| LPB EVO 18016 | 80 | 77 ÷ 79 | 432,00 | 1 |
| LPB EVO 18516 | 85 | 82 ÷ 84 | 448,00 | 1 |
| LPB EVO 19016 | 90 | 87 ÷ 89 | 451,00 | 1 |
| LPB EVO 110016 | 100 | 97 ÷ 99 | 494,00 | 1 |

PROFILO MAGGIORE ESTENSIBILITÀ

Wall profile adjustment - Verlängerungsprofil - Profilé pour extension supplémentaire

| Codice - Code Artikel - Article | Formato (cm) - Size Format - Dimension | + cm. | Prezzo (€) - Price Preis - Prix |
|------------------------------------|---|-------|------------------------------------|
| MTP 03E | 5,4 x 190 | 2,0 | 65,00 |

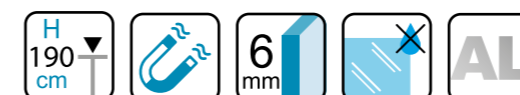

VERSIONE DX - RIGHT VERSION

VERSIONE SX - LEFT VERSION

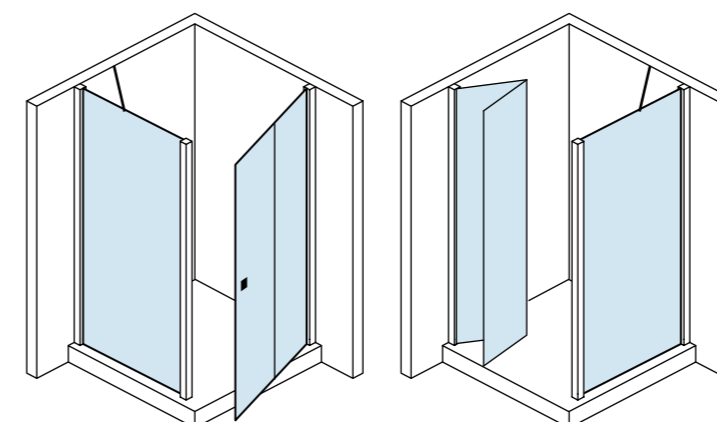

-BARRIERS FREE-

PROFILO A MURO
WALL PROFILE - WANDPROFIL - PROFIL DE MUR

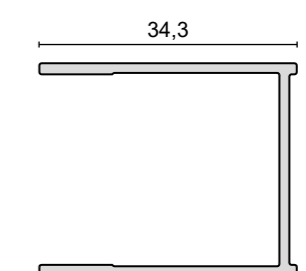

TRATTAMENTO ANTICALCARE

Descaling
Entkalkungsbehandlung
Traitement anticalcaire

ALBARELLA SALOON

CRISTALLO TRASPARENTE
TRANSPARENT CRYSTAL
TRANSPARENTES KRISTALLGLAS
VERRE TRANSPARENT

6 mm

BATTENTE PIVOT

| CODICE Code - Artikel - Article | Formato (cm) Size - Format - Dimension | Estensibilità Extensibility - Streckbarkeit - Extensibilité | Prezzo unitario Price - Preis - Prix | Lato porta Door - Tür - Porte | E cm | Ingombro porta Door space Tür-Raumbedarf - Passage |
|---|--|---|--|---|----------------|---|
| LAP 13046 | 130 | 127 ÷ 131 | 1.404,00 | • | 103,4 | 33,5 |
| LAP 13546 | 135 | 132 ÷ 136 | 1.411,00 | • | 107,7 | 33,5 |
| LAP 14046 | 140 | 137 ÷ 141 | 1.425,00 | • | 112,7 | 36,0 |
| LAP 14546 | 145 | 142 ÷ 146 | 1.444,00 | • | 116,7 | 36,0 |
| LAP 15046 | 150 | 147 ÷ 151 | 1.457,00 | • | 121,7 | 38,5 |
| LAP 16046 | 160 | 157 ÷ 161 | 1.484,00 | • | 131,7 | 43,5 |
| LAP 17046 | 170 | 167 ÷ 171 | 1.509,00 | • | 140,3 | 43,5 |
| LAP 18046 | 180 | 177 ÷ 181 | 1.536,00 | • | 150,3 | 48,5 |

Possibilità di formare 2° lato con modello LPBEV01 (pag. 81).
The 2nd side can be made with the LPBEV01 model (page 81).
Möglichkeit die 2.Seitenwand mit LPBEV01-Modell (S. 81) einzubauen.
Possibilité de réaliser le 2e côté avec le modèle LPBEV01 (page 81).

ATTENZIONE - ATTENTION
In caso di installazione con parete fissa, e' necessario il braccio di sostegno L.200.
In case of installation with fixed door the arm L.200 is necessary.
Für die Installation an einer fester Zur wird der Kragarm L.200 benötigt.
Pour la paroi fixe, prévoir une barre de renfort L.200.

| Codice - Code Artikel - Article | Formato (cm) - Size Format - Dimension | Prezzo (€) - Price Preis - Prix |
|---|--|---|
| BRACCIO L.200 | 2,5 x 1 x 200 | 115,00 |

PROFILO MAGGIORE ESTENSIBILITÀ

Wall profile adjustment - Verlängerungsprofil - Profilé pour extension supplémentaire

| Codice - Code Artikel - Article | Formato (cm) - Size Format - Dimension | + cm. | Prezzo (€) - Price Preis - Prix |
|---|--|--------------|---|
| MTP 03E | 5,4 x 190 | 2,0 | 65,00 |

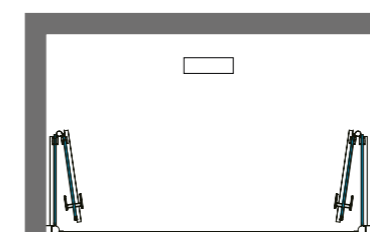
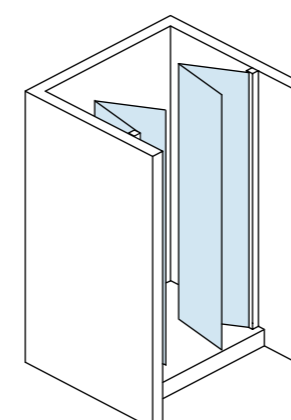

-BARRIERS FREE-

PROFILO A MURO WALL PROFILE - WANDPROFIL - PROFIL DE MUR

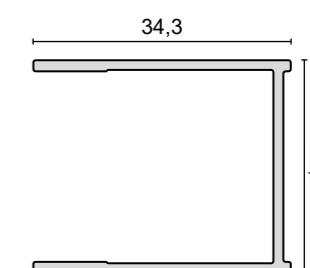

ALBARELLA / VENEZIA

LACUS RIVESTE... SU MISURA - LACUS MAKES IT... TO MEASURE - LACUS FERTIG ...MASSGERECHT - LACUS UNE FABRICATION SUR ...MESURE
 Articoli speciali su ordinazione - Special Items on request - Sonderanfertigungen auf Bestellung - Articles 'à la carte' sur commande

| | | |
|---|----------------------------------|---|
| LATO FISSO - FIXED PANEL FESTE SEITENWAND - PANNEAU FIXE | LATO PORTA DOOR - TÜR - PORTE | VETRO SOPRA MURETTO - GLASS ON THE WALL GLAS AN DER WAND - PAROI SUR MURET |
|---|----------------------------------|---|



| PREZZO DI LISTINO AL PEZZO (TRASPARENTE) GROSS PREIS PRO PIECE (TRANSPARENT) LISTENPREIS PRO STÜCK (TRANSPARENT) PRIX TARIF PAR PIÈCE (TRANSPARENT) | PREVENTIVO SU RICHIESTA PRICE ON REQUEST ANGEBOT AUF ANFRAGE DEVIS SUR DEMANDE | PREVENTIVO SU RICHIESTA PRICE ON REQUEST ANGEBOT AUF ANFRAGE DEVIS SUR DEMANDE |
|--|---|---|
| FASCIA 1: da 0,01 a 0,50 mq Level 1: from 0.01 to 0.5 sqm € 592,00 | ALBARELLA | |
| FASCIA 2: da 0,51 a 1,00 mq Level 2: from 0.51 to 1.0 sqm € 672,00 | | |
| FASCIA 3: da 1,01 a 1,50 mq Level 3: from 1.01 to 1.5 sqm € 768,00 | | |
| FASCIA 4: da 1,51 a 2,00 mq Level 4: from 1.51 to 2.0 sqm € 850,00 | | |
| FASCIA 5: da 2,01 a 2,50 mq Level 5: from 2.01 to 2.5 sqm € 934,00 | | |
| FASCIA 6: da 2,51 a 3,00 mq Level 6: from 2.51 to 3.0 sqm € 1.040,00 | | |

Maggiorazione per vetro Matt, Fox e Gray: +15%
 Surcharge for matt, fox and grey crystal + 15%
 Aufpreis für Matt, Fox und Grey Kristallglas +15%
 Majoration pour les verres Matt, Fox et Grey: +15%

| | | |
|--|--------------------|--|
| NON DISPONIBILE UNAVAILABLE NICHT VERFÜGBAR PAS DISPONIBLE | VENEZIA | NON DISPONIBILE UNAVAILABLE NICHT VERFÜGBAR PAS DISPONIBLE |
|--|--------------------|--|

ATTENZIONE:
CALCOLARE I MQ. DEL PEZZO PER STABILIRE LA FASCIA DI APPARTENENZA
 Per soluzioni diverse da quelle contemplate contattare ns. ufficio tecnico per avere indicazioni di fattibilità e prezzi.
VORSICHT:
BERECHNEN DIE QM. DES STÜCKES, ZUR ERFÜLLUNG DER ZUGEHÖRIGEN BAND
 Für andere als die in Betracht gezogenen Lösungen wenden Sie sich an unser technisches Büro, um Informationen zu Machbarkeit und Preisen zu erhalten.

ATTENTION:
CALCULATE THE SQM OF THE ARTIKEL TO ESTABLISH THE BELONGING LEVEL.
 For information on feasibility and prices of other solutions, please get in touch with our technical dept.
ATTENTION:
CALCULER LES M². DE LA PAROI POUR ÉTABLIR LA TRANCHE D'APPARTENANCE
 Pour d'autres solutions que celles envisagées, contactez notre bureau technique pour connaître la faisabilité et les tarifs.

DETTAGLI & CARATTERISTICHE

6 mm
 BATTENTE
 PIVOT



PROFILO E CERNIERA - PROFILE AND HINGE
 PROFIL UND SCHARNIER - PROFILÉ ET CHARNIÈRE



POMOLO
 KNOB - KNOPF - POIGNÉE



CERNIERA CENTRALE - MIDDLE HINGE
 MITTLESCHARNIERE, CHARNIÈRE CENTRALE

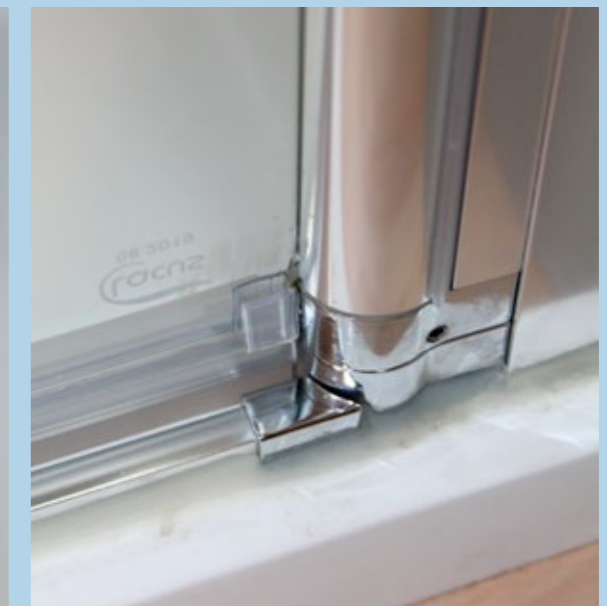

GUARNIZIONE INFERIORE - BOTTOM GASKET
 UNTERE DICHTUNG - JOINT INFÉRIEURE

CARATTERISTICHE GENERALI

- Cristallo temperato da 6 mm.
- Finitura trasparente.
- Profilo in alluminio cromo lucido.
- Chiusura magnetica delle ante.
- Chiusura ad anta battente e pieghevole.
- Estensione da 2 cm.
- Pomolo e cerniere in zama.

GENERAL FEATURES

- 6 mm tempered safety crystal.
- Transparent crystal.
- Polished aluminum profile.
- Magnetic waterproof closure.
- Folding pivoting door.
- Extension 2 cm.
- Knob and hinges made of zinc alloy.

ALLGEMEINE SPEZIFIKATIONEN

- Kristallglasfinish: Transparent.
- Poliertes Chrom Profil.
- Wasserdichtes Magnetverschluß der Türen.
- Faltbarer Drehtür.
- Streckbarkeit 2 cm.
- Knopf und Scharnier aus Zamak.

SPECIFICATIONS GENERALES

- Verre trempé 6 mm.
- Finition du verre: transparent.
- Profilé en aluminium chromé.
- Portes à fermeture magnétique.
- Ouverture pivotante.
- Extensibilité de 2 cm.
- Poignée et charnière en zamak.

TRATTAMENTO ANTICALCARE

Descaling
Entkalkungsbehandlung
Traitement anticalcaire



TREMITI

PROFILO NERO SATINATO - CRISTALLO TRASPARENTE
BLACK SATIN PROFILE - TRANSPARENT CRYSTAL
SCHWARZ-SATINIERTES PROFIL - TRANSPARENTES KRISTALLGLAS
PROFILÉ NOIR SATINÉ - VERRRE TRANSPARENT

6 mm

BATTENTE PIVOT

| CODICE <i>Code - Artikel - Article</i> | MOD. | Formato (cm) <i>Size - Format - Dimension</i> | Estensibilità <i>Extensibility - Streckbarkeit - Extensibilité</i> | Prezzo unitario <i>Price - Preis - Prix</i> | E <i>cm</i> | Ingombro porta <i>Door space - Tür-Raumbedarf - Passage</i> | Lato porta <i>Door - Tür - Porte</i> |
|--|-------------|---|--|---|-----------------------|---|--|
| LPBT 6016 | A | 60 | 57 ÷ 60 | 678,00 | 45,5 | 45,5 | • |
| LPBT 7016 | A | 70 | 67 ÷ 70 | 718,00 | 55,5 | 55,5 | • |
| LPBT 7516 | A | 75 | 72 ÷ 75 | 736,00 | 60,5 | 60,5 | • |
| LPBT 8016 | A | 80 | 77 ÷ 80 | 755,00 | 65,5 | 65,5 | • |
| LPBT 9016 | A | 90 | 87 ÷ 90 | 797,00 | 75,5 | 75,5 | • |

Parete fissa - Pezzi da ordinare
Side - Necessary pieces - Seite - Notwendige Stücke - Paroi fixe - Paroi à commander

| | | | | | |
|-----------|---|----|-----------|--------|-----|
| LAFT 3016 | B | 30 | 30 ÷ 30,5 | 359,00 | 1/2 |
| LAFT 3516 | B | 35 | 35 ÷ 35,5 | 376,00 | 1/2 |
| LAFT 4016 | B | 40 | 40 ÷ 40,5 | 395,00 | 1/2 |

PROFILO MAGGIORE ESTENSIBILITÀ

Wall profile adjustment - Verlängerungsprofil - Profilé pour extension supplémentaire

| Codice - Code <i>Artikel - Article</i> | Formato (cm) - Size <i>Format - Dimension</i> | + cm. | Prezzo (€) - Price <i>Preis - Prix</i> |
|--|---|--------------|--|
| MTP 26 | 1,5 x 200 | 1,5 | 100,00 |

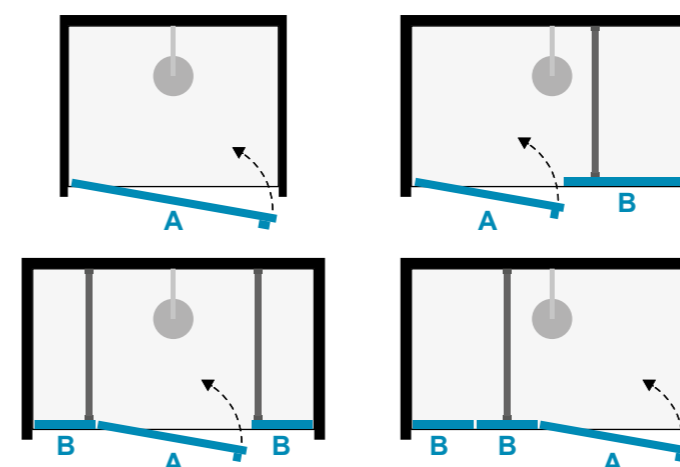

PROFILO A MURO
WALL PROFILE - WANDPROFIL - PROFIL DE MUR

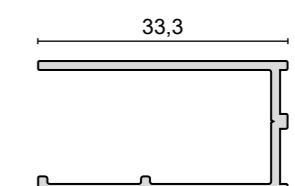

TRATTAMENTO ANTICALCARE

Descaling
Entkalkungsbehandlung
Traitement anticalcaire



Mod. A+C

TREMITI

PROFILO NERO SATINATO - CRISTALLO TRASPARENTE

BLACK SATIN PROFILE - TRANSPARENT CRYSTAL
SCHWARZ-SATINIERTES PROFIL - TRANSPARENTES KRISTALLGLAS
PROFILÉ NOIR SATINÉ - VERRE TRANSPARENT

6 mm

BATTENTE PIVOT

| CODICE <i>Code - Artikel - Article</i> | MOD. | Formato (cm) <i>Size - Format - Dimension</i> | Estensibilità <i>Extensibility - Streckbarkeit - Extensibilité</i> | Prezzo unitario <i>Price - Preis - Prix</i> | E <i>cm</i> | Ingombro porta <i>Door space - Tür-Raumbedarf - Passage</i> | Lato porta <i>Door - Tür - Porte</i> |
|--|-------------|---|--|---|-----------------------|---|--|
| LPBT 6016 | A | 60 | 57 ÷ 60 | 678,00 | 45,5 | 45,5 | • |
| LPBT 7016 | A | 70 | 67 ÷ 70 | 718,00 | 55,5 | 55,5 | • |
| LPBT 7516 | A | 75 | 72 ÷ 75 | 736,00 | 60,5 | 60,5 | • |
| LPBT 8016 | A | 80 | 77 ÷ 80 | 755,00 | 65,5 | 65,5 | • |
| LPBT 9016 | A | 90 | 87 ÷ 90 | 797,00 | 75,5 | 75,5 | • |

Parete fissa - Pezzi da ordinare
Side - Necessary pieces - Seite - Notwendige Stücke - Paroi fixe - Paroi à commander

| | | | | | |
|------------|---|----|-----------|--------|-----|
| LAFT 3016 | B | 30 | 30 ÷ 30,5 | 359,00 | 1/2 |
| LAFT 3516 | B | 35 | 35 ÷ 35,5 | 376,00 | 1/2 |
| LAFT 4016 | B | 40 | 40 ÷ 40,5 | 395,00 | 1/2 |
| LPFT 17016 | C | 70 | 68 ÷ 69,5 | 433,00 | 1/2 |
| LPFT 17516 | C | 75 | 73 ÷ 74,5 | 453,00 | 1/2 |
| LPFT 18016 | C | 80 | 78 ÷ 79,5 | 472,00 | 1/2 |
| LPFT 19016 | C | 90 | 88 ÷ 89,5 | 510,00 | 1/2 |

PROFILO MAGGIORE ESTENSIBILITÀ

Wall profile adjustment - Verlängerungsprofil - Profilé pour extension supplémentaire

| Codice - Code - Artikel - Article | Formato (cm) - Size - Format - Dimension | + cm. | Prezzo (€) - Price - Preis - Prix |
|--|---|--------------|--|
| MTP 26 | 1,5 x 200 | 1,5 | 100,00 |



PROFILO A MURO WALL PROFILE - WANDPROFIL - PROFIL DE MUR

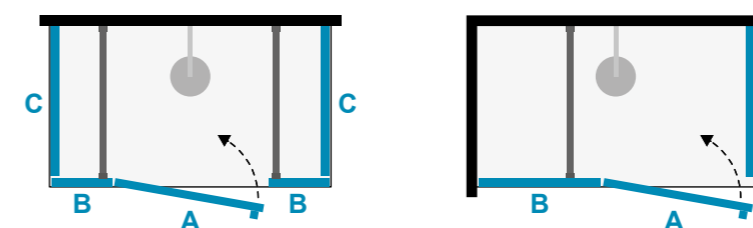
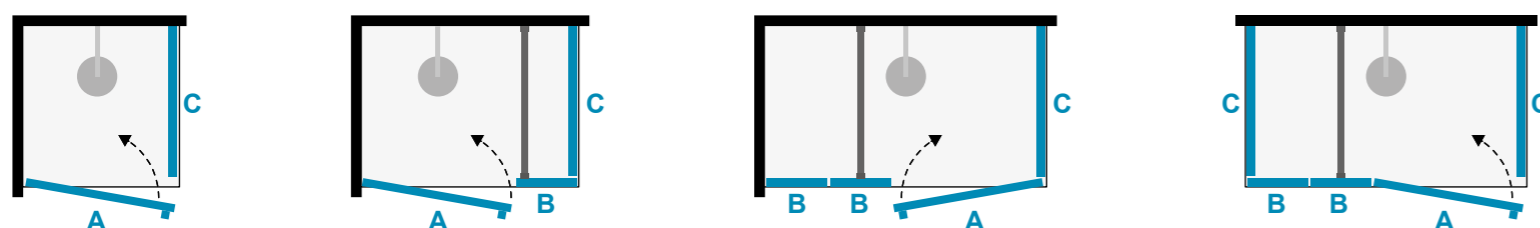

| LACUS RIVESTE... SU MISURA - LACUS MAKES IT... TO MEASURE - LACUS FERTIG ...MASSGERECHT - LACUS UNE FABRICATION SUR ...MESURE | | |
|---|---|---|
| Articoli speciali su ordinazione - Special Items on request - Sonderanfertigungen auf Bestellung - Articles 'à la carte' sur commande | | |
| LATO FISSO - FIXED PANEL FESTE SEITENWAND - PANNEAU FIXE | LATO PORTA DOOR - TÜR - PORTE | VETRO SOPRA MURETTO - GLASS ON THE WALL GLAS AN DER WAND - PAROI SUR MURET |
| NON DISPONIBILE UNAVAILABLE NICHT VERFÜGBAR PAS DISPONIBLE | NON DISPONIBILE UNAVAILABLE NICHT VERFÜGBAR PAS DISPONIBLE | NON DISPONIBILE UNAVAILABLE NICHT VERFÜGBAR PAS DISPONIBLE |
| NON DISPONIBILE UNAVAILABLE NICHT VERFÜGBAR PAS DISPONIBLE | NON DISPONIBILE UNAVAILABLE NICHT VERFÜGBAR PAS DISPONIBLE | NON DISPONIBILE UNAVAILABLE NICHT VERFÜGBAR PAS DISPONIBLE |
| NON DISPONIBILE UNAVAILABLE NICHT VERFÜGBAR PAS DISPONIBLE | NON DISPONIBILE UNAVAILABLE NICHT VERFÜGBAR PAS DISPONIBLE | NON DISPONIBILE UNAVAILABLE NICHT VERFÜGBAR PAS DISPONIBLE |



MANIGLIA - PROFILI ORIZZONTALI - VITI DI FISSAGGIO
HANDLE - HORIZONTAL PROFILES - FIXING SCREWS.
GRIFF - HORIZONTALS PROFILE - BEFESTIGUNGSSCHRAUBEN.
POIGNÉE - PROFILÉS HORIZONTAUX - VIS DE FIXATION.

CARATTERISTICHE GENERALI

- Cristallo temperato da 6 mm.
- Finitura trasparente.
- Profilo in alluminio nero satinato.
- Chiusura magnetica delle ante.
- Chiusura ad anta battente.
- Estensione da 1,5 cm.
- Maniglia in alluminio.

GENERAL FEATURES

- 6 mm tempered safety crystal.
- Transparent crystal.
- Polished aluminum black satin profile.
- Magnetic waterproof closure.
- Outwards/inwards opening.
- Extension 1,5 cm.
- Handle made of aluminium.

ALLGEMEINE SPEZIFIKATIONEN

- Sekurirkristallglas 6 mm stark.
- Kristallglasfinish: Transparent.
- Schwarzes satiniertes Aluminium Profil.
- Wasserdichtes Magnetverschluß der Türen.
- Drehtür.
- Streckbarkeit 1,5 cm.
- Griff aus Aluminium.

SPECIFICATIONS GENERALES

- Verre trempé 6 mm.
- Finition du verre: transparent.
- Profilé en aluminium noir satiné.
- Portes à fermeture magnétique.
- Ouverture pivotante.
- Extensibilité de 1,5 cm.
- Poignée en aluminium.



TRATTAMENTO ANTICALCARE

Descaling
Entkalkungsbehandlung
Traitement anticalcaire



GRADO

CRISTALLO TRASPARENTE
TRANSPARENT CRYSTAL
TRANSPARENTES KRISTALLGLAS
VERRE TRANSPARENT

6 mm

BATTENTE PIVOT

| CODICE Code - Artikel - Article | Formato (cm) Size - Format - Dimension | Estensibilità Extensibility - Streckbarkeit - Extensibilité | Prezzo unitario Price - Preis - Prix | E cm | Ingombro porta Door space Tür-Raumbedarf Passage | Lato porta Door - Tür - Porte |
|---|--|---|--|----------------|--|---|
| LPBMG 7026 | 70 | 67,5 ÷ 69 | 472,00 | 34,0 | 34,0 | • |
| LPBMG 8026 | 80 | 77,5 ÷ 79 | 498,00 | 44,0 | 44,0 | • |
| LPBMG 9026 | 90 | 87,5 ÷ 89 | 502,00 | 54,0 | 54,0 | • |
| LPBMG 10026 | 100 | 97,5 ÷ 99 | 521,00 | 59,0 | 59,0 | • |
| LPBMG 11026 | 110 | 107,5 ÷ 109 | 545,00 | 59,0 | 59,0 | • |
| LPBMG 12026 | 120 | 117,5 ÷ 119 | 569,00 | 59,0 | 59,0 | • |
| LPBMG 13026 | 130 | 127,5 ÷ 129 | 593,00 | 59,0 | 59,0 | • |
| LPBMG 14026 | 140 | 137,5 ÷ 139 | 616,00 | 59,0 | 59,0 | • |
| Parete fissa Side - Seite Paroi fixe | | | | | | |
| LPMTF 7016 | 70 | 67,5 ÷ 69 | 270,00 | | • | |
| LPMTF 7516 | 75 | 72,5 ÷ 74 | 291,00 | | • | |
| LPMTF 8016 | 80 | 77,5 ÷ 79 | 293,00 | | • | |
| LPMTF 9016 | 90 | 87,5 ÷ 89 | 316,00 | | • | |

PROFILO MAGGIORE ESTENSIBILITÀ

Wall profile adjustment - Verlängerungsprofil - Profilé pour extension supplémentaire

| Codice - Code Artikel - Article | Formato (cm) - Size Format - Dimension | + cm. | Prezzo (€) - Price Preis - Prix |
|---|--|--------------|---|
| MTP 28 | 4,2 x 200 | 1,5 | 55,00 |

Possibilità di formare 3° lato con modello LPMTF.
The 3rd side can be made with the LPMTF model.
Möglichkeit die 3. Seitenwand mit LPMTF-Modell einzubauen.
Possibilité de réaliser le 3e côté avec le modèle LPMTF.

PROFILO MAGGIORE ESTENSIBILITÀ PER LATO FISSO

Wall profile adjustment for side - Verlängerungsprofil für Seitenwand
Profilé pour extension supplémentaire de la paroi fixe

| Codice - Code Artikel - Article | Formato (cm) - Size Format - Dimension | + cm. | Prezzo (€) - Price Preis - Prix |
|---|--|--------------|---|
| MTP 29 | 4,6 x 200 | 1,5 | 55,00 |

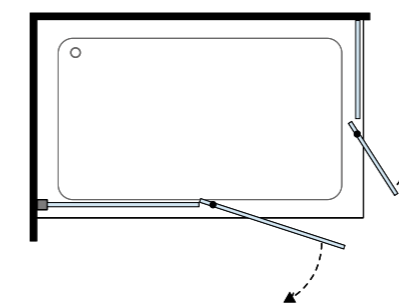
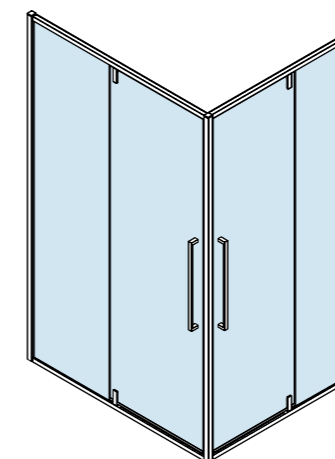

PROFILO A MURO LATO PORTA
WALL PROFILE FOR DOOR
WANDPROFIL FÜR TÜRSEITE
PROFIL DE MUR COTE PORTE

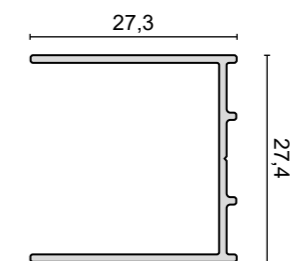

PROFILO A MURO LATO FISSO
WALL PROFILE SIDE PANEL
WANDPROFIL FÜR SEITENWAND
PROFIL DE MUR LATÉRAL FIXE

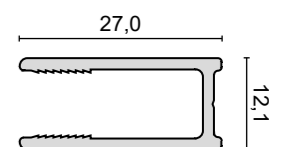

TRATTAMENTO ANTICALCARE

Descaling
Entkalkungsbehandlung
Traitement anticalcaire

GRADO BLACK

CRISTALLO TRASPARENTE
TRANSPARENT CRYSTAL
TRANSPARENTES KRISTALLGLAS
VERRE TRANSPARENT

6 mm

BATTENTE PIVOT

| CODICE <i>Code - Artikel - Article</i> | Formato (cm) <i>Size - Format - Dimension</i> | Estensibilità <i>Extensibility - Streckbarkeit - Extensibilité</i> | Prezzo unitario <i>Price - Preis - Prix</i> | E <i>cm</i> | Ingombro porta <i>Door space Tür-Raumbedarf Passage</i> | Lato porta <i>Door - Tür - Porte</i> |
|---|--|---|--|-----------------------|--|---|
| LPBMG 7026B | 70 | 67,5 ÷ 69 | 472,00 | 34,0 | 34,0 | • |
| LPBMG 8026B | 80 | 77,5 ÷ 79 | 498,00 | 44,0 | 44,0 | • |
| LPBMG 9026B | 90 | 87,5 ÷ 89 | 502,00 | 54,0 | 54,0 | • |
| LPBMG 10026B | 100 | 97,5 ÷ 99 | 521,00 | 59,0 | 59,0 | • |
| LPBMG 11026B | 110 | 107,5 ÷ 109 | 545,00 | 59,0 | 59,0 | • |
| LPBMG 12026B | 120 | 117,5 ÷ 119 | 569,00 | 59,0 | 59,0 | • |
| LPBMG 13026B | 130 | 127,5 ÷ 129 | 593,00 | 59,0 | 59,0 | • |
| LPBMG 14026B | 140 | 137,5 ÷ 139 | 616,00 | 59,0 | 59,0 | • |
| Parete fissa <i>Side - Seite Paroi fixe</i> | | | | | | |
| LPMTF 7016B | 70 | 67,5 ÷ 69 | 270,00 | | • | |
| LPMTF 7516B | 75 | 72,5 ÷ 74 | 291,00 | | • | |
| LPMTF 8016B | 80 | 77,5 ÷ 79 | 293,00 | | • | |
| LPMTF 9016B | 90 | 87,5 ÷ 89 | 316,00 | | • | |

PROFILO MAGGIORE ESTENSIBILITÀ

Wall profile adjustment - Verlängerungsprofil - Profilé pour extension supplémentaire

| Codice - Code Artikel - Article | Formato (cm) - Size Format - Dimension | + cm. | Prezzo (€) - Price Preis - Prix |
|------------------------------------|---|-------|------------------------------------|
| MTP 28B | 4,2 x 200 | 1,5 | 55,00 |

Possibilità di formare 3° lato con modello LPMTF B.
The 3rd side can be made with the LPMTF B model.
Möglichkeit die 3. Seitenwand mit LPMTF B -Modell einzubauen.
Possibilité de réaliser le 3e côté avec le modèle LPMTF B.

PROFILO MAGGIORE ESTENSIBILITÀ PER LATO FISSO

Wall profile adjustment for side - Verlängerungsprofil für Seitenwand
Profilé pour extension supplémentaire de la paroi fixe

| Codice - Code Artikel - Article | Formato (cm) - Size Format - Dimension | + cm. | Prezzo (€) - Price Preis - Prix |
|------------------------------------|---|-------|------------------------------------|
| MTP 29B | 4,6 x 200 | 1,5 | 55,00 |

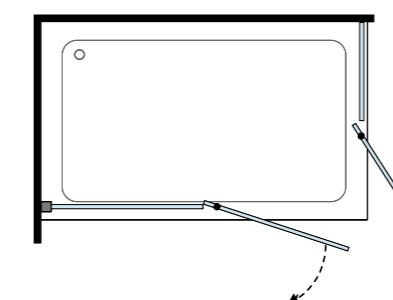
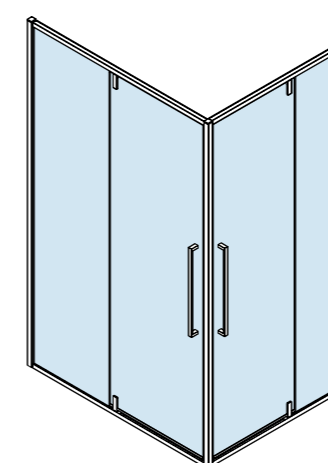

PROFILO A MURO LATO PORTA
WALL PROFILE FOR DOOR
WANDPROFIL FÜR TÜRSEITE
PROFIL DE MUR COTE PORTE

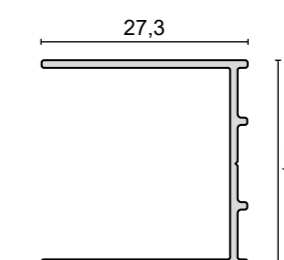

PROFILO A MURO LATO FISSO
WALL PROFILE SIDE PANEL
WANDPROFIL FÜR SEITENWAND
PROFIL DE MUR LATÉRAL FIXE

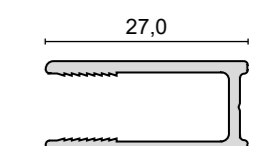

TRATTAMENTO ANTICALCARE

Descaling
Entkalkungsbehandlung
Traitement anticalcaire

GRADO WHITE

CRISTALLO TRASPARENTE
TRANSPARENT CRYSTAL
TRANSPARENTES KRISTALLGLAS
VERRE TRANSPARENT

6 mm

BATTENTE PIVOT

| CODICE <i>Code - Artikel - Article</i> | Formato (cm) <i>Size - Format - Dimension</i> | Estensibilità <i>Extensibility - Streckbarkeit - Extensibilité</i> | Prezzo unitario <i>Price - Preis - Prix</i> | E <i>cm</i> | Ingombro porta <i>Door space Tür-Raumbedarf Passage</i> | Lato porta <i>Door - Tür - Porte</i> |
|---|---|--|---|-----------------------|---|--|
| LPBMG 7026W | 70 | 67,5 ÷ 69 | 472,00 | 34,0 | 34,0 | • |
| LPBMG 8026W | 80 | 77,5 ÷ 79 | 498,00 | 44,0 | 44,0 | • |
| LPBMG 9026W | 90 | 87,5 ÷ 89 | 502,00 | 54,0 | 54,0 | • |
| LPBMG 10026W | 100 | 97,5 ÷ 99 | 521,00 | 59,0 | 59,0 | • |
| LPBMG 11026W | 110 | 107,5 ÷ 109 | 545,00 | 59,0 | 59,0 | • |
| LPBMG 12026W | 120 | 117,5 ÷ 119 | 569,00 | 59,0 | 59,0 | • |
| LPBMG 13026W | 130 | 127,5 ÷ 129 | 593,00 | 59,0 | 59,0 | • |
| LPBMG 14026W | 140 | 137,5 ÷ 139 | 616,00 | 59,0 | 59,0 | • |
| Parete fissa <i>Side - Seite Paroi fixe</i> | | | | | | |
| LPMTF 7016W | 70 | 67,5 ÷ 69 | 270,00 | | • | |
| LPMTF 7516W | 75 | 72,5 ÷ 74 | 291,00 | | • | |
| LPMTF 8016W | 80 | 77,5 ÷ 79 | 293,00 | | • | |
| LPMTF 9016W | 90 | 87,5 ÷ 89 | 316,00 | | • | |

PROFILO MAGGIORE ESTENSIBILITÀ

Wall profile adjustment - Verlängerungsprofil - Profilé pour extension supplémentaire

| Codice - Code <i>Artikel - Article</i> | Formato (cm) - Size <i>Format - Dimension</i> | + cm. | Prezzo (€) - Price <i>Preis - Prix</i> |
|--|---|--------------|--|
| MTP 28W | 4,2 x 200 | 1,5 | 55,00 |

Possibilità di formare 3° lato con modello LPMTF W.
The 3rd side can be made with the LPMTF W model.
Möglichkeit die 3. Seitenwand mit LPMTF W-Modell einzubauen.
Possibilité de réaliser le 3e côté avec le modèle LPMTF W.

PROFILO MAGGIORE ESTENSIBILITÀ PER LATO FISSO

Wall profile adjustment for side - Verlängerungsprofil für Seitenwand
Profilé pour extension supplémentaire de la paroi fixe

| Codice - Code <i>Artikel - Article</i> | Formato (cm) - Size <i>Format - Dimension</i> | + cm. | Prezzo (€) - Price <i>Preis - Prix</i> |
|--|---|--------------|--|
| MTP 29W | 4,6 x 200 | 1,5 | 55,00 |

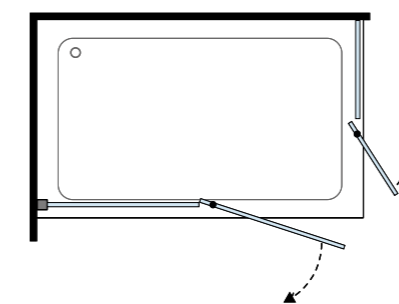
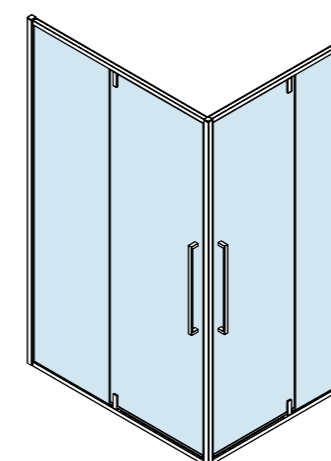

PROFILO A MURO LATO PORTA
WALL PROFILE FOR DOOR
WANDPROFIL FÜR TÜRSEITE
PROFIL DE MUR COTE PORTE

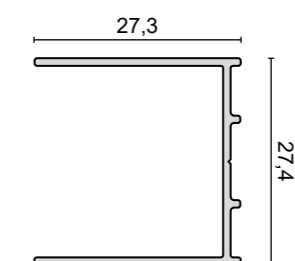

PROFILO A MURO LATO FISSO
WALL PROFILE SIDE PANEL
WANDPROFIL FÜR SEITENWAND
PROFIL DE MUR LATÉRAL FIXE

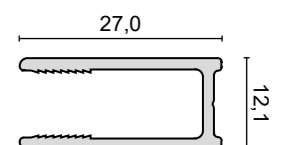

TRATTAMENTO ANTICALCARE

Descaling
Entkalkungsbehandlung
Traitement anticalcaire

CRISTALLO TRASPARENTE
TRANSPARENT CRYSTAL
TRANSPARENTES KRISTALLGLAS
VERRE TRANSPARENT

MURANO

6 mm

BATTENTE PIVOT

| CODICE <i>Code - Artikel - Article</i> | Formato (cm) <i>Size - Format - Dimension</i> | Estensibilità <i>Extensibility - Streckbarkeit - Extensibilité</i> | Prezzo unitario <i>Price - Preis - Prix</i> | E <i>cm</i> | Ingombro porta <i>Door space Tür-Raumbedarf Passage</i> | Lato porta <i>Door - Tür - Porte</i> |
|--|---|--|---|-----------------------|---|--|
| LPBM 9026 | 90 | 87 ÷ 90 | 502,00 | 54,0 | 54,0 | • |
| LPBM 10026 | 100 | 97 ÷ 100 | 521,00 | 59,0 | 59,0 | • |
| LPBM 11026 | 110 | 107 ÷ 110 | 545,00 | 59,0 | 59,0 | • |
| LPBM 12026 | 120 | 117 ÷ 120 | 569,00 | 59,0 | 59,0 | • |
| LPBM 13026 | 130 | 127 ÷ 130 | 593,00 | 59,0 | 59,0 | • |
| LPBM 14026 | 140 | 137 ÷ 140 | 616,00 | 59,0 | 59,0 | • |

PROFILO MAGGIORE ESTENSIBILITÀ

Wall profile adjustment - Verlängerungsprofil - Profilé pour extension supplémentaire

| Codice - Code <i>Artikel - Article</i> | Formato (cm) - Size <i>Format - Dimension</i> | + cm. | Prezzo (€) - Price <i>Preis - Prix</i> |
|--|---|--------------|--|
| MTP 28 | 4,2 x 200 | 1,5 | 55,00 |

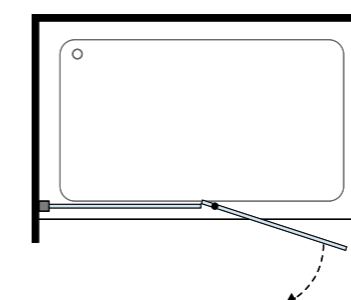
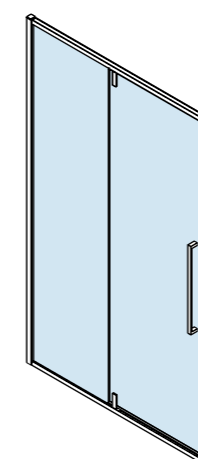

PROFILO A MURO LATO PORTA
*WALL PROFILE FOR DOOR
WANDPROFIL FÜR TÜRSEITE
PROFIL DE MUR COTE PORTE*

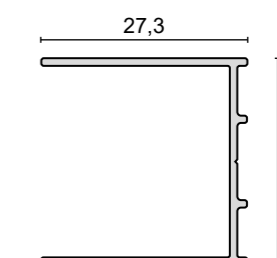

TRATTAMENTO ANTICALCARE

Descaling
Entkalkungsbehandlung
Traitement anticalcaire



MURANO

CRISTALLO TRASPARENTE
TRANSPARENT CRYSTAL
TRANSPARENTES KRISTALLGLAS
VERRE TRANSPARENT

6 mm

BATTENTE PIVOT

| CODICE <i>Code - Artikel - Article</i> | Formato (cm) <i>Size - Format - Dimension</i> | Estensibilità <i>Extensibility - Streckbarkeit - Extensibilité</i> | Prezzo unitario <i>Price - Preis - Prix</i> | E <i>cm</i> | Ingombro porta <i>Door space Tür-Raumbedarf Passage</i> | Lato porta <i>Door - Tür - Porte</i> |
|--|---|--|---|-----------------------|---|--|
| LPBM 9026 | 90 | 87 ÷ 90 | 502,00 | 54,0 | 54,0 | • |
| LPBM 10026 | 100 | 97 ÷ 100 | 521,00 | 59,0 | 59,0 | • |
| LPBM 11026 | 110 | 107 ÷ 110 | 545,00 | 59,0 | 59,0 | • |
| LPBM 12026 | 120 | 117 ÷ 120 | 569,00 | 59,0 | 59,0 | • |
| LPBM 13026 | 130 | 127 ÷ 130 | 593,00 | 59,0 | 59,0 | • |
| LPBM 14026 | 140 | 137 ÷ 140 | 616,00 | 59,0 | 59,0 | • |

Parete fissa - Pezzi da ordinare
*Side - Necessary pieces
Seite - Notwendige Stücke
Paroi fixe - Paroi à commander*

| | | | | |
|-------------------|----|-----------|--------|----------|
| LPMTF 7016 | 70 | 67,5 ÷ 69 | 270,00 | 1 |
| LPMTF 7516 | 75 | 72,5 ÷ 74 | 291,00 | 1 |
| LPMTF 8016 | 80 | 77,5 ÷ 79 | 293,00 | 1 |
| LPMTF 9016 | 90 | 87,5 ÷ 89 | 316,00 | 1 |

PROFILO MAGGIORE ESTENSIBILITÀ PER LATO PORTA

Wall profile adjustment - Verlängerungsprofil - Profilé pour extension supplémentaire

| Codice - Code <i>Artikel - Article</i> | Formato (cm) - Size <i>Format - Dimension</i> | + cm. | Prezzo (€) - Price <i>Preis - Prix</i> |
|--|---|--------------|--|
| MTP 28 | 4,2 x 200 | 1,5 | 55,00 |

PROFILO MAGGIORE ESTENSIBILITÀ PER LATO FISSO

*Wall profile adjustment for side - Verlängerungsprofil für Seitenwand
Profilé pour extension supplémentaire de la paroi fixe*

| Codice - Code <i>Artikel - Article</i> | Formato (cm) - Size <i>Format - Dimension</i> | + cm. | Prezzo (€) - Price <i>Preis - Prix</i> |
|--|---|--------------|--|
| MTP 29 | 4,6 x 200 | 1,5 | 55,00 |

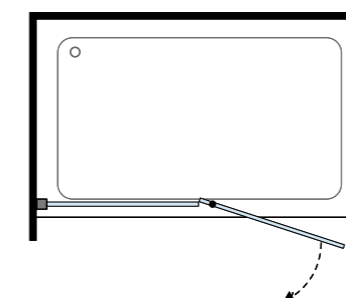
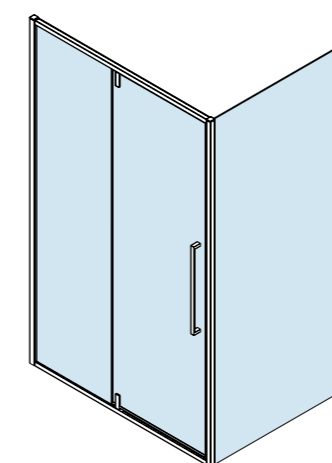

PROFILO A MURO LATO PORTA
*WALL PROFILE FOR DOOR
WANDPROFIL FÜR TÜRSEITE
PROFIL DE MUR COTE PORTE*

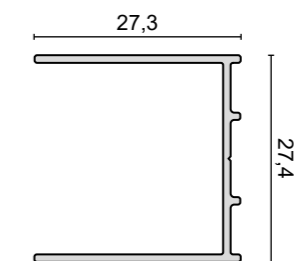

PROFILO A MURO LATO FISSO
*WALL PROFILE SIDE PANEL
WANDPROFIL FÜR SEITENWAND
PROFIL DE MUR LATÉRAL FIXE*

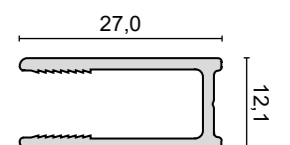

TRATTAMENTO ANTICALCARE

Descaling
Entkalkungsbehandlung
Traitement anticalcaire



MURANO

CRISTALLO TRASPARENTE
TRANSPARENT CRYSTAL
TRANSPARENTES KRISTALLGLAS
VERRE TRANSPARENT

6 mm

BATTENTE PIVOT

| CODICE <i>Code - Artikel - Article</i> | Formato (cm) <i>Size - Format - Dimension</i> | Estensibilità <i>Extensibility - Streckbarkeit - Extensibilité</i> | Prezzo unitario <i>Price - Preis - Prix</i> | E <i>cm</i> | Ingombro porta <i>Door space Tür-Raumbedarf Passage</i> | Lato porta <i>Door - Tür - Porte</i> |
|--|---|--|---|-----------------------|---|--|
| LPBM 9026 | 90 | 87 ÷ 90 | 502,00 | 54,0 | 54,0 | • |
| LPBM 10026 | 100 | 97 ÷ 100 | 521,00 | 59,0 | 59,0 | • |
| LPBM 11026 | 110 | 107 ÷ 110 | 545,00 | 59,0 | 59,0 | • |
| LPBM 12026 | 120 | 117 ÷ 120 | 569,00 | 59,0 | 59,0 | • |
| LPBM 13026 | 130 | 127 ÷ 130 | 593,00 | 59,0 | 59,0 | • |
| LPBM 14026 | 140 | 137 ÷ 140 | 616,00 | 59,0 | 59,0 | • |

Parete fissa - Pezzi da ordinare
*Side - Necessary pieces
Seite - Notwendige Stücke
Paroi fixe - Paroi à commander*

| | | | | |
|-------------------|----|-----------|--------|----------|
| LPMTF 7016 | 70 | 67,5 ÷ 69 | 270,00 | 2 |
| LPMTF 7516 | 75 | 72,5 ÷ 74 | 292,00 | 2 |
| LPMTF 8016 | 80 | 77,5 ÷ 79 | 293,00 | 2 |
| LPMTF 9016 | 90 | 87,5 ÷ 89 | 316,00 | 2 |

PROFILO MAGGIORE ESTENSIBILITÀ PER LATO FISSO

*Wall profile adjustment for side - Verlängerungsprofil für Seitenwand
Profilé pour extension supplémentaire de la paroi fixe*

| Codice - Code <i>Artikel - Article</i> | Formato (cm) - Size <i>Format - Dimension</i> | + cm. | Prezzo (€) - Price <i>Preis - Prix</i> |
|--|---|--------------|--|
| MTP 29 | 4,6 x 200 | 1,5 | 55,00 |

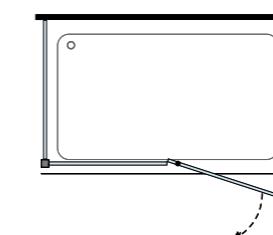
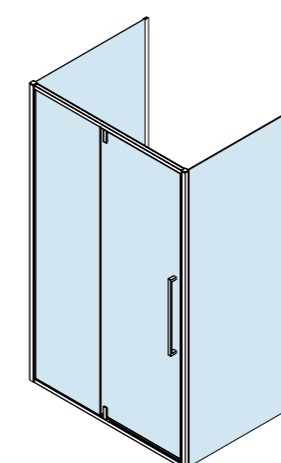
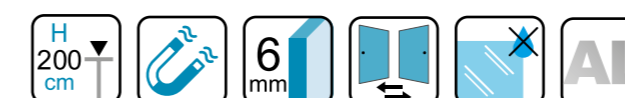

PROFILO A MURO LATO FISSO
*WALL PROFILE SIDE PANEL
WANDPROFIL FÜR SEITENWAND
PROFIL DE MUR LATÉRAL FIXE*

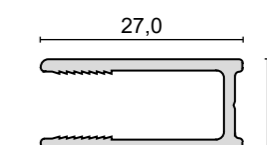

TRATTAMENTO ANTICALCARE

Descaling
Entkalkungsbehandlung
Traitement anticalcaire



MURANO BT

PROFILO NERO SATINATO - CRISTALLO TRASPARENTE

BLACK SATIN PROFILE - TRANSPARENT CRYSTAL
SCHWARZ-SATINIERTES PROFIL - TRANSPARENTES KRISTALLGLAS
PROFILÉ NOIR SATINÉ - VERRE TRANSPARENT

6 mm

BATTENTE PIVOT

| CODICE <i>Code - Artikel - Article</i> | Formato (cm) <i>Size - Format - Dimension</i> | Estensibilità <i>Extensibility - Streckbarkeit - Extensibilité</i> | Prezzo unitario <i>Price - Preis - Prix</i> | E cm | Ingombro porta <i>Door space Tür-Raumbedarf Passage</i> | Lato porta <i>Door - Tür - Porte</i> |
|---|--|---|--|----------------|--|---|
| LPBM 9026BT | 90 | 87 ÷ 90 | 502,00 | 54,0 | 54,0 | • |
| LPBM 10026BT | 100 | 97 ÷ 100 | 521,00 | 59,0 | 59,0 | • |
| LPBM 11026BT | 110 | 107 ÷ 110 | 545,00 | 59,0 | 59,0 | • |
| LPBM 12026BT | 120 | 117 ÷ 120 | 569,00 | 59,0 | 59,0 | • |
| LPBM 13026BT | 130 | 127 ÷ 130 | 593,00 | 59,0 | 59,0 | • |
| LPBM 14026BT | 140 | 137 ÷ 140 | 616,00 | 59,0 | 59,0 | • |

PROFILO MAGGIORE ESTENSIBILITÀ

Wall profile adjustment - Verlängerungsprofil - Profilé pour extension supplémentaire

| Codice - Code Artikel - Article | Formato (cm) - Size Format - Dimension | + cm. | Prezzo (€) - Price Preis - Prix |
|------------------------------------|---|-------|------------------------------------|
| MTP 28B | 4,2 x 200 | 1,5 | 55,00 |

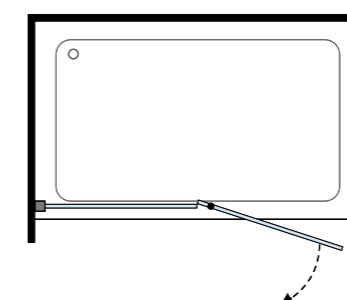
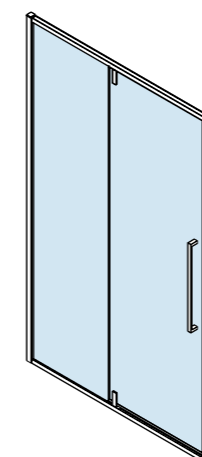
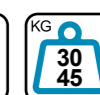

PROFILO A MURO LATO PORTA
WALL PROFILE FOR DOOR
WANDPROFIL FÜR TÜRSEITE
PROFIL DE MUR COTE PORTE

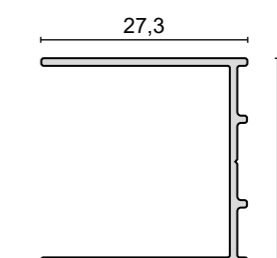

TRATTAMENTO
ANTICALCARE

Descaling
Entkalkungsbehandlung
Traitement anticalcaire



MURANO BT

PROFILO NERO SATINATO - CRISTALLO TRASPARENTE

BLACK SATIN PROFILE - TRANSPARENT CRYSTAL
SCHWARZ-SATINIERTES PROFIL - TRANSPARENTES KRISTALLGLAS
PROFILÉ NOIR SATINÉ - VERRRE TRANSPARENT

6
mm

BATTENTE
PIVOT

| CODICE <i>Code - Artikel - Article</i> | Formato (cm) <i>Size - Format - Dimension</i> | Estensibilità <i>Extensibility - Streckbarkeit - Extensibilité</i> | Prezzo unitario <i>Price - Preis - Prix</i> | E <i>cm</i> | Ingombro porta <i>Door space Tür-Raumbedarf Passage</i> | Lato porta <i>Door - Tür - Porte</i> |
|---|--|---|--|-----------------------|--|---|
| LPBM 9026BT | 90 | 87 ÷ 90 | 502,00 | 54,0 | 54,0 | • |
| LPBM 10026BT | 100 | 97 ÷ 100 | 521,00 | 59,0 | 59,0 | • |
| LPBM 11026BT | 110 | 107 ÷ 110 | 545,00 | 59,0 | 59,0 | • |
| LPBM 12026BT | 120 | 117 ÷ 120 | 569,00 | 59,0 | 59,0 | • |
| LPBM 13026BT | 130 | 127 ÷ 130 | 593,00 | 59,0 | 59,0 | • |
| LPBM 14026BT | 140 | 137 ÷ 140 | 616,00 | 59,0 | 59,0 | • |

Parete fissa - Pezzi da ordinare
*Side - Necessary pieces
Seite - Notwendige Stücke
Paroi fixe - Panoi à commander*

| | | | | |
|--------------|----|-----------|--------|---|
| LPMTF 7016BT | 70 | 67,5 ÷ 69 | 270,00 | 1 |
| LPMTF 7516BT | 75 | 72,5 ÷ 74 | 291,00 | 1 |
| LPMTF 8016BT | 80 | 77,5 ÷ 79 | 293,00 | 1 |
| LPMTF 9016BT | 90 | 87,5 ÷ 89 | 316,00 | 1 |

PROFILO MAGGIORE ESTENSIBILITÀ PER LATO PORTA

Wall profile adjustment for door - Verlängerungsprofil für Türseite
Profilé pour extension supplémentaire de la porte

| Codice - Code Artikel - Article | Formato (cm) - Size Format - Dimension | + cm. | Prezzo (€) - Price Preis - Prix |
|------------------------------------|---|-------|------------------------------------|
| MTP 28B | 4,2 x 200 | 1,5 | 55,00 |

PROFILO MAGGIORE ESTENSIBILITÀ PER LATO FISSO

Wall profile adjustment for side - Verlängerungsprofil für Seitenwand
Profilé pour extension supplémentaire de la paroi fixe

| Codice - Code Artikel - Article | Formato (cm) - Size Format - Dimension | + cm. | Prezzo (€) - Price Preis - Prix |
|------------------------------------|---|-------|------------------------------------|
| MTP 29B | 4,6 x 200 | 1,5 | 55,00 |

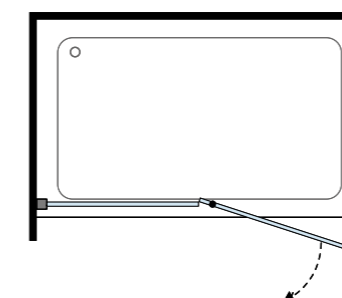
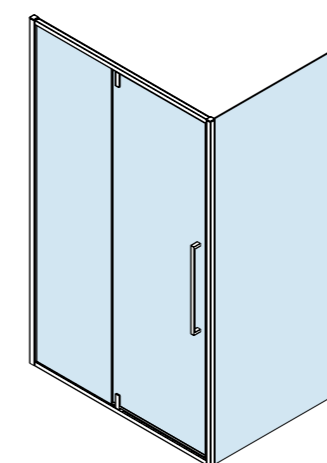
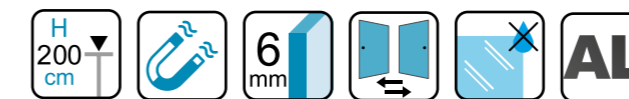

PROFILO A MURO LATO PORTA
WALL PROFILE FOR DOOR
WANDPROFIL FÜR TÜRSEITE
PROFIL DE MUR COTE PORTE

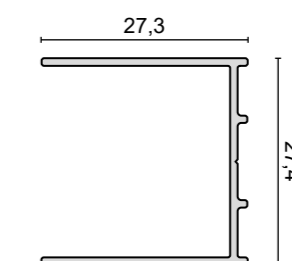

PROFILO A MURO LATO FISSO
WALL PROFILE SIDE PANEL
WANDPROFIL FÜR SEITENWAND
PROFIL DE MUR LATÉRAL FIXE

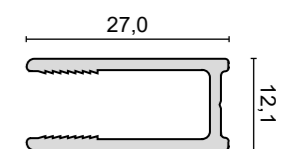

TRATTAMENTO ANTICALCARE

Descaling
Entkalkungsbehandlung
Traitement anticalcaire



MURANO BT

PROFILO NERO SATINATO - CRISTALLO TRASPARENTE

BLACK SATIN PROFILE - TRANSPARENT CRYSTAL
SCHWARZ-SATINIERTES PROFIL - TRANSPARENTES KRISTALLGLAS
PROFILÉ NOIR SATINÉ - VERRE TRANSPARENT

6 mm

BATTENTE PIVOT

| CODICE <i>Code - Artikel - Article</i> | Formato (cm) <i>Size - Format - Dimension</i> | Estensibilità <i>Extensibility - Streckbarkeit - Extensibilité</i> | Prezzo unitario <i>Price - Preis - Prix</i> | E <i>cm</i> | Ingombro porta <i>Door space Tür-Raumbedarf Passage</i> | Lato porta <i>Door - Tür - Porte</i> |
|---|--|---|--|-----------------------|--|---|
| LPBM 9026BT | 90 | 87 ÷ 90 | 502,00 | 54,0 | 54,0 | • |
| LPBM 10026BT | 100 | 97 ÷ 100 | 521,00 | 59,0 | 59,0 | • |
| LPBM 11026BT | 110 | 107 ÷ 110 | 545,00 | 59,0 | 59,0 | • |
| LPBM 12026BT | 120 | 117 ÷ 120 | 569,00 | 59,0 | 59,0 | • |
| LPBM 13026BT | 130 | 127 ÷ 130 | 593,00 | 59,0 | 59,0 | • |
| LPBM 14026BT | 140 | 137 ÷ 140 | 616,00 | 59,0 | 59,0 | • |

Parete fissa - Pezzi da ordinare
*Side - Necessary pieces
Seite - Notwendige Stücke
Paroi fixe - Paroi à commander*

| | | | | |
|--------------|----|-----------|--------|---|
| LPMTF 7016BT | 70 | 67,5 ÷ 69 | 270,00 | 2 |
| LPMTF 7516BT | 75 | 72,5 ÷ 74 | 292,00 | 2 |
| LPMTF 8016BT | 80 | 77,5 ÷ 79 | 293,00 | 2 |
| LPMTF 9016BT | 90 | 87,5 ÷ 89 | 316,00 | 2 |

PROFILO MAGGIORE ESTENSIBILITÀ PER LATO FISSO

*Wall profile adjustment for side - Verlängerungsprofil für Seitenwand
Profilé pour extension supplémentaire de la paroi fixe*

| Codice - Code Artikel - Article | Formato (cm) - Size Format - Dimension | + cm. | Prezzo (€) - Price Preis - Prix |
|------------------------------------|---|-------|------------------------------------|
| MTP 29B | 4,6 x 200 | 1,5 | 55,00 |

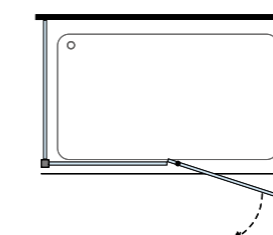
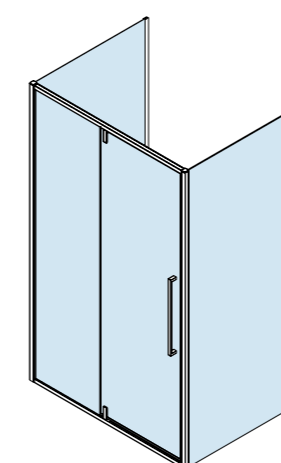

PROFILO A MURO LATO FISSO
*WALL PROFILE SIDE PANEL
WANDPROFIL FÜR SEITENWAND
PROFIL DE MUR LATÉRAL FIXE*

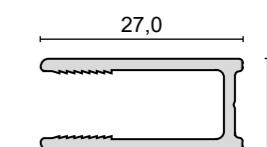

TRATTAMENTO ANTICALCARE

Descaling
Entkalkungsbehandlung
Traitement anticalcaire



MURANO WHITE

PROFILO BIANCO SATINATO - CRISTALLO TRASPARENTE

WHITE SATIN PROFILE - TRANSPARENT CRYSTAL
WEISS-SATINIERTES PROFIL - TRANSPARENTES KRISTALLGLAS
PROFILÉ BLANC SATINÉ - VERRRE TRANSPARENT

6 mm

BATTENTE
PIVOT

| CODICE <i>Code - Artikel - Article</i> | Formato (cm) <i>Size - Format - Dimension</i> | Estensibilità <i>Extensibility - Streckbarkeit - Extensibilité</i> | Prezzo unitario <i>Price - Preis - Prix</i> | E <i>cm</i> | Ingombro porta <i>Door space Tür-Raumbedarf Passage</i> | Lato porta <i>Door - Tür - Porte</i> |
|---|--|---|--|-----------------------|--|---|
| LPBM 9026W | 90 | 87 ÷ 90 | 502,00 | 54,0 | 54,0 | • |
| LPBM 10026W | 100 | 97 ÷ 100 | 521,00 | 59,0 | 59,0 | • |
| LPBM 11026W | 110 | 107 ÷ 110 | 545,00 | 59,0 | 59,0 | • |
| LPBM 12026W | 120 | 117 ÷ 120 | 569,00 | 59,0 | 59,0 | • |
| LPBM 13026W | 130 | 127 ÷ 130 | 593,00 | 59,0 | 59,0 | • |
| LPBM 14026W | 140 | 137 ÷ 140 | 616,00 | 59,0 | 59,0 | • |

PROFILO MAGGIORE ESTENSIBILITÀ

Wall profile adjustment - Verlängerungsprofil - Profilé pour extension supplémentaire

| Codice - Code Artikel - Article | Formato (cm) - Size Format - Dimension | + cm. | Prezzo (€) - Price Preis - Prix |
|------------------------------------|---|-------|------------------------------------|
| MTP 28W | 4,2 x 200 | 1,5 | 55,00 |

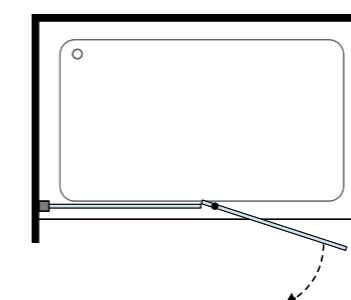
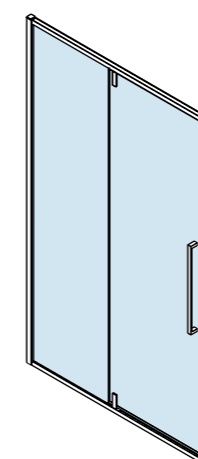

PROFILO A MURO LATO PORTA
WALL PROFILE FOR DOOR
WANDPROFIL FÜR TÜRSEITE
PROFIL DE MUR COTE PORTE

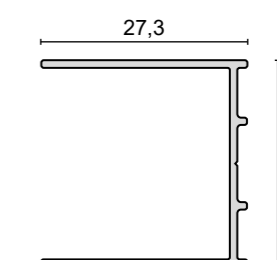

TRATTAMENTO
ANTICALCARE

Descaling
Entkalkungsbehandlung
Traitement anticalcaire



MURANO WHITE

PROFILO BIANCO SATINATO - CRISTALLO TRASPARENTE

WHITE SATIN PROFILE - TRANSPARENT CRYSTAL
WEISS-SATINIERTES PROFIL - TRANSPARENTES KRISTALLGLAS
PROFILÉ BLANC SATINÉ - VERRRE TRANSPARENT

6
mm

BATTENTE
PIVOT

| CODICE <i>Code - Artikel - Article</i> | Formato (cm) <i>Size - Format - Dimension</i> | Estensibilità <i>Extensibility - Streckbarkeit - Extensibilité</i> | Prezzo unitario <i>Price - Preis - Prix</i> | E <i>cm</i> | Ingombro porta <i>Door space Tür-Raumbedarf Passage</i> | Lato porta <i>Door - Tür - Porte</i> |
|---|--|---|--|-----------------------|--|---|
| LPBM 9026W | 90 | 87 ÷ 90 | 502,00 | 54,0 | 54,0 | • |
| LPBM 10026W | 100 | 97 ÷ 100 | 521,00 | 59,0 | 59,0 | • |
| LPBM 11026W | 110 | 107 ÷ 110 | 545,00 | 59,0 | 59,0 | • |
| LPBM 12026W | 120 | 117 ÷ 120 | 569,00 | 59,0 | 59,0 | • |
| LPBM 13026W | 130 | 127 ÷ 130 | 593,00 | 59,0 | 59,0 | • |
| LPBM 14026W | 140 | 137 ÷ 140 | 616,00 | 59,0 | 59,0 | • |

Parete fissa - Pezzi da ordinare
*Side - Necessary pieces
Seite - Notwendige Stücke
Paroi fixe - Paroi à commander*

| | | | | |
|-------------|----|-----------|--------|---|
| LPMTF 7016W | 70 | 67,5 ÷ 69 | 270,00 | 1 |
| LPMTF 7516W | 75 | 72,5 ÷ 74 | 291,00 | 1 |
| LPMTF 8016W | 80 | 77,5 ÷ 79 | 293,00 | 1 |
| LPMTF 9016W | 90 | 87,5 ÷ 89 | 316,00 | 1 |

PROFILO MAGGIORE ESTENSIBILITÀ PER LATO PORTA

Wall profile adjustment for door - Verlängerungsprofil für Türseite
Profilé pour extension supplémentaire de la porte

| Codice - Code Artikel - Article | Formato (cm) - Size Format - Dimension | + cm. | Prezzo (€) - Price Preis - Prix |
|------------------------------------|---|-------|------------------------------------|
| MTP 28W | 4,2 x 200 | 1,5 | 55,00 |

PROFILO MAGGIORE ESTENSIBILITÀ PER LATO FISSO

Wall profile adjustment for side - Verlängerungsprofil für Seitenwand
Profilé pour extension supplémentaire de la paroi fixe

| Codice - Code Artikel - Article | Formato (cm) - Size Format - Dimension | + cm. | Prezzo (€) - Price Preis - Prix |
|------------------------------------|---|-------|------------------------------------|
| MTP 29W | 4,6 x 200 | 1,5 | 55,00 |

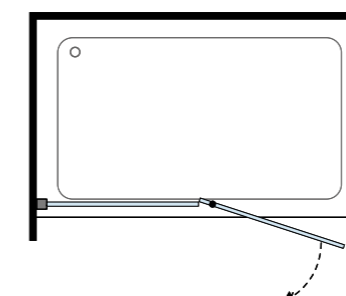
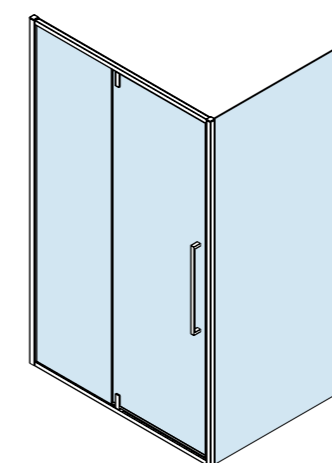

PROFILO A MURO LATO PORTA
WALL PROFILE FOR DOOR
WANDPROFIL FÜR TÜRSEITE
PROFIL DE MUR COTE PORTE

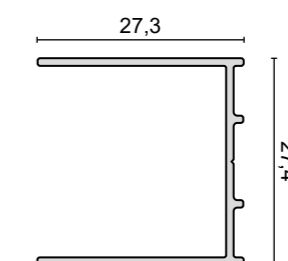

PROFILO A MURO LATO FISSO
WALL PROFILE SIDE PANEL
WANDPROFIL FÜR SEITENWAND
PROFIL DE MUR LATERAL FIXE

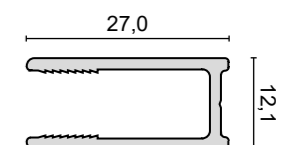

TRATTAMENTO ANTICALCARE

Descaling
Entkalkungsbehandlung
Traitement anticalcaire

MURANO WHITE

PROFILO BIANCO SATINATO - CRISTALLO TRASPARENTE

WHITE SATIN PROFILE - TRANSPARENT CRYSTAL
WEISS-SATINIERTES PROFIL - TRANSPARENTES KRISTALLGLAS
PROFILÉ BLANC SATINÉ - VERRRE TRANSPARENT

6 mm

BATTENTE PIVOT

| CODICE <i>Code - Artikel - Article</i> | Formato (cm) <i>Size - Format - Dimension</i> | Estensibilità <i>Extensibility - Streckbarkeit - Extensibilité</i> | Prezzo unitario <i>Price - Preis - Prix</i> | E <i>cm</i> | Ingombro porta <i>Door space Tür-Raumbedarf Passage</i> | Lato porta <i>Door - Tür - Porte</i> |
|---|--|---|--|-----------------------|--|---|
| LPBM 9026W | 90 | 87 ÷ 90 | 502,00 | 54,0 | 54,0 | • |
| LPBM 10026W | 100 | 97 ÷ 100 | 521,00 | 59,0 | 59,0 | • |
| LPBM 11026W | 110 | 107 ÷ 110 | 545,00 | 59,0 | 59,0 | • |
| LPBM 12026W | 120 | 117 ÷ 120 | 569,00 | 59,0 | 59,0 | • |
| LPBM 13026W | 130 | 127 ÷ 130 | 593,00 | 59,0 | 59,0 | • |
| LPBM 14026W | 140 | 137 ÷ 140 | 616,00 | 59,0 | 59,0 | • |

Parete fissa - Pezzi da ordinare
*Side - Necessary pieces
Seite - Notwendige Stücke
Paroi fixe - Paroi à commander*

| | | | | |
|-------------|----|-----------|--------|---|
| LPMTF 7016W | 70 | 67,5 ÷ 69 | 270,00 | 2 |
| LPMTF 7516W | 75 | 72,5 ÷ 74 | 292,00 | 2 |
| LPMTF 8016W | 80 | 77,5 ÷ 79 | 293,00 | 2 |
| LPMTF 9016W | 90 | 87,5 ÷ 89 | 316,00 | 2 |

PROFILO MAGGIORE ESTENSIBILITÀ PER LATO FISSO

*Wall profile adjustment for side - Verlängerungsprofil für Seitenwand
Profilé pour extension supplémentaire de la paroi fixe*

| Codice - Code Artikel - Article | Formato (cm) - Size Format - Dimension | + cm. | Prezzo (€) - Price Preis - Prix |
|------------------------------------|---|-------|------------------------------------|
| MTP 29W | 4,6 x 200 | 1,5 | 55,00 |

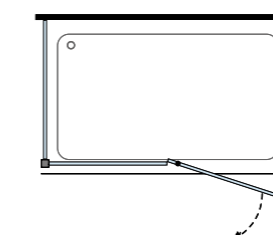
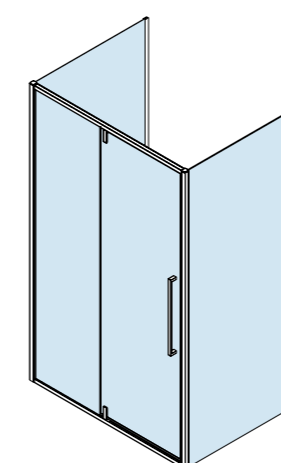
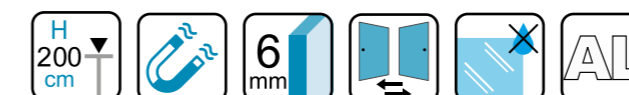

PROFILO A MURO LATO FISSO
*WALL PROFILE SIDE PANEL
WANDPROFIL FÜR SEITENWAND
PROFIL DE MUR LATÉRAL FIXE*

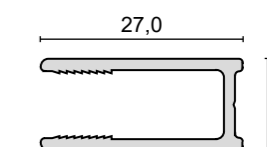

GRADO / MURANO

LACUS RIVESTE... SU MISURA - LACUS MAKES IT... TO MEASURE - LACUS FERTIG ...MASSGERECHT - LACUS UNE FABRICATION SUR ...MESURE

Articoli speciali su ordinazione - Special Items on request - Sonderanfertigungen auf Bestellung - Articles 'à la carte' sur commande

| | | |
|---|----------------------------------|---|
| LATO FISSO - FIXED PANEL FESTE SEITENWAND - PANNEAU FIXE | LATO PORTA DOOR - TÜR - PORTE | VETRO SOPRA MURETTO - GLASS ON THE WALL GLAS AN DER WAND - PAROI SUR MURET |
|---|----------------------------------|---|



| PREZZO DI LISTINO AL PEZZO (TRASPARENTE) GROSS PREIS PRO PIECE (TRANSPARENT) LISTENPREIS PRO STÜCK (TRANSPARENT) PRIX TARIF PAR PIÉCE (TRANSPARENT) | PREVENTIVO SU RICHIESTA PRICE ON REQUEST ANGEBOT AUF ANFRAGE DEVIS SUR DEMANDE | PREVENTIVO SU RICHIESTA PRICE ON REQUEST ANGEBOT AUF ANFRAGE DEVIS SUR DEMANDE |
|--|---|---|
| FASCIA 1: da 0,01 a 0,50 mq Level 1: from 0.01 to 0.5 sqm € 396,00 | GRADO | GRADO NON DISPONIBILE UNAVAILABLE NICHT VERFÜGBAR PAS DISPONIBLE |
| FASCIA 2: da 0,51 a 1,00 mq Level 2: from 0.51 to 1.0 sqm € 476,00 | | |
| FASCIA 3: da 1,01 a 1,50 mq Level 3: from 1.01 to 1.5 sqm € 572,00 | | |
| FASCIA 4: da 1,51 a 2,00 mq Level 4: from 1.51 to 2.0 sqm € 655,00 | MURANO | MURANO |
| FASCIA 5: da 2,01 a 2,50 mq Level 5: from 2.01 to 2.5 sqm € 738,00 | | |
| FASCIA 6: da 2,51 a 3,00 mq Level 5: from 2.51 to 3.0 sqm € 846,00 | | |

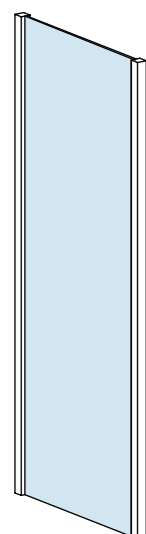

Maggiorazione per vetro Matt, Fox e Gray: +15%
Surcharge for matt, fox and grey crystal + 15%
Aufpreis für Matt, Fox und Grey Kristallglas +15%
Majoration pour les verres Matt, Fox et Grey: +15%

ATTENZIONE:

CALCOLARE I MQ. DEL PEZZO PER STABILIRE LA FASCIA DI APPARTENENZA
Per soluzioni diverse da quelle contemplate contattare ns. ufficio tecnico per avere indicazioni di fattibilità e prezzi.

VORSICHT:

BERECHNEN DIE QM. DES STÜCKES, ZUR ERFÜLLUNG DER ZUGEHÖRIGEN BAND
Für andere als die in Betracht gezogenen Lösungen wenden Sie sich an unser technisches Büro, um Informationen zu Machbarkeit und Preisen zu erhalten.

ATTENTION:

CALCULATE THE SQM OF THE ARTIKEL TO ESTABLISH THE BELONGING LEVEL.
For information on feasibility and prices of other solutions, please get in touch with our technical dept.

ATTENTION:

CALCULER LES M². DE LA PAROI POUR ÉTABLIR LA TRANCHE D'APPARTENANCE
Pour d'autres solutions que celles envisagées, contactez notre bureau technique pour connaître la faisabilité et les tarifs.

DETTAGLI & CARATTERISTICHE

6 mm

BATTENTE
PIVOT

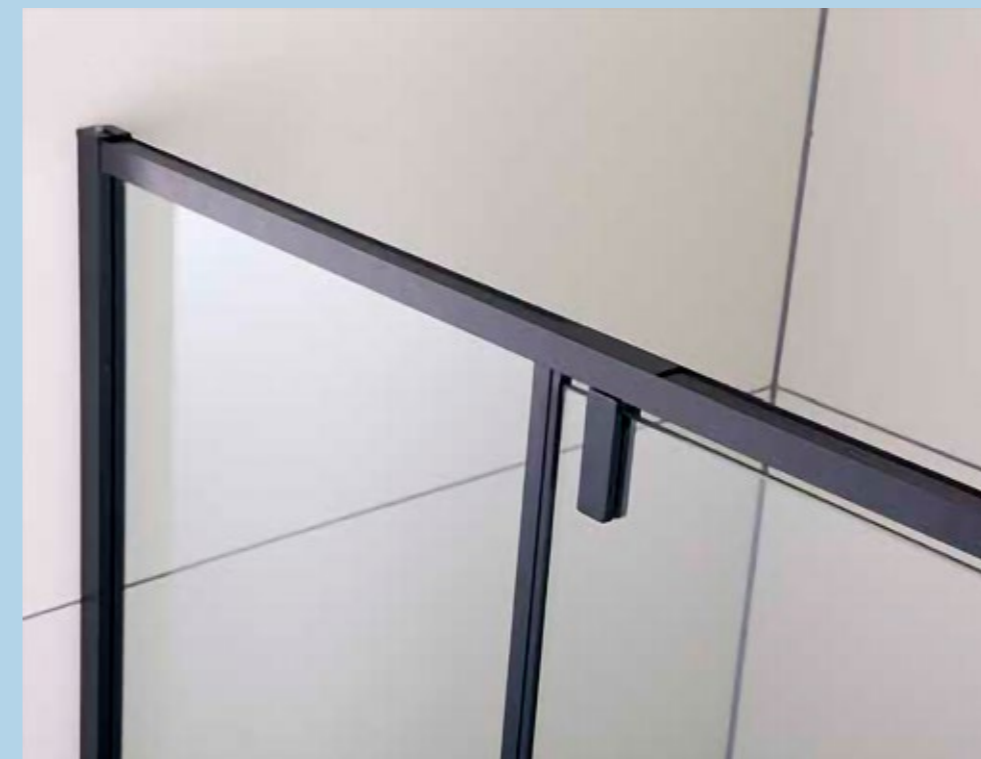

PROFILO SUPERIORE
TOP PROFILE - OBERES PROFIL - PROFILÉ SUPÉRIEUR



MANIGLIA
HANDLE - GRIFF - POIGNÉE



BORDO DEL PROFILO INFERIORE - BOTTOM PROFILE
UNTERES PROFIL - PROFILÉ INFÉRIEUR

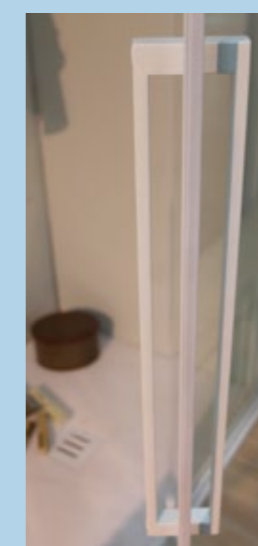

MANIGLIA WHITE
WHITE HANDLE - WEISS GRIFF
POIGNÉE BLANCHE



COPRIPROFILO SUPERIORE
TOP COVER - ABDECKKAPPE FÜR PROFIL
COUVERCLE DE PROFILÉ

CARATTERISTICHE GENERALI

- Cristallo temperato da 6 mm.
- Finitura trasparente.
- Profilo in alluminio cromo lucido, laccato nero satinato e bianco satinato.
- Chiusura magnetica delle ante.
- Chiusura ad anta battente.
- Estensione da 1,5 cm.
- Maniglie e cerniere in zama.

GENERAL FEATURES

- 6 mm tempered safety crystal.
- Transparent crystal.
- Polished aluminum and black and white satin profile.
- Magnetic waterproof closure.
- Outwards opening.
- Extension 1,5 cm.
- Handles and hinges made of zinc alloy.

ALLGEMEINE SPEZIFIKATIONEN

- Sekuritkristallglas 6 mm stark.
- Kristallglasfinish: Transparent.
- Poliertes Chrom- und Schwarz- oder Weiß-satiniertes Profil.
- Wasserdichtes.
- Magnetverschluss der Türen.
- Drehtür.
- Streckbarkeit 1,5 cm.
- Griff und Scharnier aus Zamak.

SPECIFICATIONS GENERALES

- Verre trempé 6 mm.
- Finition du verre: transparent.
- Profilé en aluminium chromé, blanc et noir satiné.
- Portes à fermeture magnétique.
- Ouverture pivotante.
- Extensibilité de 1,5 cm.
- Poignées et charnières en zamak.

TRATTAMENTO ANTICALCARE

Descaling
Entkalkungsbehandlung
Traitement anticalcaire

CRISTALLO TRASPARENTE
TRANSPARENT CRYSTAL
TRANSPARENTES KRISTALLGLAS
VERRE TRANSPARENT

PIANOSA EVO

6 mm

BATTENTE PIVOT



| CODICE <i>Code - Artikel - Article</i> | Formato (cm) <i>Size - Format - Dimension</i> | Estensibilità <i>Extensibility - Streckbarkeit - Extensibilité</i> | Prezzo (€) <i>Price - Preis - Prix</i> | E <i>cm</i> | Ingombro porta <i>Door space Tür-Raumbedarf Passage</i> | Lato porta <i>Door - Tür - Porte</i> |
|--|---|--|--|-----------------------|---|--|
| LFD3 75 | 75 | 74 ÷ 82 | 625,00 | 45 | 43 | • |
| LFD3 85 | 85 | 82 ÷ 90 | 655,00 | 53 | 51 | • |
| LFD3 90 | 90 | 90 ÷ 98 | 690,00 | 53 | 51 | • |
| LFD3 100 | 100 | 98 ÷ 106 | 724,00 | 61 | 59 | • |
| LFD3 110 | 110 | 106 ÷ 114 | 732,00 | 61 | 59 | • |
| LFD3 120 | 120 | 114 ÷ 122 | 752,00 | 61 | 59 | • |
| LFD3 130 | 130 | 122 ÷ 130 | 773,00 | 61 | 59 | • |
| LFD3 140 | 140 | 132 ÷ 140 | 804,00 | 61 | 59 | • |
| LFD3 150 | 150 | 142 ÷ 150 | 869,00 | 61 | 59 | • |
| LFD3 160 | 160 | 152 ÷ 160 | 899,00 | 61 | 59 | • |

Profilo maggiore estensibilità

Wall profile adjustment - Verlängerungsprofil - Profilé pour extension supplémentaire

| Codice - Code <i>Artikel - Article</i> | Formato (cm) - Size <i>Format - Dimension</i> | + cm. | Prezzo (€) - Price <i>Preis - Prix</i> |
|--|---|--------------|--|
| MTP 31 | 4,2 x 200 | 1,5 | 88,00 |

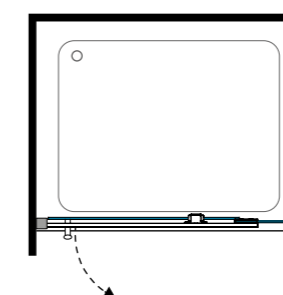
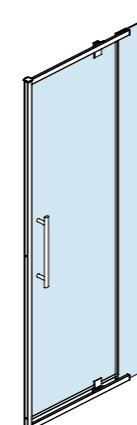
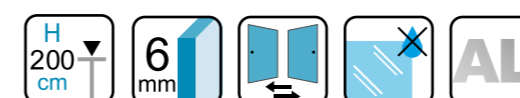

PROFILO A MURO WALL PROFILE - WANDPROFIL - PROFIL DE MUR

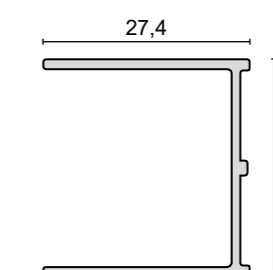

TRATTAMENTO ANTICALCARE

Descaling
Entkalkungsbehandlung
Traitement anticalcaire

PIANOSA EVO

CRISTALLO TRASPARENTE
TRANSPARENT CRYSTAL
TRANSPARENTES KRISTALLVERRE TRANSPARENT

6 mm

BATTENTE PIVOT

| CODICE <i>Code - Artikel - Article</i> | Formato (cm) <i>Size - Format - Dimension</i> | Estensibilità <i>Extensibility - Streckbarkeit - Extensibilité</i> | Prezzo (€) <i>Price - Preis - Prix</i> | E <i>cm</i> | Ingombro porta <i>Door space Tür-Raumbedarf Passage</i> | Lato porta <i>Door - Tür - Porte</i> |
|--|---|--|--|-----------------------|---|--|
| LFD3 75 | 75 | 74 ÷ 82 | 625,00 | 45 | 43 | • |
| LFD3 85 | 85 | 82 ÷ 90 | 655,00 | 53 | 51 | • |
| LFD3 90 | 90 | 90 ÷ 98 | 690,00 | 53 | 51 | • |
| LFD3 100 | 100 | 98 ÷ 106 | 724,00 | 61 | 59 | • |
| LFD3 110 | 110 | 106 ÷ 114 | 732,00 | 61 | 59 | • |
| LFD3 120 | 120 | 114 ÷ 122 | 752,00 | 61 | 59 | • |
| LFD3 130 | 130 | 122 ÷ 130 | 773,00 | 61 | 59 | • |
| LFD3 140 | 140 | 132 ÷ 140 | 804,00 | 61 | 59 | • |
| LFD3 150 | 150 | 142 ÷ 150 | 869,00 | 61 | 59 | • |
| LFD3 160 | 160 | 152 ÷ 160 | 899,00 | 61 | 59 | • |

Parete fissa - Pezzi da ordinare
*Side - Necessary pieces
Seite - Notwendige Stücke
Paroi fixe - Paroi à commander*

| | | | | |
|---------------|-----|-----------|--------|----------|
| LPF3 6516 QI | 65 | 62,5 ÷ 64 | 303,00 | 1 |
| LPF3 7016 QI | 70 | 67,5 ÷ 69 | 316,00 | 1 |
| LPF3 7516 QI | 75 | 72,5 ÷ 74 | 336,00 | 1 |
| LPF3 8016 QI | 80 | 77,5 ÷ 79 | 344,00 | 1 |
| LPF3 9016 QI | 90 | 87,5 ÷ 89 | 372,00 | 1 |
| LPF3 10016 QI | 100 | 97,5 ÷ 99 | 436,00 | 1 |

Profilo maggiore estensibilità

Wall profile adjustment - Verlängerungsprofil - Profilé pour extension supplémentaire

| Codice - Code <i>Artikel - Article</i> | Formato (cm) - Size <i>Format - Dimension</i> | + cm. | Prezzo (€) - Price <i>Preis - Prix</i> |
|--|---|--------------|--|
| MTP 31 | 4,2 x 200 | 1,5 | 88,00 |

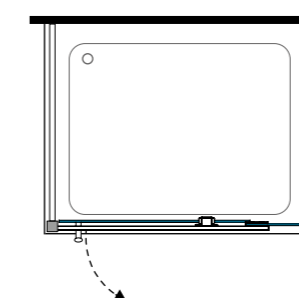
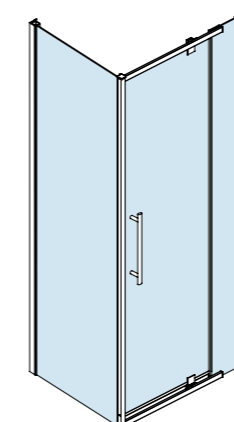
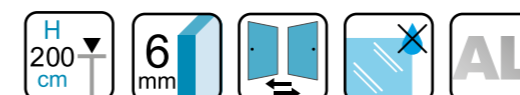

PROFILO A MURO WALL PROFILE - WANDPROFIL - PROFIL DE MUR

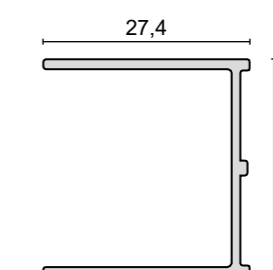

TRATTAMENTO ANTICALCARE

Descaling
Entkalkungsbehandlung
Traitement anticalcaire



PIANOSA EVO

CRISTALLO TRASPARENTE
TRANSPARENT CRYSTAL
TRANSPARENTES KRISTALLGLAS
VERRE TRANSPARENT

6 mm

BATTENTE PIVOT

| CODICE <i>Code - Artikel - Article</i> | Formato (cm) <i>Size - Format - Dimension</i> | Estensibilità <i>Extensibility - Streckbarkeit - Extensibilité</i> | Prezzo (€) <i>Price - Preis - Prix</i> | E <i>cm</i> | Ingombro porta <i>Door space Tür-Raumbedarf Passage</i> | Lato porta <i>Door - Tür - Porte</i> |
|--|---|--|--|-----------------------|---|--|
| LFD3 75 | 75 | 74 ÷ 82 | 625,00 | 45 | 43 | • |
| LFD3 85 | 85 | 82 ÷ 90 | 655,00 | 53 | 51 | • |
| LFD3 90 | 90 | 90 ÷ 98 | 690,00 | 53 | 51 | • |
| LFD3 100 | 100 | 98 ÷ 106 | 724,00 | 61 | 59 | • |
| LFD3 110 | 110 | 106 ÷ 114 | 732,00 | 61 | 59 | • |
| LFD3 120 | 120 | 114 ÷ 122 | 752,00 | 61 | 59 | • |
| LFD3 130 | 130 | 122 ÷ 130 | 773,00 | 61 | 59 | • |
| LFD3 140 | 140 | 132 ÷ 140 | 804,00 | 61 | 59 | • |
| LFD3 150 | 150 | 142 ÷ 150 | 869,00 | 61 | 59 | • |
| LFD3 160 | 160 | 152 ÷ 160 | 899,00 | 61 | 59 | • |

Parete fissa - Pezzi da ordinare
*Side - Necessary pieces
Seite - Notwendige Stücke
Paroi fixe - Paroi à commander*

| | | | | |
|---------------|-----|-----------|--------|---|
| LPF3 6516 QI | 65 | 62,5 ÷ 64 | 303,00 | 2 |
| LPF3 7016 QI | 70 | 67,5 ÷ 69 | 316,00 | 2 |
| LPF3 7516 QI | 75 | 72,5 ÷ 74 | 336,00 | 2 |
| LPF3 8016 QI | 80 | 77,5 ÷ 79 | 344,00 | 2 |
| LPF3 9016 QI | 90 | 87,5 ÷ 89 | 372,00 | 2 |
| LPF3 10016 QI | 100 | 97,5 ÷ 99 | 436,00 | 2 |

Profilo maggiore estensibilità

Wall profile adjustment - Verlängerungsprofil - Profilé pour extension supplémentaire

| Codice - Code <i>Artikel - Article</i> | Formato (cm) - Size <i>Format - Dimension</i> | + cm. | Prezzo (€) - Price <i>Preis - Prix</i> |
|--|---|--------------|--|
| MTP 31 | 4,2 x 200 | 1,5 | 88,00 |

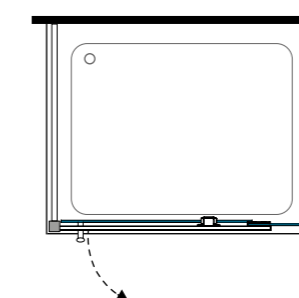
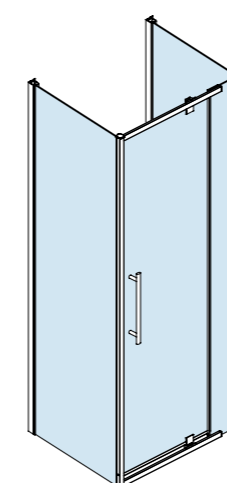
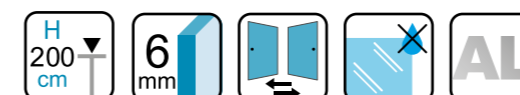

PROFILO A MURO WALL PROFILE - WANDPROFIL - PROFIL DE MUR

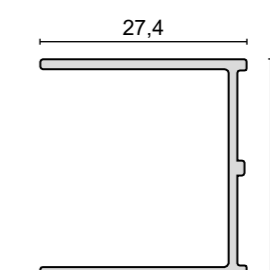

PIANOSA EVO

LACUS RIVESTE... SU MISURA - LACUS MAKES IT... TO MEASURE - LACUS FERTIG ...MASSGERECHT - LACUS UNE FABRICATION SUR ...MESURE

Articoli speciali su ordinazione - Special Items on request - Sonderanfertigungen auf Bestellung - Articles 'à la carte' sur commande

| | | |
|---|----------------------------------|---|
| LATO FISSO - FIXED PANEL FESTE SEITENWAND - PANNEAU FIXE | LATO PORTA DOOR - TÜR - PORTE | VETRO SOPRA MURETTO - GLASS ON THE WALL GLAS AN DER WAND - PAROI SUR MURET |
|---|----------------------------------|---|

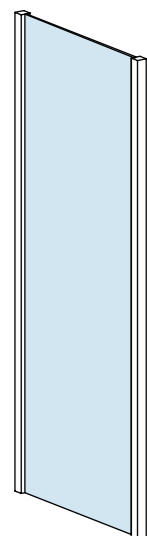

| PREZZO DI LISTINO AL PEZZO (TRASPARENTE) GROSS PREIS PRO PIECE (TRANSPARENT) LISTENPREIS PRO STÜCK (TRANSPARENT) PRIX TARIF PAR PIÈCE (TRANSPARENT) | PREVENTIVO SU RICHIESTA PRICE ON REQUEST ANGEBOT AUF ANFRAGE DEVIS SUR DEMANDE | PREVENTIVO SU RICHIESTA PRICE ON REQUEST ANGEBOT AUF ANFRAGE DEVIS SUR DEMANDE |
|--|---|---|
|--|---|---|

| | | |
|--|---|----------|
|  | FASCIA 1: da 0,01 a 0,50 mq Level 1: from 0.01 to 0.5 sqm | € 526,00 |
| | FASCIA 2: da 0,51 a 1,00 mq Level 2: from 0.51 to 1.0 sqm | € 606,00 |
| | FASCIA 3: da 1,01 a 1,50 mq Level 3: from 1.01 to 1.5 sqm | € 702,00 |
| | FASCIA 4: da 1,51 a 2,00 mq Level 4: from 1.51 to 2.0 sqm | € 785,00 |
| | FASCIA 5: da 2,01 a 2,50 mq Level 5: from 2.01 to 2.5 sqm | € 868,00 |
| | FASCIA 6: da 2,51 a 3,00 mq Level 6: from 2.51 to 3.0 sqm | € 976,00 |

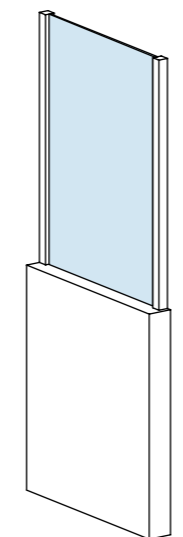
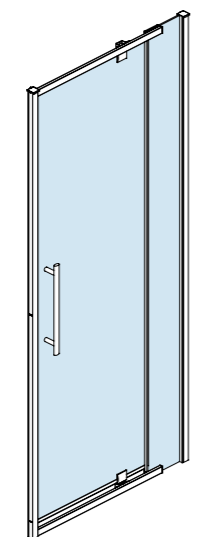

Maggiorazione per vetro Matt, Fox e Gray: +15%
Surcharge for matt, fox and grey crystal + 15%
Aufpreis für Matt, Fox und Grey Kristallglas +15%
Majoration pour les verres Matt, Fox et Grey: +15%

ATTENZIONE:
CALCOLARE I MQ. DEL PEZZO PER STABILIRE LA FASCIA DI APPARTENENZA
Per soluzioni diverse da quelle contemplate contattare ns. ufficio tecnico per avere indicazioni di fattibilità e prezzi.
VORSICHT:
BERECHNEN DIE QM. DES STÜCKES, ZUR ERFÜLLUNG DER ZUGEHÖRIGEN BAND
Für andere als die in Betracht gezogenen Lösungen wenden Sie sich an unser technisches Büro, um Informationen zu Machbarkeit und Preisen zu erhalten.

ATTENTION:
CALCULATE THE SQM OF THE ARTIKEL TO ESTABLISH THE BELONGING LEVEL.
For information on feasibility and prices of other solutions, please get in touch with our technical dept.
ATTENTION:
CALCULER LES M². DE LA PAROI POUR ÉTABLIR LA TRANCHÉ D'APPARTENANCE
Pour d'autres solutions que celles envisagées, contactez notre bureau technique pour connaître la faisabilité et les tarifs.

DETTAGLI & CARATTERISTICHE

6 mm
BATTENTE
PIVOT

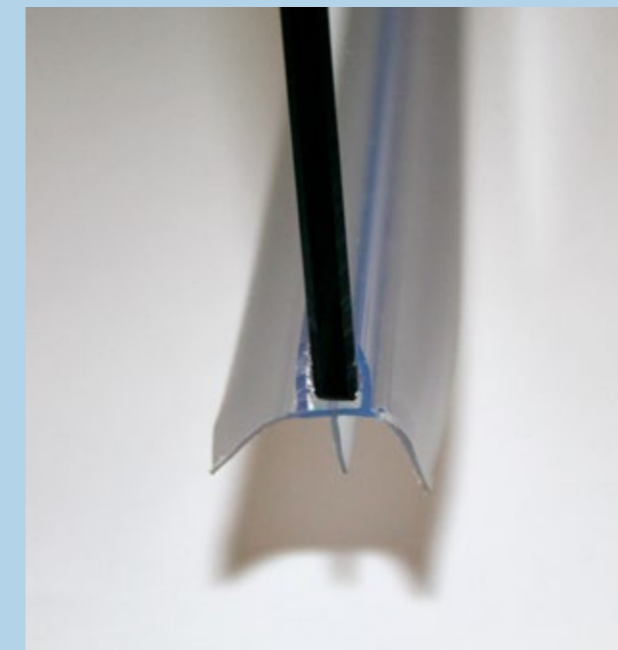

GUARNIZIONE INFERIORE CON ALETTE
BOTTOM GASKET - UNTERE DICHTUNG
JOINT INFÉRIEURE



CERNIERA SUPERIORE
TOP HINGE - TED OBERE SCHARNIER
CHARNIÈRE SUPERIEUR



MANIGLIA
HANDLE - GRIFF - POIGNÉE

CARATTERISTICHE GENERALI

- Cristallo temperato da 6 mm.
- Finitura trasparente.
- Profilo in alluminio cromo lucido.
- Chiusura magnetica delle ante.
- Chiusura ad anta battente.
- Estensione da 2 a 10 cm.
- Maniglia in acciaio e cerniere in zama.

GENERAL FEATURES

- 6 mm tempered safety crystal.
- Transparent crystal.
- Polished aluminum profile.
- Magnetic waterproof closure.
- Outwards opening.
- Extension from 2 to 10 cm.
- Handle made of stainless steel and Hinge made of zinc alloy.

ALLGEMEINE SPEZIFIKATIONEN

- Sekurirkristallglas 6 mm stark.
- Kristallglasfinish: Transparent.
- Poliertes Chrom Profil.
- Magnetverschluss der Türen.
- Drehtür.
- Streckbarkeit von 2 bis 10 cm.
- Griff aus Rostfreie und Scharnier aus Zamak.

SPECIFICATIONS GENERALES

- Verre trempé 6 mm.
- Finition du verre: transparent.
- Profilé en aluminium chromé.
- Portes à fermeture magnétique.
- Ouverture pivotante.
- Extensibilité de 2 à 10 cm.
- Poignée en acier et charnière en zamak.

MONTECRISTO

CRISTALLO TRASPARENTE
 TRANSPARENT CRYSTAL
 TRANSPARENTES KRISTALLGLAS
 VERRE TRANSPARENT

6 mm

BATTENTE
 PIVOT

| CODICE <i>Code - Artikel - Article</i> | Formato (cm) <i>Size - Format - Dimension</i> | Estensibilità <i>Extensibility - Streckbarkeit - Extensibilité</i> | Prezzo (€) <i>Price - Preis - Prix</i> | E <i>cm</i> | Ingombro porta <i>Door space Tür-Raumbedarf Passage</i> | Lato porta <i>Door - Tür - Porte</i> |
|--|---|--|--|-----------------------|---|--|
| LPBFN EVO 9026 | 70 + 20 | 86 ÷ 90 | 703,00 | 60,0 | 60,0 | • |
| LPBFN EVO 9526 | 75 + 20 | 91 ÷ 95 | 712,00 | 65,0 | 65,0 | • |
| LPBFN EVO 10026 | 80 + 20 | 96 ÷ 100 | 722,00 | 70,0 | 70,0 | • |
| LPBFN EVO 10526 | 75 + 30 | 101 ÷ 105 | 733,00 | 65,0 | 65,0 | • |
| LPBFN EVO 11026 | 80 + 30 | 106 ÷ 110 | 744,00 | 70,0 | 70,0 | • |
| LPBFN EVO 11526 | 75 + 40 | 111 ÷ 115 | 755,00 | 65,0 | 65,0 | • |
| LPBFN EVO 12026 | 80 + 40 | 116 ÷ 120 | 764,00 | 70,0 | 70,0 | • |
| LPBFN EVO 13026 | 90 + 40 | 126 ÷ 130 | 787,00 | 80,0 | 80,0 | • |
| LPBFN EVO 14026 | 100 + 40 | 136 ÷ 140 | 807,00 | 90,0 | 90,0 | • |

Profilo maggiore estensibilità

Wall profile adjustment - Verlängerungsprofil - Profilé pour extension supplémentaire

| Codice - Code <i>Artikel - Article</i> | Formato (cm) - Size <i>Format - Dimension</i> | + cm. | Prezzo (€) - Price <i>Preis - Prix</i> |
|--|---|--------------|--|
| MTP 03E | 5,4 x 190 | 2,0 | 65,00 |

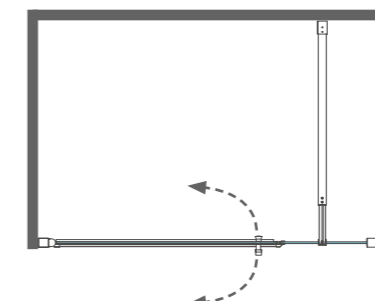
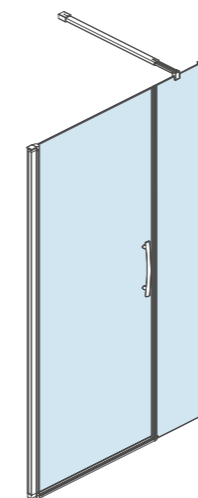
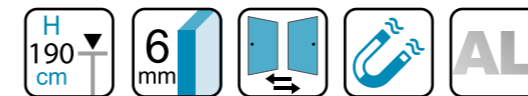

PROFILO A MURO WALL PROFILE - WANDPROFIL - PROFIL DE MUR

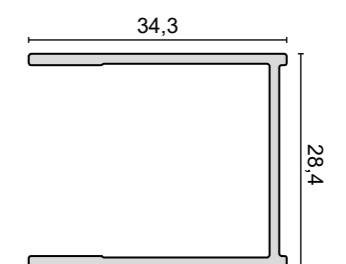



MONTECRISTO

CRISTALLO TRASPARENTE
 TRANSPARENT CRYSTAL
 TRANSPARENTES KRISTALLGLAS
 VERRE TRANSPARENT

6 mm

**BATTENTE
PIVOT**

| CODICE <i>Code - Artikel - Article</i> | Formato (cm) <i>Size - Format - Dimension</i> | Estensibilità <i>Extensibility - Streckbarkeit - Extensibilité</i> | Prezzo (€) <i>Price - Preis - Prix</i> | E <i>cm</i> | Ingombro porta <i>Door space Tür-Raumbedarf Passage</i> | Lato porta <i>Door - Tür - Porte</i> |
|--|---|--|--|-----------------------|---|--|
| LPBFN EVO 9026 | 70 + 20 | 86 ÷ 90 | 703,00 | 60,0 | 60,0 | • |
| LPBFN EVO 9526 | 75 + 20 | 91 ÷ 95 | 712,00 | 65,0 | 65,0 | • |
| LPBFN EVO 10026 | 80 + 20 | 96 ÷ 100 | 722,00 | 70,0 | 70,0 | • |
| LPBFN EVO 10526 | 75 + 30 | 101 ÷ 105 | 733,00 | 65,0 | 65,0 | • |
| LPBFN EVO 11026 | 80 + 30 | 106 ÷ 110 | 744,00 | 70,0 | 70,0 | • |
| LPBFN EVO 11526 | 75 + 40 | 111 ÷ 115 | 755,00 | 65,0 | 65,0 | • |
| LPBFN EVO 12026 | 80 + 40 | 116 ÷ 120 | 764,00 | 70,0 | 70,0 | • |
| LPBFN EVO 13026 | 90 + 40 | 126 ÷ 130 | 787,00 | 80,0 | 80,0 | • |
| LPBFN EVO 14026 | 100 + 40 | 136 ÷ 140 | 807,00 | 90,0 | 90,0 | • |

Parete fissa - Pezzi da ordinare
*Side - Necessary pieces
 Seite - Notwendige Stücke
 Paroi fixe - Paroi à commander*

| | | | | |
|----------------|-----|---------|--------|----------|
| LPB EVO 17016 | 70 | 67 ÷ 69 | 415,00 | 1 |
| LPB EVO 17516 | 75 | 72 ÷ 74 | 424,00 | 1 |
| LPB EVO 18016 | 80 | 77 ÷ 79 | 432,00 | 1 |
| LPB EVO 18516 | 85 | 82 ÷ 84 | 448,00 | 1 |
| LPB EVO 19016 | 90 | 87 ÷ 89 | 451,00 | 1 |
| LPB EVO 110016 | 100 | 97 ÷ 99 | 494,00 | 1 |

Profilo maggiore estensibilità

Wall profile adjustment - Verlängerungsprofil - Profilé pour extension supplémentaire

| Codice - Code <i>Artikel - Article</i> | Formato (cm) - Size <i>Format - Dimension</i> | + cm. | Prezzo (€) - Price <i>Preis - Prix</i> |
|--|---|--------------|--|
| MTP 03E | 5,4 x 190 | 2,0 | 65,00 |

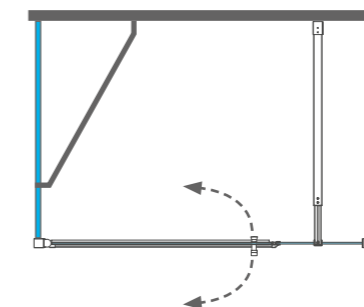
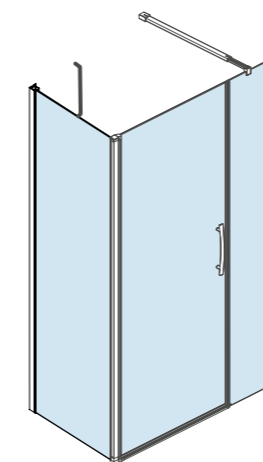
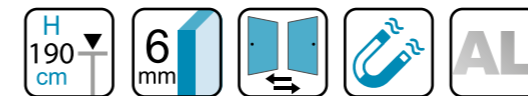

PROFILO A MURO
 WALL PROFILE - WANDPROFIL - PROFIL DE MUR

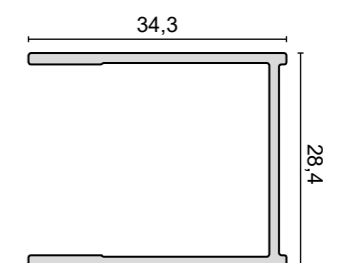

TRATTAMENTO ANTICALCARE

Descaling
Entkalkungsbehandlung
Traitement anticalcaire

GIGLIO EVO

CRISTALLO TRASPARENTE
TRANSPARENT CRYSTAL
TRANSPARENTES KRISTALLGLAS
VERRE TRANSPARENT

6 mm

BATTENTE PIVOT

| CODICE <i>Code - Artikel - Article</i> | Formato (cm) <i>Size - Format - Dimension</i> | Estensibilità <i>Extensibility - Streckbarkeit - Extensibilité</i> | Prezzo (€) <i>Price - Preis - Prix</i> | E <i>cm</i> | Ingombro porta - Door space <i>Tür-Raumbedarf - Passage</i> |
|--|---|--|--|-----------------------|---|
| LPB3 7026 | 70 | 66 ÷ 70 | 653,00 | 54,0 | 27,0 |
| LPB3 7526 | 75 | 71 ÷ 75 | 678,00 | 60,0 | 29,5 |
| LPB3 8026 | 80 | 76 ÷ 80 | 671,00 | 64,0 | 32,0 |
| LPB3 8526 | 85 | 81 ÷ 85 | 684,00 | 70,0 | 34,5 |
| LPB3 9026 | 90 | 86 ÷ 90 | 689,00 | 74,0 | 37,0 |
| LPB3 9526 | 95 | 91 ÷ 95 | 716,00 | 79,0 | 39,5 |
| LPB3 10026 | 100 | 96 ÷ 100 | 718,00 | 84,0 | 42,0 |
| LPB3 10526 | 105 | 101 ÷ 105 | 729,00 | 89,0 | 44,5 |
| LPB3 11026 | 110 | 106 ÷ 110 | 738,00 | 94,0 | 47,0 |
| LPB3 11526 | 115 | 111 ÷ 115 | 748,00 | 99,0 | 49,5 |
| LPB3 12026 | 120 | 116 ÷ 120 | 758,00 | 104,0 | 52,0 |
| LPB3 13026 | 130 | 126 ÷ 130 | 786,00 | 114,0 | 57,0 |
| LPB3 14026 | 140 | 136 ÷ 140 | 807,00 | 124,0 | 62,0 |

Profilo maggiore estensibilità

Wall profile adjustment - Verlängerungsprofil - Profilé pour extension supplémentaire

| Codice - Code <i>Artikel - Article</i> | Formato (cm) - Size <i>Format - Dimension</i> | + cm. | Prezzo (€) - Price <i>Preis - Prix</i> |
|--|---|--------------|--|
| MTP 03F | 5,4 x 200 | 2,0 | 67,00 |

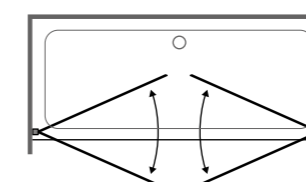
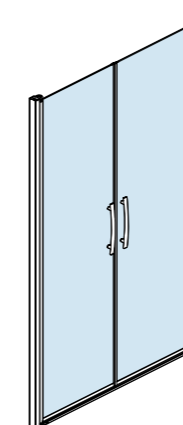
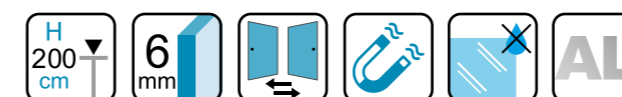

PROFILO A MURO WALL PROFILE - WANDPROFIL - PROFIL DE MUR

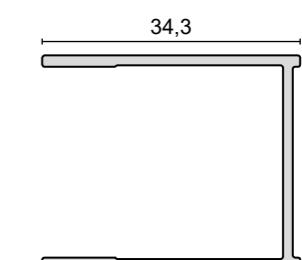

TRATTAMENTO ANTICALCARE

Descaling
Entkalkungsbehandlung
Traitement anticalcaire

GIGLIO EVO

CRISTALLO TRASPARENTE
TRANSPARENT CRYSTAL
TRANSPARENTES KRISTALLGLAS
VERRE TRANSPARENT

6 mm

BATTENTE PIVOT

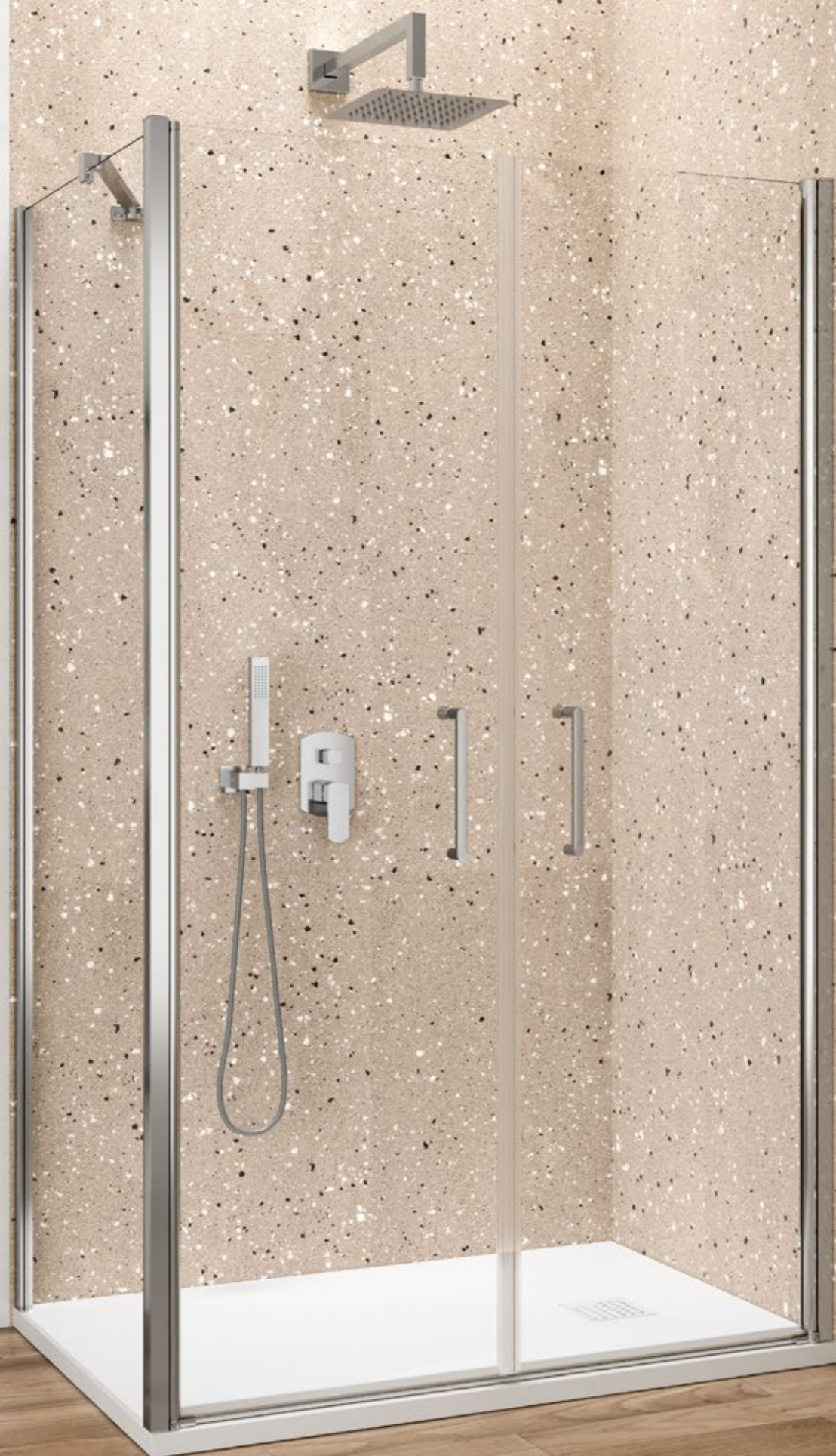

| CODICE <i>Code - Artikel - Article</i> | Formato (cm) <i>Size - Format - Dimension</i> | Estensibilità <i>Extensibility - Streckbarkeit - Extensibilité</i> | Prezzo (€) <i>Price - Preis - Prix</i> | E <i>cm</i> | Ingombro porta <i>Door space Tür-Raumbedarf Passage</i> | Lato porta <i>Door - Tür - Porte</i> |
|--|---|--|--|-----------------------|---|--|
| LPB3 7026 | 70 | 66 ÷ 70 | 653,00 | 54,0 | 27,0 | • |
| LPB3 7526 | 75 | 71 ÷ 75 | 678,00 | 60,0 | 29,5 | • |
| LPB3 8026 | 80 | 76 ÷ 80 | 671,00 | 64,0 | 32,0 | • |
| LPB3 8526 | 85 | 81 ÷ 85 | 684,00 | 70,0 | 34,5 | • |
| LPB3 9026 | 90 | 86 ÷ 90 | 689,00 | 74,0 | 37,0 | • |
| LPB3 9526 | 95 | 91 ÷ 95 | 716,00 | 79,0 | 39,5 | • |
| LPB3 10026 | 100 | 96 ÷ 100 | 718,00 | 84,0 | 42,0 | • |
| LPB3 10526 | 105 | 101 ÷ 105 | 729,00 | 89,0 | 44,5 | • |
| LPB3 11026 | 110 | 106 ÷ 110 | 738,00 | 94,0 | 47,0 | • |
| LPB3 11526 | 115 | 111 ÷ 115 | 748,00 | 99,0 | 49,5 | • |
| LPB3 12026 | 120 | 116 ÷ 120 | 758,00 | 104,0 | 52,0 | • |
| LPB3 13026 | 130 | 126 ÷ 130 | 786,00 | 114,0 | 57,0 | • |
| LPB3 14026 | 140 | 136 ÷ 140 | 807,00 | 124,0 | 62,0 | • |

Parete fissa - Pezzi da ordinare
*Side - Necessary pieces
Seite - Notwendige Stücke
Paroi fixe - Paroi à commander*

| | | | | |
|-------------|-----|---------|--------|---|
| LPB3 17016 | 70 | 67 ÷ 69 | 445,00 | 1 |
| LPB3 17516 | 75 | 72 ÷ 74 | 454,00 | 1 |
| LPB3 18016 | 80 | 77 ÷ 79 | 463,00 | 1 |
| LPB3 18516 | 85 | 82 ÷ 84 | 480,00 | 1 |
| LPB3 19016 | 90 | 87 ÷ 89 | 481,00 | 1 |
| LPB3 110016 | 100 | 97 ÷ 99 | 530,00 | 1 |

Profilo maggiore estensibilità

Wall profile adjustment - Verlängerungsprofil - Profilé pour extension supplémentaire

| Codice - Code <i>Artikel - Article</i> | Formato (cm) - Size <i>Format - Dimension</i> | + cm. | Prezzo (€) - Price <i>Preis - Prix</i> |
|--|---|--------------|--|
| MTP 03F | 5,4 x 200 | 2,0 | 67,00 |

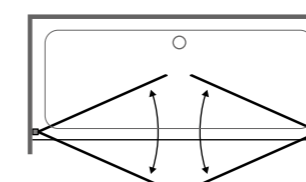
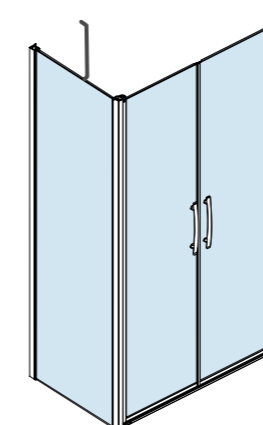
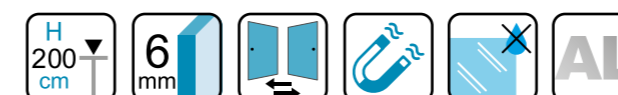

PROFILO A MURO WALL PROFILE - WANDPROFIL - PROFIL DE MUR

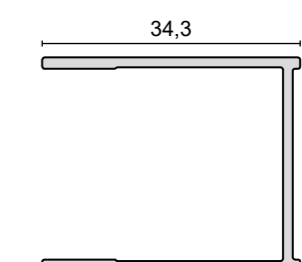

TRATTAMENTO ANTICALCARE

Descaling
Entkalkungsbehandlung
Traitement anticalcaire

GIGLIO EVO

CRISTALLO TRASPARENTE
TRANSPARENT CRYSTAL
TRANSPARENTES KRISTALLGLAS
VERRE TRANSPARENT

6 mm

BATTENTE PIVOT



| CODICE <i>Code - Artikel - Article</i> | Formato (cm) <i>Size - Format - Dimension</i> | Estensibilità <i>Extensibility - Streckbarkeit - Extensibilité</i> | Prezzo (€) <i>Price - Preis - Prix</i> | E <i>cm</i> | Ingombro porta <i>Door space Tür-Raumbedarf Passage</i> | Lato porta <i>Door - Tür - Porte</i> |
|--|---|--|--|-----------------------|---|--|
| LPB3 7026 | 70 | 66 ÷ 70 | 653,00 | 54,0 | 27,0 | • |
| LPB3 7526 | 75 | 71 ÷ 75 | 678,00 | 60,0 | 29,5 | • |
| LPB3 8026 | 80 | 76 ÷ 80 | 671,00 | 64,0 | 32,0 | • |
| LPB3 8526 | 85 | 81 ÷ 85 | 684,00 | 70,0 | 34,5 | • |
| LPB3 9026 | 90 | 86 ÷ 90 | 689,00 | 74,0 | 37,0 | • |
| LPB3 9526 | 95 | 91 ÷ 95 | 716,00 | 79,0 | 39,5 | • |
| LPB3 10026 | 100 | 96 ÷ 100 | 718,00 | 84,0 | 42,0 | • |
| LPB3 10526 | 105 | 101 ÷ 105 | 729,00 | 89,0 | 44,5 | • |
| LPB3 11026 | 110 | 106 ÷ 110 | 738,00 | 94,0 | 47,0 | • |
| LPB3 11526 | 115 | 111 ÷ 115 | 748,00 | 99,0 | 49,5 | • |
| LPB3 12026 | 120 | 116 ÷ 120 | 758,00 | 104,0 | 52,0 | • |
| LPB3 13026 | 130 | 126 ÷ 130 | 786,00 | 114,0 | 57,0 | • |
| LPB3 14026 | 140 | 136 ÷ 140 | 807,00 | 124,0 | 62,0 | • |

Parete fissa - Pezzi da ordinare
*Side - Necessary pieces
Seite - Notwendige Stücke
Paroi fixe - Paroi à commander*

| | | | | |
|-------------|-----|---------|--------|---|
| LPB3 17016 | 70 | 67 ÷ 69 | 445,00 | 2 |
| LPB3 17516 | 75 | 72 ÷ 74 | 454,00 | 2 |
| LPB3 18016 | 80 | 77 ÷ 79 | 463,00 | 2 |
| LPB3 18516 | 85 | 82 ÷ 84 | 480,00 | 2 |
| LPB3 19016 | 90 | 87 ÷ 89 | 481,00 | 2 |
| LPB3 110016 | 100 | 97 ÷ 99 | 530,00 | 2 |

Profilo maggiore estensibilità

Wall profile adjustment - Verlängerungsprofil - Profilé pour extension supplémentaire

| Codice - Code <i>Artikel - Article</i> | Formato (cm) - Size <i>Format - Dimension</i> | + cm. | Prezzo (€) - Price <i>Preis - Prix</i> |
|--|---|--------------|--|
| MTP 03F | 5,4 x 200 | 2,0 | 67,00 |

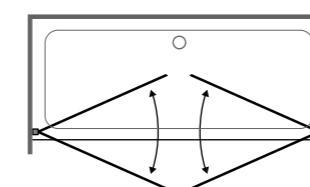
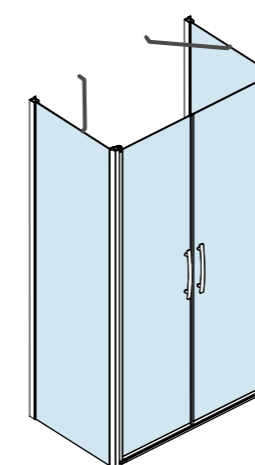
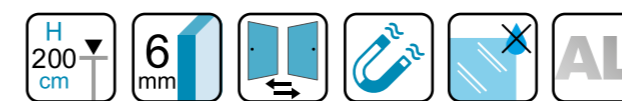

PROFILO A MURO WALL PROFILE - WANDPROFIL - PROFIL DE MUR

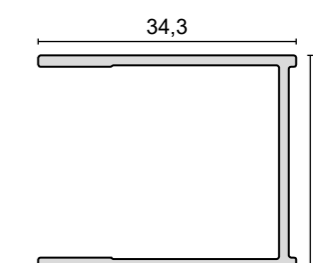

TRATTAMENTO ANTICALCARE

Descaling
Entkalkungsbehandlung
Traitement anticalcaire

GIGLIO EVO BT

6 mm

BATTENTE PIVOT

| CODICE <i>Code - Artikel - Article</i> | Formato (cm) <i>Size - Format - Dimension</i> | Estensibilità <i>Extensibility - Streckbarkeit - Extensibilité</i> | Prezzo (€) <i>Price - Preis - Prix</i> | E <i>cm</i> | Ingombro porta - <i>Door space</i> <i>Tür-Raumbedarf - Passage</i> |
|--|---|--|--|-----------------------|--|
| LPB3 8026BT | 80 | 76 ÷ 80 | 719,00 | 64,0 | 32,0 |
| LPB3 9026BT | 90 | 86 ÷ 90 | 744,00 | 74,0 | 37,0 |
| LPB3 10026BT | 100 | 96 ÷ 100 | 766,00 | 84,0 | 42,0 |
| LPB3 11026BT | 110 | 106 ÷ 110 | 777,00 | 94,0 | 47,0 |
| LPB3 11526BT | 115 | 111 ÷ 115 | 787,00 | 99,0 | 49,5 |
| LPB3 12026BT | 120 | 116 ÷ 120 | 798,00 | 104,0 | 52,0 |
| LPB3 14026BT | 140 | 136 ÷ 140 | 862,00 | 124,0 | 62,0 |

Profilo maggiore estensibilità

Wall profile adjustment - Verlängerungsprofil - Profilé pour extension supplémentaire

| Codice - <i>Code</i> <i>Artikel - Article</i> | Formato (cm) - <i>Size</i> <i>Format - Dimension</i> | + cm. | Prezzo (€) - <i>Price</i> <i>Preis - Prix</i> |
|---|--|--------------|---|
| MTP 03FB | 5,4 x 200 | 2,0 | 70,00 |

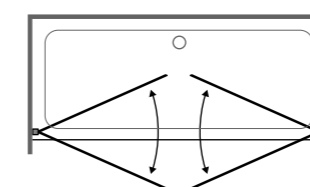
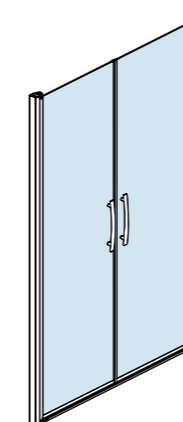
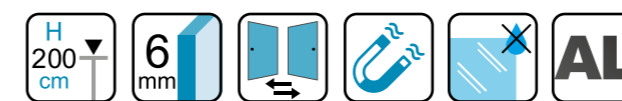

PROFILO A MURO WALL PROFILE - WANDPROFIL - PROFIL DE MUR

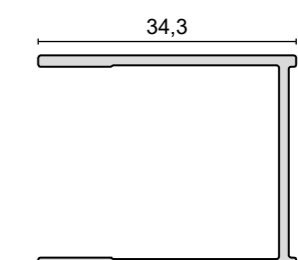

TRATTAMENTO ANTICALCARE

Descaling
Entkalkungsbehandlung
Traitement anticalcaire



GIGLIO EVO BT

6 mm

BATTENTE PIVOT

| CODICE <i>Code - Artikel - Article</i> | Formato (cm) <i>Size - Format - Dimension</i> | Estensibilità <i>Extensibility - Streckbarkeit - Extensibilité</i> | Prezzo (€) <i>Price - Preis - Prix</i> | E <i>cm</i> | Ingombro porta <i>Door space Tür-Raumbedarf Passage</i> | Lato porta <i>Door - Tür - Porte</i> |
|--|---|--|--|-----------------------|---|--|
| LPB3 8026BT | 80 | 76 ÷ 80 | 719,00 | 64,0 | 32,0 | • |
| LPB3 9026BT | 90 | 86 ÷ 90 | 744,00 | 74,0 | 37,0 | • |
| LPB3 10026BT | 100 | 96 ÷ 100 | 766,00 | 84,0 | 42,0 | • |
| LPB3 11026BT | 110 | 106 ÷ 110 | 777,00 | 94,0 | 47,0 | • |
| LPB3 11526BT | 115 | 111 ÷ 115 | 787,00 | 99,0 | 49,5 | • |
| LPB312026BT | 120 | 116 ÷ 120 | 798,00 | 104,0 | 52,0 | • |
| LPB3 14026BT | 140 | 136 ÷ 140 | 862,00 | 124,0 | 62,0 | • |

Parete fissa - Pezzi da ordinare
*Side - Necessary pieces
Seite - Notwendige Stücke
Paroi fixe - Paroi à commander*

| | | | | |
|--------------|----|---------|--------|----------|
| LPB3 17016BT | 70 | 67 ÷ 69 | 449,00 | 1 |
| LPB3 18016BT | 80 | 77 ÷ 79 | 478,00 | 1 |
| LPB3 19016BT | 90 | 87 ÷ 89 | 507,00 | 1 |

Profilo maggiore estensibilità

Wall profile adjustment - Verlängerungsprofil - Profilé pour extension supplémentaire

| Codice - Code <i>Artikel - Article</i> | Formato (cm) - Size <i>Format - Dimension</i> | + cm. | Prezzo (€) - Price <i>Preis - Prix</i> |
|--|---|--------------|--|
| MTP 03FB | 5,4 x 200 | 2,0 | 70,00 |

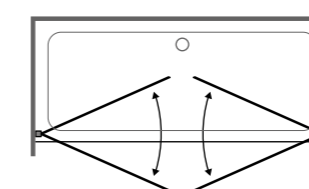
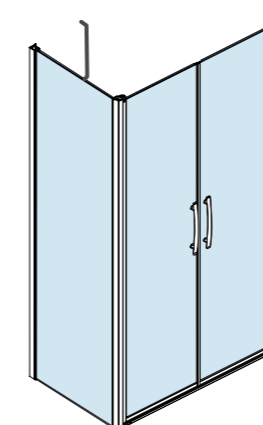
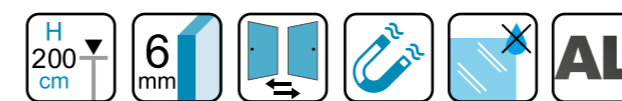

PROFILO A MURO WALL PROFILE - WANDPROFIL - PROFIL DE MUR

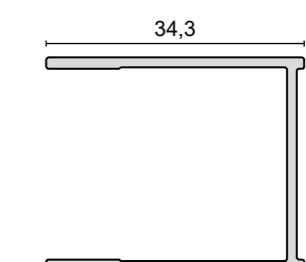

TRATTAMENTO ANTICALCARE

Descaling
Entkalkungsbehandlung
Traitement anticalcaire



GIGLIO EVO BT

6 mm

BATTENTE PIVOT

| CODICE <i>Code - Artikel - Article</i> | Formato (cm) <i>Size - Format - Dimension</i> | Estensibilità <i>Extensibility - Streckbarkeit - Extensibilité</i> | Prezzo (€) <i>Price - Preis - Prix</i> | E <i>cm</i> | Ingombro porta <i>Door space Tür-Raumbedarf Passage</i> | Lato porta <i>Door - Tür - Porte</i> |
|--|---|--|--|-----------------------|---|--|
| LPB3 8026BT | 80 | 76 ÷ 80 | 719,00 | 64,0 | 32,0 | • |
| LPB3 9026BT | 90 | 86 ÷ 90 | 744,00 | 74,0 | 37,0 | • |
| LPB3 10026BT | 100 | 96 ÷ 100 | 766,00 | 84,0 | 42,0 | • |
| LPB3 11026BT | 110 | 106 ÷ 110 | 777,00 | 94,0 | 47,0 | • |
| LPB3 11526BT | 115 | 111 ÷ 115 | 787,00 | 99,0 | 49,5 | • |
| LPB312026BT | 120 | 116 ÷ 120 | 798,00 | 104,0 | 52,0 | • |
| LPB3 14026BT | 140 | 136 ÷ 140 | 862,00 | 124,0 | 62,0 | • |

Parete fissa - Pezzi da ordinare
*Side - Necessary pieces
Seite - Notwendige Stücke
Paroi fixe - Paroi à commander*

| | | | | |
|--------------|----|---------|--------|----------|
| LPB3 17016BT | 70 | 67 ÷ 69 | 449,00 | 2 |
| LPB3 18016BT | 80 | 77 ÷ 79 | 478,00 | 2 |
| LPB3 19016BT | 90 | 87 ÷ 89 | 507,00 | 2 |

Profilo maggiore estensibilità

Wall profile adjustment - Verlängerungsprofil - Profilé pour extension supplémentaire

| Codice - Code <i>Artikel - Article</i> | Formato (cm) - Size <i>Format - Dimension</i> | + cm. | Prezzo (€) - Price <i>Preis - Prix</i> |
|--|---|--------------|--|
| MTP 03FB | 5,4 x 200 | 2,0 | 70,00 |

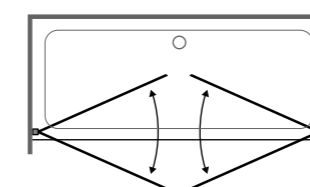
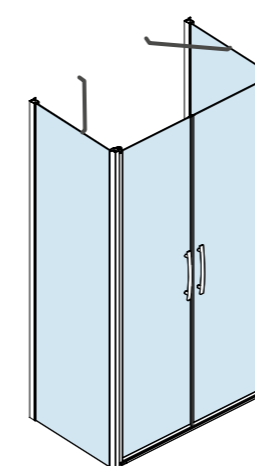
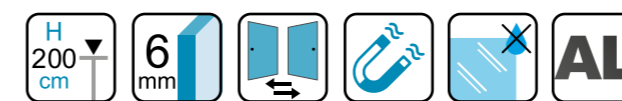

PROFILO A MURO WALL PROFILE - WANDPROFIL - PROFIL DE MUR

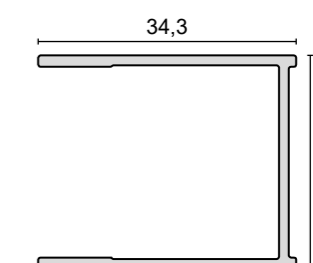

TRATTAMENTO ANTICALCARE

Descaling
Entkalkungsbehandlung
Traitement anticalcaire

GIGLIO EVO BLACK

CRISTALLO GRIGIO / PROFILO NERO SATINATO
GREY CRYSTAL / BLACK SATIN PROFILE
GRAUES KRISTALLGLAS / SCHWARZ-SATINIERTES PROFIL
VERRE FUMÉ / PROFILÉ NOIR SATINÉ

6 mm

BATTENTE PIVOT

| CODICE <i>Code - Artikel - Article</i> | Formato (cm) <i>Size - Format - Dimension</i> | Estensibilità <i>Extensibility - Streckbarkeit - Extensibilité</i> | Prezzo (€) <i>Price - Preis - Prix</i> | E cm | Ingombro porta - Door space <i>Tür-Raumbedarf - Passage</i> |
|---|--|---|---|----------------|--|
| LPB3 8026B | 80 | 76 ÷ 80 | 719,00 | 64,0 | 32,0 |
| LPB3 9026B | 90 | 86 ÷ 90 | 744,00 | 74,0 | 37,0 |
| LPB3 10026B | 100 | 96 ÷ 100 | 766,00 | 84,0 | 42,0 |
| LPB3 11026B | 110 | 106 ÷ 110 | 777,00 | 94,0 | 47,0 |
| LPB3 11526B | 115 | 111 ÷ 115 | 787,00 | 99,0 | 49,5 |
| LPB3 12026B | 120 | 116 ÷ 120 | 798,00 | 104,0 | 52,0 |
| LPB3 14026B | 140 | 136 ÷ 140 | 862,00 | 124,0 | 62,0 |

Profilo maggiore estensibilità

Wall profile adjustment - Verlängerungsprofil - Profilé pour extension supplémentaire

| Codice - Code Artikel - Article | Formato (cm) - Size Format - Dimension | + cm. | Prezzo (€) - Price Preis - Prix |
|------------------------------------|---|-------|------------------------------------|
| MTP 03FB | 5,4 x 200 | 2,0 | 70,00 |

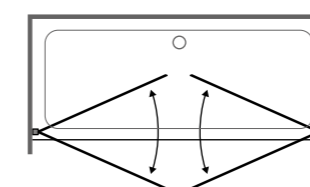
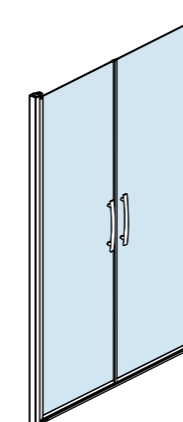
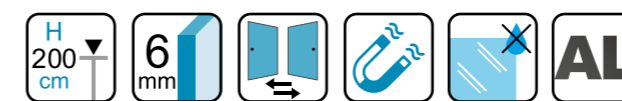

PROFILO A MURO WALL PROFILE - WANDPROFIL - PROFIL DE MUR

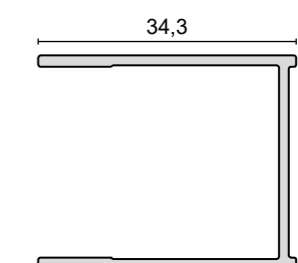

TRATTAMENTO ANTICALCARE

Descaling
Entkalkungsbehandlung
Traitement anticalcaire

GIGLIO EVO BLACK

CRISTALLO GRIGIO / PROFILO NERO SATINATO

GREY CRYSTAL / BLACK SATIN PROFILE
GRAUES KRISTALLGLAS / SCHWARZ-SATINIERTES PROFIL
VERRE FUMÉ / PROFILÉ NOIR SATINÉ

6 mm

BATTENTE PIVOT

| CODICE <i>Code - Artikel - Article</i> | Formato (cm) <i>Size - Format - Dimension</i> | Estensibilità <i>Extensibility - Streckbarkeit - Extensibilité</i> | Prezzo (€) <i>Price - Preis - Prix</i> | E <i>cm</i> | Ingombro porta <i>Door space Tür-Raumbedarf Passage</i> | Lato porta <i>Door - Tür - Porte</i> |
|---|--|---|---|-----------------------|--|---|
| LPB3 8026B | 80 | 76 ÷ 80 | 719,00 | 64,0 | 32,0 | • |
| LPB3 9026B | 90 | 86 ÷ 90 | 744,00 | 74,0 | 37,0 | • |
| LPB3 10026B | 100 | 96 ÷ 100 | 766,00 | 84,0 | 42,0 | • |
| LPB3 11026B | 110 | 106 ÷ 110 | 777,00 | 94,0 | 47,0 | • |
| LPB3 11526B | 115 | 111 ÷ 115 | 787,00 | 99,0 | 49,5 | • |
| LPB3 12026B | 120 | 116 ÷ 120 | 798,00 | 104,0 | 52,0 | • |
| LPB3 14026B | 140 | 136 ÷ 140 | 862,00 | 124,0 | 62,0 | • |

Parete fissa - Pezzi da ordinare
*Side - Necessary pieces
Seite - Notwendige Stücke
Paroi fixe - Paroi à commander*

| | | | | |
|-------------|----|---------|--------|---|
| LPB3 17016B | 70 | 67 ÷ 69 | 449,00 | 1 |
| LPB3 18016B | 80 | 77 ÷ 79 | 478,00 | 1 |
| LPB3 19016B | 90 | 87 ÷ 89 | 507,00 | 1 |

Profilo maggiore estensibilità

Wall profile adjustment - Verlängerungsprofil - Profilé pour extension supplémentaire

| Codice - Code Artikel - Article | Formato (cm) - Size Format - Dimension | + cm. | Prezzo (€) - Price Preis - Prix |
|------------------------------------|---|-------|------------------------------------|
| MTP 03FB | 5,4 x 200 | 2,0 | 70,00 |

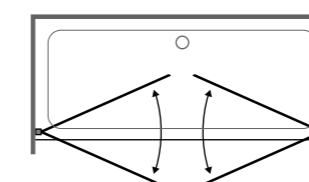
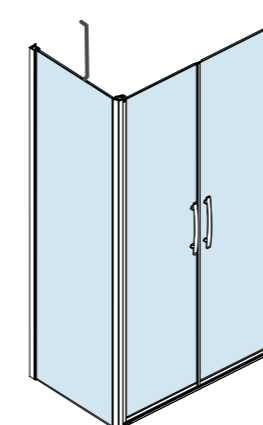
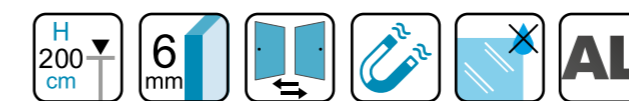

PROFILO A MURO WALL PROFILE - WANDPROFIL - PROFIL DE MUR

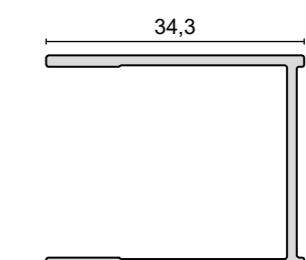

TRATTAMENTO ANTICALCARE

Descaling
Entkalkungsbehandlung
Traitement anticalcaire

GIGLIO EVO BLACK

CRISTALLO GRIGIO / PROFILO NERO SATINATO

GREY CRYSTAL / BLACK SATIN PROFILE
GRAUES KRISTALLGLAS / SCHWARZ-SATINIERTES PROFIL
VERRE FUMÉ / PROFILÉ NOIR SATINÉ

6 mm

BATTENTE PIVOT

| CODICE <i>Code - Artikel - Article</i> | Formato (cm) <i>Size - Format - Dimension</i> | Estensibilità <i>Extensibility - Streckbarkeit - Extensibilité</i> | Prezzo (€) <i>Price - Preis - Prix</i> | E <i>cm</i> | Ingombro porta <i>Door space Tür-Raumbedarf Passage</i> | Lato porta <i>Door - Tür - Porte</i> |
|---|--|---|---|-----------------------|--|---|
| LPB3 8026B | 80 | 76 ÷ 80 | 719,00 | 64,0 | 32,0 | • |
| LPB3 9026B | 90 | 86 ÷ 90 | 744,00 | 74,0 | 37,0 | • |
| LPB3 10026B | 100 | 96 ÷ 100 | 766,00 | 84,0 | 42,0 | • |
| LPB3 11026B | 110 | 106 ÷ 110 | 777,00 | 94,0 | 47,0 | • |
| LPB3 11526B | 115 | 111 ÷ 115 | 787,00 | 99,0 | 49,5 | • |
| LPB3 12026B | 120 | 116 ÷ 120 | 798,00 | 104,0 | 52,0 | • |
| LPB3 14026B | 140 | 136 ÷ 140 | 862,00 | 124,0 | 62,0 | • |

Parete fissa - Pezzi da ordinare
*Side - Necessary pieces
Seite - Notwendige Stücke
Paroi fixe - Paroi à commander*

| | | | | |
|-------------|----|---------|--------|---|
| LPB3 17016B | 70 | 67 ÷ 69 | 449,00 | 2 |
| LPB3 18016B | 80 | 77 ÷ 79 | 478,00 | 2 |
| LPB3 19016B | 90 | 87 ÷ 89 | 507,00 | 2 |

Profilo maggiore estensibilità

Wall profile adjustment - Verlängerungsprofil - Profilé pour extension supplémentaire

| Codice - Code Artikel - Article | Formato (cm) - Size Format - Dimension | + cm. | Prezzo (€) - Price Preis - Prix |
|------------------------------------|---|-------|------------------------------------|
| MTP 03FB | 5,4 x 200 | 2,0 | 70,00 |

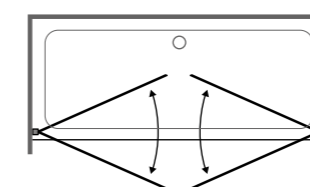
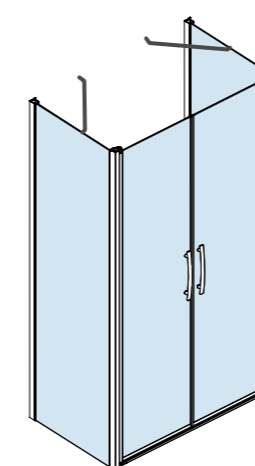
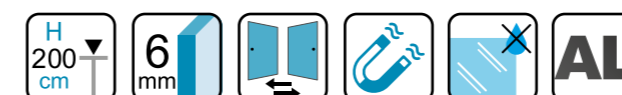

PROFILO A MURO WALL PROFILE - WANDPROFIL - PROFIL DE MUR

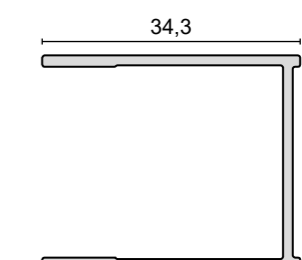

TRATTAMENTO ANTICALCARE

Descaling
Entkalkungsbehandlung
Traitement anticalcaire

GIGLIO EVO FOX

CRISTALLO PIUMATO
FOX CRYSTAL
FOX KRISTALLGLAS
VERRE GRANITÉ

6 mm

BATTENTE PIVOT

| CODICE <i>Code - Artikel - Article</i> | Formato (cm) <i>Size - Format - Dimension</i> | Estensibilità <i>Extensibility - Streckbarkeit - Extensibilité</i> | Prezzo (€) <i>Price - Preis - Prix</i> | E <small>cm</small> | Ingombro porta - Door space <i>Tür-Raumbedarf - Passage</i> |
|---|--|---|---|-------------------------------|--|
| LPB3 7026F | 70 | 66 ÷ 70 | 696,00 | 54,0 | 27,0 |
| LPB3 7526F | 75 | 71 ÷ 75 | 714,00 | 60,0 | 29,5 |
| LPB3 8026F | 80 | 76 ÷ 80 | 720,00 | 64,0 | 32,0 |
| LPB3 8526F | 85 | 81 ÷ 85 | 732,00 | 70,0 | 34,5 |
| LPB3 9026F | 90 | 86 ÷ 90 | 743,00 | 74,0 | 37,0 |
| LPB3 10026F | 100 | 96 ÷ 100 | 778,00 | 84,0 | 42,0 |
| LPB3 11026F | 110 | 106 ÷ 110 | 804,00 | 94,0 | 47,0 |
| LPB3 12026F | 120 | 116 ÷ 120 | 831,00 | 104,0 | 52,0 |
| LPB3 14026F | 140 | 136 ÷ 140 | 875,00 | 124,0 | 62,0 |

Profilo maggiore estensibilità

Wall profile adjustment - Verlängerungsprofil - Profilé pour extension supplémentaire

| Codice - Code Artikel - Article | Formato (cm) - Size Format - Dimension | + cm. | Prezzo (€) - Price Preis - Prix |
|------------------------------------|---|-------|------------------------------------|
| MTP 03F | 5,4 x 200 | 2,0 | 67,00 |

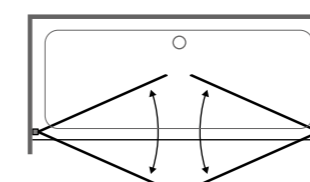
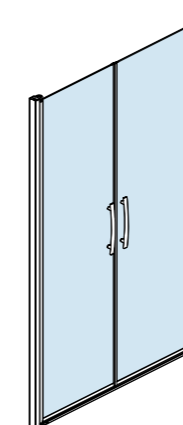
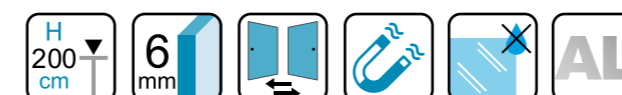

PROFILO A MURO WALL PROFILE - WANDPROFIL - PROFIL DE MUR

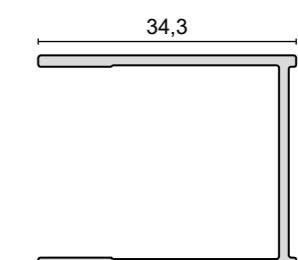

TRATTAMENTO ANTICALCARE

Descaling
Entkalkungsbehandlung
Traitement anticalcaire



GIGLIO EVO FOX

CRISTALLO PIUMATO
FOX CRYSTAL
FOX KRISTALLGLAS
VERRE GRANITÉ

6 mm

BATTENTE PIVOT

| CODICE <i>Code - Artikel - Article</i> | Formato (cm) <i>Size - Format - Dimension</i> | Estensibilità <i>Extensibility - Streckbarkeit - Extensibilité</i> | Prezzo (€) <i>Price - Preis - Prix</i> | E <i>cm</i> | Ingombro porta <i>Door space Tür-Raumbedarf Passage</i> | Lato porta <i>Door - Tür - Porte</i> |
|---|--|---|---|-----------------------|--|---|
| LPB3 7026F | 70 | 66 ÷ 70 | 696,00 | 54,0 | 27,0 | • |
| LPB3 7526F | 75 | 71 ÷ 75 | 714,00 | 60,0 | 29,5 | • |
| LPB3 8026F | 80 | 76 ÷ 80 | 720,00 | 64,0 | 32,0 | • |
| LPB3 8526F | 85 | 81 ÷ 85 | 732,00 | 70,0 | 34,5 | • |
| LPB3 9026F | 90 | 86 ÷ 90 | 743,00 | 74,0 | 37,0 | • |
| LPB3 10026F | 100 | 96 ÷ 100 | 778,00 | 84,0 | 42,0 | • |
| LPB3 11026F | 110 | 106 ÷ 110 | 804,00 | 94,0 | 47,0 | • |
| LPB3 12026F | 120 | 116 ÷ 120 | 831,00 | 104,0 | 52,0 | • |
| LPB3 14026F | 140 | 136 ÷ 140 | 875,00 | 124,0 | 62,0 | • |

Parete fissa - Pezzi da ordinare
*Side - Necessary pieces
Seite - Notwendige Stücke
Paroi fixe - Paroi à commander*

| | | | | |
|-------------|----|---------|--------|---|
| LPB3 17016F | 70 | 67 ÷ 69 | 449,00 | 1 |
| LPB3 17516F | 75 | 72 ÷ 74 | 467,00 | 1 |
| LPB3 18016F | 80 | 77 ÷ 79 | 470,00 | 1 |
| LPB3 19016F | 90 | 87 ÷ 89 | 497,00 | 1 |

Profilo maggiore estensibilità

Wall profile adjustment - Verlängerungsprofil - Profilé pour extension supplémentaire

| Codice - Code Artikel - Article | Formato (cm) - Size Format - Dimension | + cm. | Prezzo (€) - Price Preis - Prix |
|------------------------------------|---|-------|------------------------------------|
| MTP 03F | 5,4 x 200 | 2,0 | 67,00 |

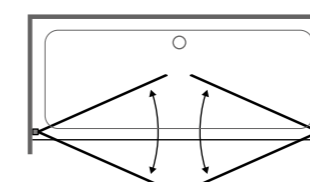
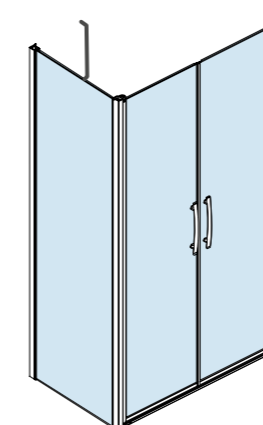
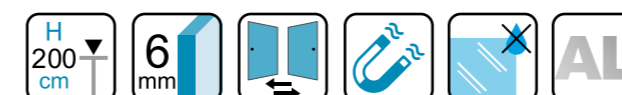

PROFILO A MURO WALL PROFILE - WANDPROFIL - PROFIL DE MUR

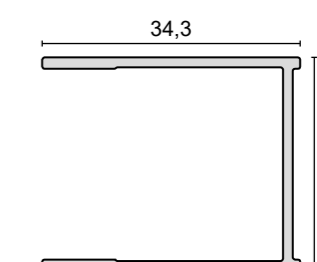

TRATTAMENTO ANTICALCARE

Descaling
Entkalkungsbehandlung
Traitement anticalcaire

CRISTALLO PIUMATO
FOX CRYSTAL
FOX KRISTALLGLAS
VERRE GRANITÉ

6 mm

BATTENTE PIVOT

GIGLIO EVO FOX

| CODICE Code - Artikel - Article | Formato (cm) Size - Format - Dimension | Estensibilità Extensibility - Streckbarkeit - Extensibilité | Prezzo (€) Price - Preis - Prix | E cm | Ingombro porta Door space Tür-Raumbedarf Passage | Lato porta Door - Tür - Porte |
|---|--|---|---|----------------|--|---|
| LPB3 7026F | 70 | 66 ÷ 70 | 696,00 | 54,0 | 27,0 | • |
| LPB3 7526F | 75 | 71 ÷ 75 | 714,00 | 60,0 | 29,5 | • |
| LPB3 8026F | 80 | 76 ÷ 80 | 720,00 | 64,0 | 32,0 | • |
| LPB3 8526F | 85 | 81 ÷ 85 | 732,00 | 70,0 | 34,5 | • |
| LPB3 9026F | 90 | 86 ÷ 90 | 743,00 | 74,0 | 37,0 | • |
| LPB3 10026F | 100 | 96 ÷ 100 | 778,00 | 84,0 | 42,0 | • |
| LPB3 11026F | 110 | 106 ÷ 110 | 804,00 | 94,0 | 47,0 | • |
| LPB3 12026F | 120 | 116 ÷ 120 | 831,00 | 104,0 | 52,0 | • |
| LPB3 14026F | 140 | 136 ÷ 140 | 875,00 | 124,0 | 62,0 | • |

Parete fissa - Pezzi da ordinare
Side - Necessary pieces
Seite - Notwendige Stücke
Paroi fixe - Paroi à commander

| | | | | |
|-------------|----|---------|--------|----------|
| LPB3 17016F | 70 | 67 ÷ 69 | 449,00 | 2 |
| LPB3 1756F | 75 | 72 ÷ 74 | 467,00 | 2 |
| LPB3 18016F | 80 | 77 ÷ 79 | 470,00 | 2 |
| LPB3 19016F | 90 | 87 ÷ 89 | 497,00 | 2 |

Profilo maggiore estensibilità

Wall profile adjustment - Verlängerungsprofil - Profilé pour extension supplémentaire

| Codice - Code Artikel - Article | Formato (cm) - Size Format - Dimension | + cm. | Prezzo (€) - Price Preis - Prix |
|---|--|--------------|---|
| MTP 03F | 5,4 x 200 | 2,0 | 67,00 |

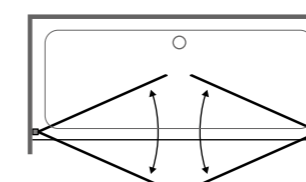
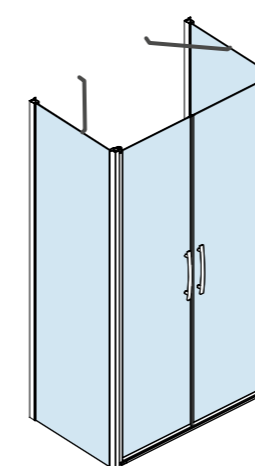
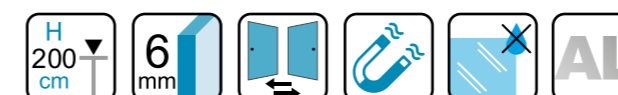

PROFILO A MURO WALL PROFILE - WANDPROFIL - PROFIL DE MUR

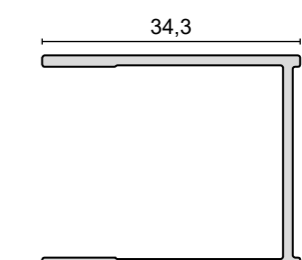

TRATTAMENTO ANTICALCARE

Descaling
Entkalkungsbehandlung
Traitement anticalcaire

GIGLIO EVO

CRISTALLO TRASPARENTE
TRANSPARENT CRYSTAL
TRANSPARENTES KRISTALLGLAS
VERRE TRANSPARENT

6 mm

BATTENTE PIVOT

| CODICE <i>Code - Artikel - Article</i> | Formato (cm) <i>Size - Format - Dimension</i> | Estensibilità <i>Extensibility - Streckbarkeit - Extensibilité</i> | Prezzo (€) <i>Price - Preis - Prix</i> | E <i>cm</i> | Ingombro porta - Door space <i>Tür-Raumbedarf - Passage</i> |
|--|---|--|--|-----------------------|---|
| LPB3 7016 | 70 | 66 ÷ 70 | 560,00 | 56,0 | 56,0 |
| LPB3 7516 | 75 | 71 ÷ 75 | 568,00 | 61,0 | 61,0 |
| LPB3 8016 | 80 | 76 ÷ 80 | 581,00 | 66,0 | 66,0 |
| LPB3 8516 | 85 | 81 ÷ 85 | 598,00 | 71,0 | 71,0 |
| LPB3 9016 | 90 | 86 ÷ 90 | 603,00 | 76,0 | 76,0 |
| LPB3 9516 | 95 | 91 ÷ 95 | 622,00 | 81,0 | 81,0 |
| LPB3 10016 | 100 | 96 ÷ 100 | 624,00 | 86,0 | 86,0 |

Profilo maggiore estensibilità

Wall profile adjustment - Verlängerungsprofil - Profilé pour extension supplémentaire

| Codice - Code <i>Artikel - Article</i> | Formato (cm) - Size <i>Format - Dimension</i> | + cm. | Prezzo (€) - Price <i>Preis - Prix</i> |
|--|---|--------------|--|
| MTP 03F | 5,4 x 200 | 2,0 | 67,00 |

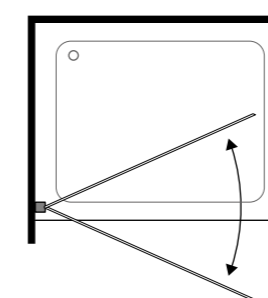
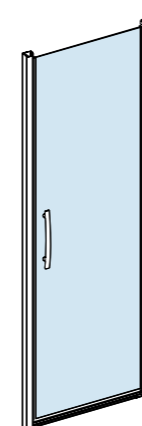
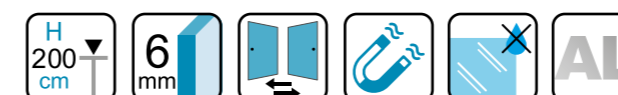

PROFILO A MURO
WALL PROFILE - WANDPROFIL - PROFIL DE MUR

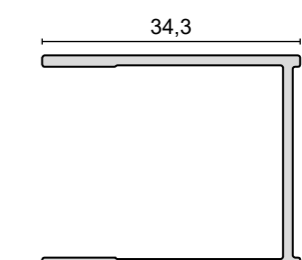

TRATTAMENTO ANTICALCARE

Descaling
Entkalkungsbehandlung
Traitement anticalcaire

GIGLIO EVO

CRISTALLO TRASPARENTE
TRANSPARENT CRYSTAL
TRANSPARENTES KRISTALLGLAS
VERRE TRANSPARENT

6 mm

BATTENTE PIVOT

| CODICE <i>Code - Artikel - Article</i> | Formato (cm) <i>Size - Format - Dimension</i> | Estensibilità <i>Extensibility - Streckbarkeit - Extensibilité</i> | Prezzo (€) <i>Price - Preis - Prix</i> | E <i>cm</i> | Ingombro porta <i>Door space Tür-Raumbedarf Passage</i> | Lato porta <i>Door - Tür - Porte</i> |
|--|---|--|--|-----------------------|---|--|
| LPB3 7016 | 70 | 66 ÷ 70 | 560,00 | 56,0 | 56,0 | • |
| LPB3 7516 | 75 | 71 ÷ 75 | 568,00 | 61,0 | 61,0 | • |
| LPB3 8016 | 80 | 76 ÷ 80 | 581,00 | 66,0 | 66,0 | • |
| LPB3 8516 | 85 | 81 ÷ 85 | 598,00 | 71,0 | 71,0 | • |
| LPB3 9016 | 90 | 86 ÷ 90 | 603,00 | 76,0 | 76,0 | • |
| LPB3 9516 | 95 | 91 ÷ 95 | 622,00 | 81,0 | 81,0 | • |
| LPB3 10016 | 100 | 96 ÷ 100 | 624,00 | 86,0 | 86,0 | • |

Parete fissa - Pezzi da ordinare
*Side - Necessary pieces
Seite - Notwendige Stücke
Paroi fixe - Paroi à commander*

| | | | | |
|--------------------|-----|---------|--------|----------|
| LPB3 17016 | 70 | 67 ÷ 69 | 445,00 | 1 |
| LPB3 17516 | 75 | 72 ÷ 74 | 454,00 | 1 |
| LPB3 18016 | 80 | 77 ÷ 79 | 463,00 | 1 |
| LPB3 18516 | 85 | 82 ÷ 84 | 480,00 | 1 |
| LPB3 19016 | 90 | 87 ÷ 89 | 481,00 | 1 |
| LPB3 110016 | 100 | 97 ÷ 99 | 530,00 | 1 |

Profilo maggiore estensibilità

Wall profile adjustment - Verlängerungsprofil - Profilé pour extension supplémentaire

| Codice - Code <i>Artikel - Article</i> | Formato (cm) - Size <i>Format - Dimension</i> | + cm. | Prezzo (€) - Price <i>Preis - Prix</i> |
|--|---|--------------|--|
| MTP 03F | 5,4 x 200 | 2,0 | 67,00 |

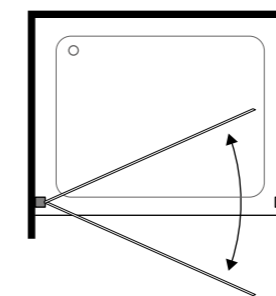
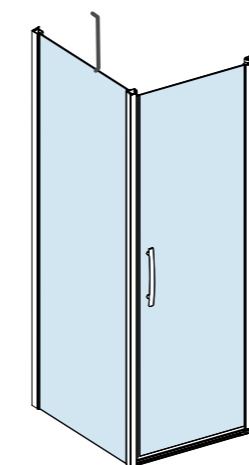
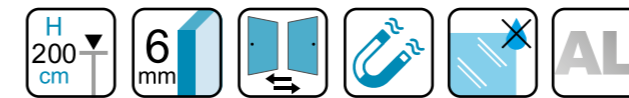

PROFILO A MURO WALL PROFILE - WANDPROFIL - PROFIL DE MUR

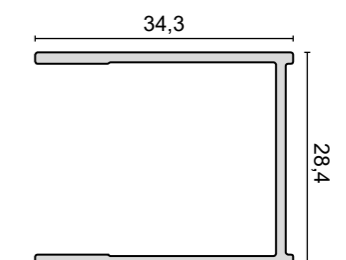

TRATTAMENTO ANTICALCARE

Descaling
Entkalkungsbehandlung
Traitement anticalcaire

GIGLIO EVO

CRISTALLO TRASPARENTE
TRANSPARENT CRYSTAL
TRANSPARENTES KRISTALLGLAS
VERRE TRANSPARENT

6 mm

BATTENTE PIVOT

| CODICE <i>Code - Artikel - Article</i> | Formato (cm) <i>Size - Format - Dimension</i> | Estensibilità <i>Extensibility - Streckbarkeit - Extensibilité</i> | Prezzo (€) <i>Price - Preis - Prix</i> | E <i>cm</i> | Ingombro porta <i>Door space Tür-Raumbedarf Passage</i> | Lato porta <i>Door - Tür - Porte</i> |
|--|---|--|--|-----------------------|---|--|
| LPB3 7016 | 70 | 66 ÷ 70 | 560,00 | 56,0 | 56,0 | • |
| LPB3 7516 | 75 | 71 ÷ 75 | 568,00 | 61,0 | 61,0 | • |
| LPB3 8016 | 80 | 76 ÷ 80 | 581,00 | 66,0 | 66,0 | • |
| LPB3 8516 | 85 | 81 ÷ 85 | 598,00 | 71,0 | 71,0 | • |
| LPB3 9016 | 90 | 86 ÷ 90 | 603,00 | 76,0 | 76,0 | • |
| LPB3 9516 | 95 | 91 ÷ 95 | 622,00 | 81,0 | 81,0 | • |
| LPB3 10016 | 100 | 96 ÷ 100 | 624,00 | 86,0 | 86,0 | • |

Parete fissa - Pezzi da ordinare
*Side - Necessary pieces
Seite - Notwendige Stücke
Paroi fixe - Paroi à commander*

| | | | | |
|--------------------|-----|---------|--------|----------|
| LPB3 17016 | 70 | 67 ÷ 69 | 445,00 | 2 |
| LPB3 17516 | 75 | 72 ÷ 74 | 454,00 | 2 |
| LPB3 18016 | 80 | 77 ÷ 79 | 463,00 | 2 |
| LPB3 18516 | 85 | 82 ÷ 84 | 480,00 | 2 |
| LPB3 19016 | 90 | 87 ÷ 89 | 481,00 | 2 |
| LPB3 110016 | 100 | 97 ÷ 99 | 530,00 | 2 |

Profilo maggiore estensibilità

Wall profile adjustment - Verlängerungsprofil - Profilé pour extension supplémentaire

| Codice - Code <i>Artikel - Article</i> | Formato (cm) - Size <i>Format - Dimension</i> | + cm. | Prezzo (€) - Price <i>Preis - Prix</i> |
|--|---|--------------|--|
| MTP 03F | 5,4 x 200 | 2,0 | 67,00 |

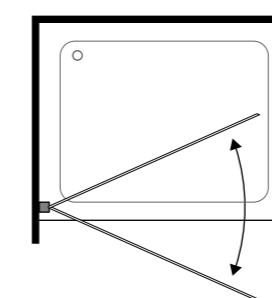
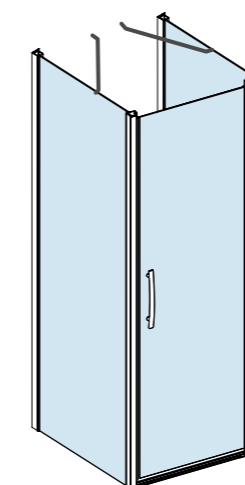
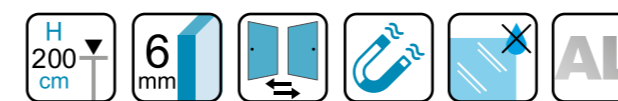

PROFILO A MURO
WALL PROFILE - WANDPROFIL - PROFIL DE MUR

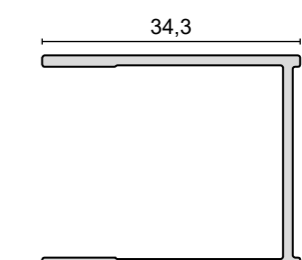

TRATTAMENTO ANTICALCARE

Etching
Entkalkungsbehandlung
Traitement anticraie

GIGLIO EVO BT

CRISTALLO TRASPARENTE / PROFILO NERO SATINATO

TRANSPARENT CRYSTAL / BLACK SATIN PROFILE
TRANSPARENTES KRISTALLGLAS / SCHWARZ-SATINIERTES PROFIL
VERRE TRANSPARENT / PROFILÉ NOIR SATINÉ

6 mm

BATTENTE PIVOT

| CODICE <i>Code - Artikel - Article</i> | Formato (cm) <i>Size - Format - Dimension</i> | Estensibilità <i>Extensibility - Streckbarkeit - Extensibilité</i> | Prezzo (€) <i>Price - Preis - Prix</i> | E <small>cm</small> | Ingombro porta - Door space <i>Tür-Raumbedarf - Passage</i> |
|---|--|---|---|-------------------------------|--|
| LPB3 7016BT | 70 | 66 ÷ 70 | 598,00 | 56,0 | 56,0 |
| LPB3 7516BT | 75 | 71 ÷ 75 | 610,00 | 61,0 | 61,0 |
| LPB3 8016BT | 80 | 76 ÷ 80 | 613,00 | 66,0 | 66,0 |
| LPB3 8516BT | 85 | 81 ÷ 85 | 630,00 | 71,0 | 71,0 |
| LPB3 9016BT | 90 | 86 ÷ 90 | 642,00 | 76,0 | 76,0 |
| LPB3 9516BT | 95 | 91 ÷ 95 | 654,00 | 81,0 | 81,0 |
| LPB3 10016BT | 100 | 96 ÷ 100 | 663,00 | 86,0 | 86,0 |

Profilo maggiore estensibilità

Wall profile adjustment - Verlängerungsprofil - Profilé pour extension supplémentaire

| Codice - Code Artikel - Article | Formato (cm) - Size Format - Dimension | + cm. | Prezzo (€) - Price Preis - Prix |
|------------------------------------|---|-------|------------------------------------|
| MTP 03FB | 5,4 x 200 | 2,0 | 70,00 |

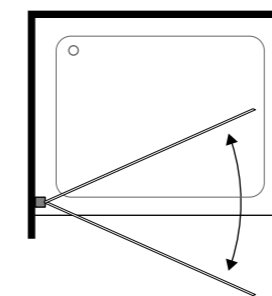
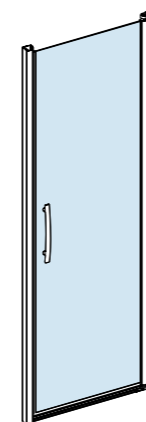
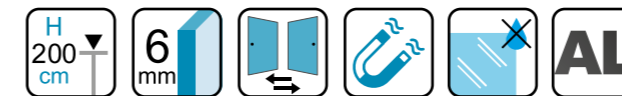

PROFILO A MURO WALL PROFILE - WANDPROFIL - PROFIL DE MUR

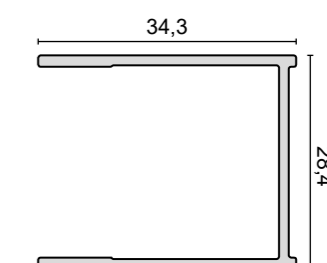



TRATTAMENTO ANTICALCARE
 Descaling
 Entkalkungsbehandlung
 Traitement anticalcaire

GIGLIO EVO BT

CRISTALLO TRASPARENTE / PROFILO NERO SATINATO
 TRANSPARENT CRYSTAL / BLACK SATIN PROFILE
 TRANSPARENTES KRISTALLGLAS / SCHWARZ-SATINIERTES PROFIL
 VERRE TRANSPARENT / PROFILÉ NOIR SATINÉ

6 mm
 BATTENTE
 PIVOT

| CODICE Code - Artikel - Article | Formato (cm) Size - Format - Dimension | Estensibilità Extensibility - Streckbarkeit - Extensibilité | Prezzo (€) Price - Preis - Prix | E cm | Ingombro porta Door space Tür-Raumbedarf Passage | Lato porta Door - Tür - Porte |
|---|--|---|---|----------------|--|---|
| LPB3 7016BT | 70 | 66 ÷ 70 | 598,00 | 56,0 | 56,0 | • |
| LPB3 7516BT | 75 | 71 ÷ 75 | 610,00 | 61,0 | 61,0 | • |
| LPB3 8016BT | 80 | 76 ÷ 80 | 613,00 | 66,0 | 66,0 | • |
| LPB3 8516BT | 85 | 81 ÷ 85 | 630,00 | 71,0 | 71,0 | • |
| LPB3 9016BT | 90 | 86 ÷ 90 | 642,00 | 76,0 | 76,0 | • |
| LPB3 9516BT | 95 | 91 ÷ 95 | 654,00 | 81,0 | 81,0 | • |
| LPB3 10016BT | 100 | 96 ÷ 100 | 663,00 | 86,0 | 86,0 | • |

Parete fissa - Pezzi da ordinare
 Side - Necessary pieces
 Seite - Notwendige Stücke
 Paroi fixe - Paroi à commander

| | | | | |
|--------------|----|---------|--------|----------|
| LPB3 17016BT | 70 | 67 ÷ 69 | 449,00 | 1 |
| LPB3 18016BT | 80 | 77 ÷ 79 | 478,00 | 1 |
| LPB3 19016BT | 90 | 87 ÷ 89 | 507,00 | 1 |

Profilo maggiore estensibilità

Wall profile adjustment - Verlängerungsprofil - Profilé pour extension supplémentaire

| Codice - Code Artikel - Article | Formato (cm) - Size Format - Dimension | + cm. | Prezzo (€) - Price Preis - Prix |
|---|--|--------------|---|
| MTP 03FB | 5,4 x 200 | 2,0 | 70,00 |

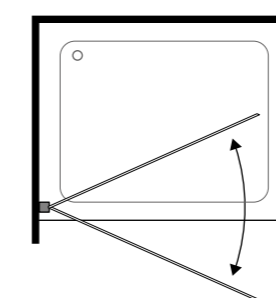
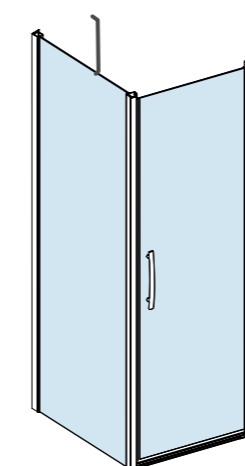
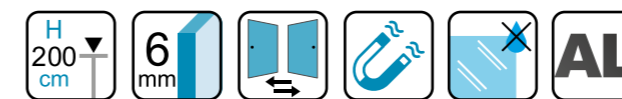

PROFILO A MURO WALL PROFILE - WANDPROFIL - PROFIL DE MUR

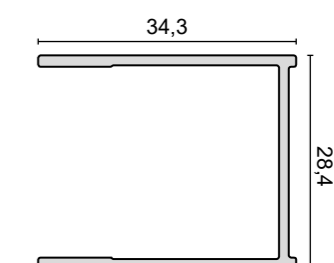



GIGLIO EVO BT

CRISTALLO TRASPARENTE / PROFILO NERO SATINATO
 TRANSPARENT CRYSTAL / BLACK SATIN PROFILE
 TRANSPARENTES KRISTALLGLAS / SCHWARZ-SATINIERTES PROFIL
 VERRE TRANSPARENT / PROFILÉ NOIR SATINÉ

6 mm
 BATTENTE
 PIVOT

| CODICE <i>Code - Artikel - Article</i> | Formato (cm) <i>Size - Format - Dimension</i> | Estensibilità <i>Extensibility - Streckbarkeit - Extensibilité</i> | Prezzo (€) <i>Price - Preis - Prix</i> |  | Ingombro porta <i>Door space Tür-Raumbedarf Passage</i> | Lato porta <i>Door - Tür - Porte</i> |
|---|--|---|---|---|--|---|
| LPB3 7016BT | 70 | 66 ÷ 70 | 598,00 | 56,0 | 56,0 | • |
| LPB3 7516BT | 75 | 71 ÷ 75 | 610,00 | 61,0 | 61,0 | • |
| LPB3 8016BT | 80 | 76 ÷ 80 | 613,00 | 66,0 | 66,0 | • |
| LPB3 8516BT | 85 | 81 ÷ 85 | 630,00 | 71,0 | 71,0 | • |
| LPB3 9016BT | 90 | 86 ÷ 90 | 642,00 | 76,0 | 76,0 | • |
| LPB3 9516BT | 95 | 91 ÷ 95 | 654,00 | 81,0 | 81,0 | • |
| LPB3 10016BT | 100 | 96 ÷ 100 | 663,00 | 86,0 | 86,0 | • |

Parete fissa - Pezzi da ordinare
*Side - Necessary pieces
 Seite - Notwendige Stücke
 Paroi fixe - Paroi à commander*

| | | | | |
|--------------|----|---------|--------|---|
| LPB3 17016BT | 70 | 67 ÷ 69 | 449,00 | 2 |
| LPB3 18016BT | 80 | 77 ÷ 79 | 478,00 | 2 |
| LPB3 19016BT | 90 | 87 ÷ 89 | 507,00 | 2 |

Profilo maggiore estensibilità

Wall profile adjustment - Verlängerungsprofil - Profilé pour extension supplémentaire

| Codice - Code Artikel - Article | Formato (cm) - Size Format - Dimension | + cm. | Prezzo (€) - Price Preis - Prix |
|------------------------------------|---|-------|------------------------------------|
| MTP 03FB | 5,4 x 200 | 2,0 | 70,00 |

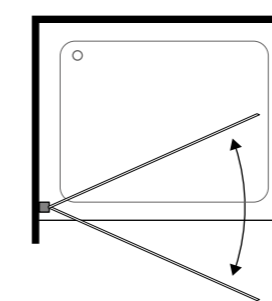
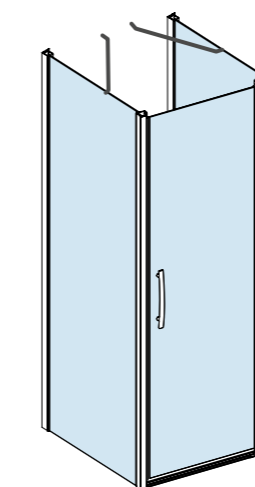
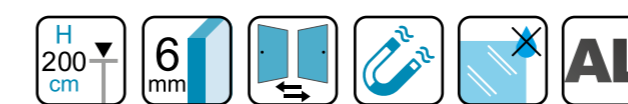

PROFILO A MURO WALL PROFILE - WANDPROFIL - PROFIL DE MUR

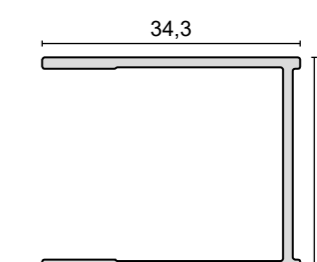



GIGLIO EVO BLACK

CRISTALLO GRIGIO / PROFILO NERO SATINATO
 GREY CRYSTAL / BLACK SATIN PROFILE
 GRAUES KRISTALLGLAS / SCHWARZ-SATINIERTES PROFIL
 VERRE FUMÉ / PROFILÉ NOIR SATINÉ

6 mm

BATTENTE PIVOT

| CODICE <i>Code - Artikel - Article</i> | Formato (cm) <i>Size - Format - Dimension</i> | Estensibilità <i>Extensibility - Streckbarkeit - Extensibilité</i> | Prezzo (€) <i>Price - Preis - Prix</i> | E <i>cm</i> | Ingombro porta - Door space <i>Tür-Raumbedarf - Passage</i> |
|--|---|--|--|-----------------------|---|
| LPB3 7016B | 70 | 66 ÷ 70 | 598,00 | 56,0 | 56,0 |
| LPB3 7516B | 75 | 71 ÷ 75 | 610,00 | 61,0 | 61,0 |
| LPB3 8016B | 80 | 76 ÷ 80 | 613,00 | 66,0 | 66,0 |
| LPB3 8516B | 85 | 81 ÷ 85 | 630,00 | 71,0 | 71,0 |
| LPB3 9016B | 90 | 86 ÷ 90 | 642,00 | 76,0 | 76,0 |
| LPB3 9516B | 95 | 91 ÷ 95 | 654,00 | 81,0 | 81,0 |
| LPB3 10016B | 100 | 96 ÷ 100 | 663,00 | 86,0 | 86,0 |

Profilo maggiore estensibilità

Wall profile adjustment - Verlängerungsprofil - Profilé pour extension supplémentaire

| Codice - Code <i>Artikel - Article</i> | Formato (cm) - Size <i>Format - Dimension</i> | + cm. | Prezzo (€) - Price <i>Preis - Prix</i> |
|--|---|--------------|--|
| MTP 03FB | 5,4 x 200 | 2,0 | 70,00 |

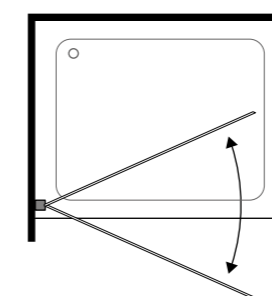
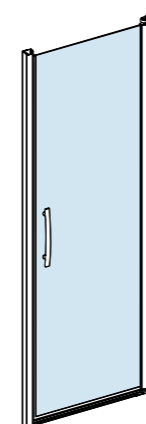
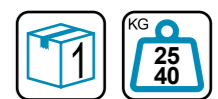
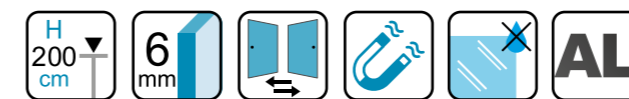

PROFILO A MURO WALL PROFILE - WANDPROFIL - PROFIL DE MUR

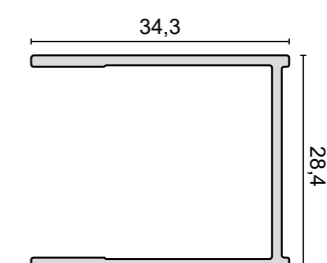

TRATTAMENTO ANTICALCARE
 Descaling
 Entkalkungsbehandlung
 Traitement anticalcaire



GIGLIO EVO BLACK

CRISTALLO GRIGIO / PROFILO NERO SATINATO
 GREY CRYSTAL / BLACK SATIN PROFILE
 GRAUES KRISTALLGLAS / SCHWARZ-SATINIERTES PROFIL
 VERRE FUMÉ / PROFILÉ NOIR SATINÉ

6 mm

BATTENTE PIVOT

| CODICE <i>Code - Artikel - Article</i> | Formato (cm) <i>Size - Format - Dimension</i> | Estensibilità <i>Extensibility - Streckbarkeit - Extensibilité</i> | Prezzo (€) <i>Price - Preis - Prix</i> | E <i>cm</i> | Ingombro porta <i>Door space Tür-Raumbedarf Passage</i> | Lato porta <i>Door - Tür - Porte</i> |
|--|---|--|--|-----------------------|---|--|
| LPB3 7016B | 70 | 66 ÷ 70 | 598,00 | 56,0 | 56,0 | • |
| LPB3 7516B | 75 | 71 ÷ 75 | 610,00 | 61,0 | 61,0 | • |
| LPB3 8016B | 80 | 76 ÷ 80 | 613,00 | 66,0 | 66,0 | • |
| LPB3 8516B | 85 | 81 ÷ 85 | 630,00 | 71,0 | 71,0 | • |
| LPB3 9016B | 90 | 86 ÷ 90 | 642,00 | 76,0 | 76,0 | • |
| LPB3 9516B | 95 | 91 ÷ 95 | 654,00 | 81,0 | 81,0 | • |
| LPB3 10016B | 100 | 96 ÷ 100 | 663,00 | 86,0 | 86,0 | • |

Parete fissa - Pezzi da ordinare
*Side - Necessary pieces
 Seite - Notwendige Stücke
 Paroi fixe - Paroi à commander*

| | | | | |
|--------------------|----|---------|--------|----------|
| LPB3 17016B | 70 | 67 ÷ 69 | 449,00 | 1 |
| LPB3 18016B | 80 | 77 ÷ 79 | 478,00 | 1 |
| LPB3 19016B | 90 | 87 ÷ 89 | 507,00 | 1 |

Profilo maggiore estensibilità

Wall profile adjustment - Verlängerungsprofil - Profilé pour extension supplémentaire

| Codice - Code <i>Artikel - Article</i> | Formato (cm) - Size <i>Format - Dimension</i> | + cm. | Prezzo (€) - Price <i>Preis - Prix</i> |
|--|---|--------------|--|
| MTP 03FB | 5,4 x 200 | 2,0 | 70,00 |

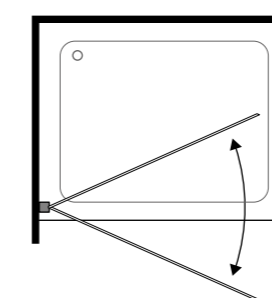
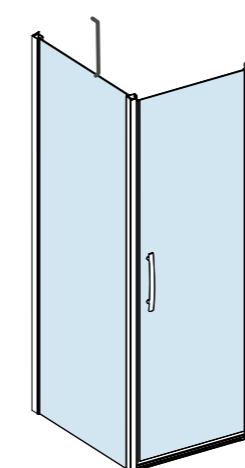
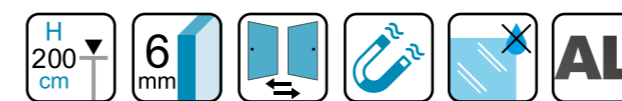

PROFILO A MURO WALL PROFILE - WANDPROFIL - PROFIL DE MUR

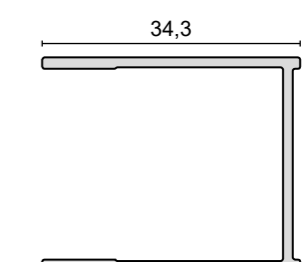

TRATTAMENTO ANTICALCARE

Descaling
Entkalkungsbehandlung
Traitement anticalcaire

GIGLIO EVO BLACK

CRISTALLO GRIGIO / PROFILO NERO SATINATO

GREY CRYSTAL / BLACK SATIN PROFILE
GRAUES KRISTALLGLAS / SCHWARZ-SATINIERTES PROFIL
VERRE FUMÉ / PROFILÉ NOIR SATINÉ

6 mm

BATTENTE PIVOT

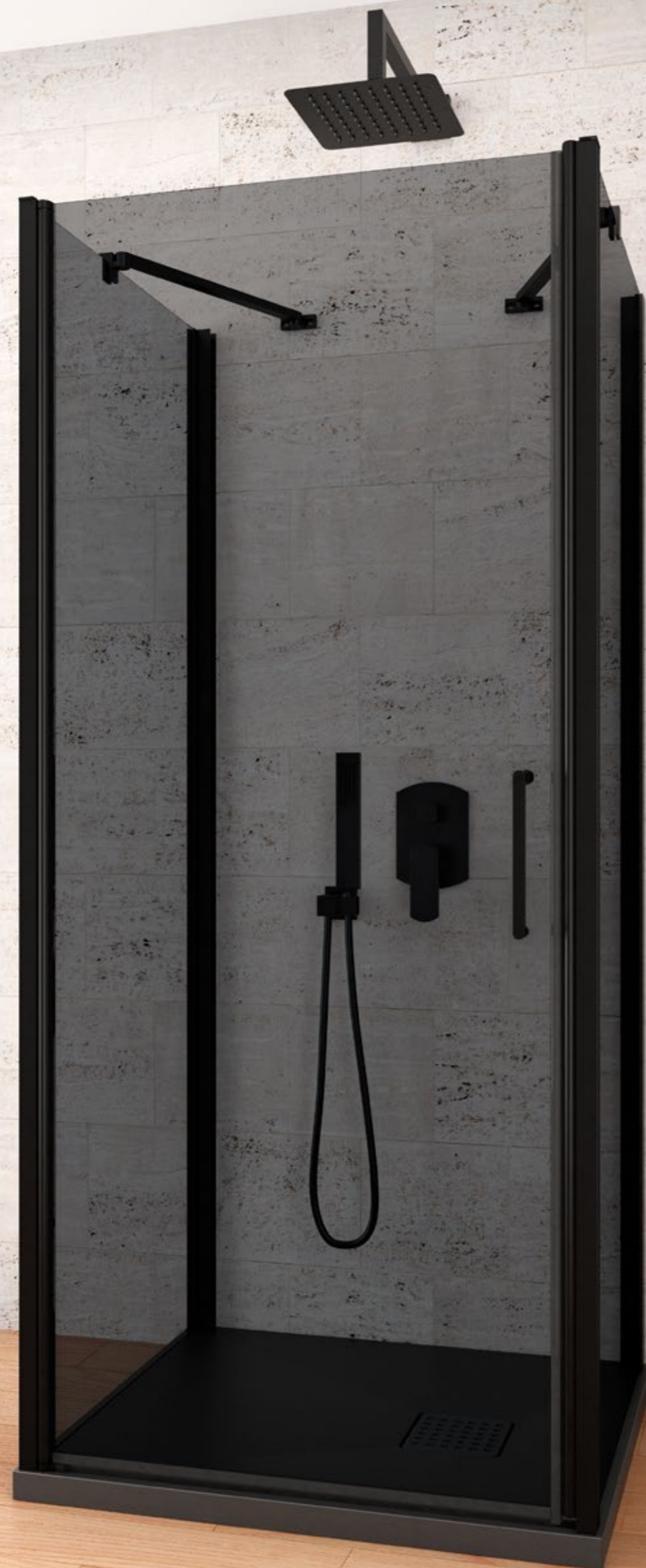

| CODICE <i>Code - Artikel - Article</i> | Formato (cm) <i>Size - Format - Dimension</i> | Estensibilità <i>Extensibility - Streckbarkeit - Extensibilité</i> | Prezzo (€) <i>Price - Preis - Prix</i> |  | Ingombro porta <i>Door space Tür-Raumbedarf Passage</i> | Lato porta <i>Door - Tür - Porte</i> |
|---|--|---|---|---|--|---|
| LPB3 7016B | 70 | 66 ÷ 70 | 598,00 | 56,0 | 56,0 | • |
| LPB3 7516B | 75 | 71 ÷ 75 | 610,00 | 61,0 | 61,0 | • |
| LPB3 8016B | 80 | 76 ÷ 80 | 613,00 | 66,0 | 66,0 | • |
| LPB3 8516B | 85 | 81 ÷ 85 | 630,00 | 71,0 | 71,0 | • |
| LPB3 9016B | 90 | 86 ÷ 90 | 642,00 | 76,0 | 76,0 | • |
| LPB3 9516B | 95 | 91 ÷ 95 | 654,00 | 81,0 | 81,0 | • |
| LPB3 10016B | 100 | 96 ÷ 100 | 663,00 | 86,0 | 86,0 | • |

Parete fissa - Pezzi da ordinare
*Side - Necessary pieces
Seite - Notwendige Stücke
Paroi fixe - Paroi à commander*

| | | | | |
|-------------|----|---------|--------|---|
| LPB3 17016B | 70 | 67 ÷ 69 | 449,00 | 2 |
| LPB3 18016B | 80 | 77 ÷ 79 | 478,00 | 2 |
| LPB3 19016B | 90 | 87 ÷ 89 | 507,00 | 2 |

Profilo maggiore estensibilità

Wall profile adjustment - Verlängerungsprofil - Profilé pour extension supplémentaire

| Codice - Code Artikel - Article | Formato (cm) - Size Format - Dimension | + cm. | Prezzo (€) - Price Preis - Prix |
|------------------------------------|---|-------|------------------------------------|
| MTP 03FB | 5,4 x 200 | 2,0 | 70,00 |

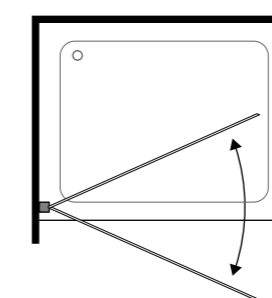
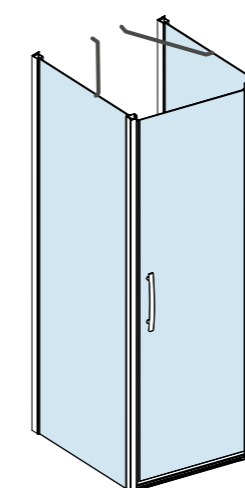
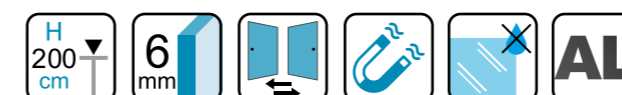

PROFILO A MURO WALL PROFILE - WANDPROFIL - PROFIL DE MUR

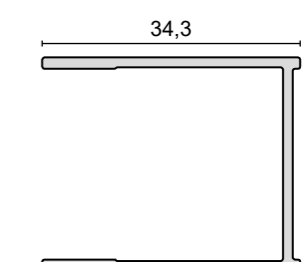

TRATTAMENTO ANTICALCARE

Descaling
Entkalkungsbehandlung
Traitement anticalcaire

GIGLIO EVO FOX

CRISTALLO PIUMATO
FOX CRYSTAL
FOX KRISTALLGLAS
VERRE GRANITÉ

6 mm

BATTENTE PIVOT

| CODICE <i>Code - Artikel - Article</i> | Formato (cm) <i>Size - Format - Dimension</i> | Estensibilità <i>Extensibility - Streckbarkeit - Extensibilité</i> | Prezzo (€) <i>Price - Preis - Prix</i> | E <small>cm</small> | Ingombro porta - Door space <i>Tür-Raumbedarf - Passage</i> |
|---|--|---|---|-------------------------------|--|
| LPB3 7016F | 70 | 66 ÷ 70 | 603,00 | 56,0 | 56,0 |
| LPB3 7516F | 75 | 71 ÷ 75 | 614,00 | 61,0 | 61,0 |
| LPB3 8016F | 80 | 76 ÷ 80 | 629,00 | 66,0 | 66,0 |
| LPB3 9016F | 90 | 86 ÷ 90 | 668,00 | 76,0 | 76,0 |
| LPB3 10016F | 100 | 96 ÷ 100 | 686,00 | 86,0 | 86,0 |

Profilo maggiore estensibilità

Wall profile adjustment - Verlängerungsprofil - Profilé pour extension supplémentaire

| Codice - Code Artikel - Article | Formato (cm) - Size Format - Dimension | + cm. | Prezzo (€) - Price Preis - Prix |
|------------------------------------|---|-------|------------------------------------|
| MTP 03F | 5,4 x 200 | 2,0 | 67,00 |

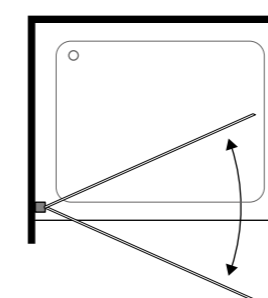
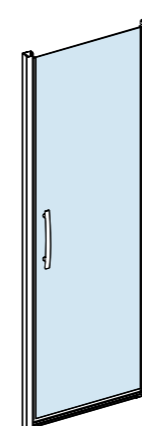
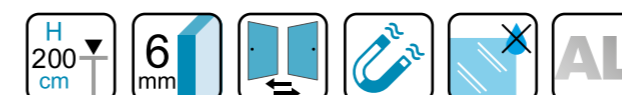

PROFILO A MURO
WALL PROFILE - WANDPROFIL - PROFIL DE MUR

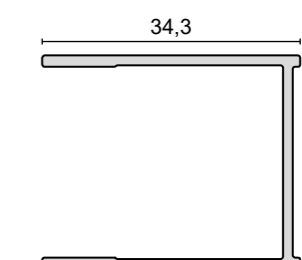

TRATTAMENTO
ANTICALCARE

Descaling
Entkalkungsbehandlung
Traitement anticalc

GIGLIO EVO FOX

CRISTALLO PIUMATO

FOX CRYSTAL
FOX KRISTALLGLAS
VERRE GRANITÉ

6
mm

BATTENTE
PIVOT

| CODICE <i>Code - Artikel - Article</i> | Formato (cm) <i>Size - Format - Dimension</i> | Estensibilità <i>Extensibility - Streckbarkeit - Extensibilité</i> | Prezzo (€) <i>Price - Preis - Prix</i> | E <small>cm</small> | Ingombro porta <i>Door space Tür-Raumbedarf Passage</i> | Lato porta <i>Door - Tür - Porte</i> |
|---|--|---|---|-------------------------------|--|---|
| LPB3 7016F | 70 | 66 ÷ 70 | 603,00 | 56,0 | 56,0 | • |
| LPB3 7516F | 75 | 71 ÷ 75 | 614,00 | 61,0 | 61,0 | • |
| LPB3 8016F | 80 | 76 ÷ 80 | 629,00 | 66,0 | 66,0 | • |
| LPB3 9016F | 90 | 86 ÷ 90 | 668,00 | 76,0 | 76,0 | • |
| LPB3 10016F | 100 | 96 ÷ 100 | 686,00 | 86,0 | 86,0 | • |

Parete fissa - Pezzi da ordinare
*Side - Necessary pieces
Seite - Notwendige Stücke
Paroi fixe - Paroi à commander*

| | | | | |
|-------------|----|---------|--------|---|
| LPB3 17016F | 70 | 67 ÷ 69 | 449,00 | 1 |
| LPB3 17516F | 75 | 72 ÷ 74 | 467,00 | 1 |
| LPB3 18016F | 80 | 77 ÷ 79 | 470,00 | 1 |
| LPB3 19016F | 90 | 87 ÷ 89 | 497,00 | 1 |

Profilo maggiore estensibilità

Wall profile adjustment - Verlängerungsprofil - Profilé pour extension supplémentaire

| Codice - Code Artikel - Article | Formato (cm) - Size Format - Dimension | + cm. | Prezzo (€) - Price Preis - Prix |
|------------------------------------|---|-------|------------------------------------|
| MTP 03F | 5,4 x 200 | 2,0 | 67,00 |

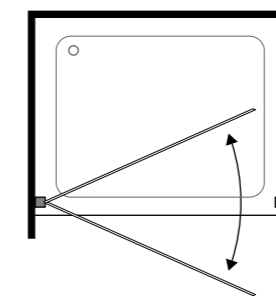
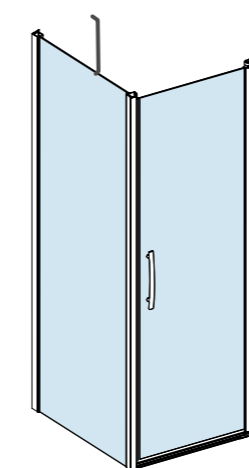
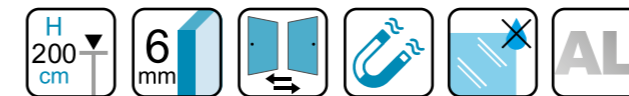

PROFILO A MURO WALL PROFILE - WANDPROFIL - PROFIL DE MUR

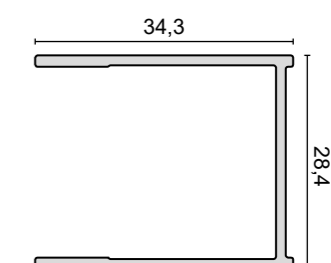

TRATTAMENTO ANTICALCARE

Descaling
Entkalkungsbehandlung
Traitement anticalcaire

GIGLIO EVO FOX

CRISTALLO PIUMATO
FOX CRYSTAL
FOX KRISTALLGLAS
VERRE GRANITÉ

6 mm

BATTENTE PIVOT

| CODICE <i>Code - Artikel - Article</i> | Formato (cm) <i>Size - Format - Dimension</i> | Estensibilità <i>Extensibility - Streckbarkeit - Extensibilité</i> | Prezzo (€) <i>Price - Preis - Prix</i> | E <i>cm</i> | Ingombro porta <i>Door space Tür-Raumbedarf Passage</i> | Lato porta <i>Door - Tür - Porte</i> |
|---|--|---|---|-----------------------|--|---|
| LPB3 7016F | 70 | 66 ÷ 70 | 603,00 | 56,0 | 56,0 | • |
| LPB3 7516F | 75 | 71 ÷ 75 | 614,00 | 61,0 | 61,0 | • |
| LPB3 8016F | 80 | 76 ÷ 80 | 629,00 | 66,0 | 66,0 | • |
| LPB3 9016F | 90 | 86 ÷ 90 | 668,00 | 76,0 | 76,0 | • |
| LPB3 10016F | 100 | 96 ÷ 100 | 686,00 | 86,0 | 86,0 | • |

Parete fissa - Pezzi da ordinare
*Side - Necessary pieces
Seite - Notwendige Stücke
Paroi fixe - Paroi à commander*

| | | | | |
|-------------|----|---------|--------|---|
| LPB3 17016F | 70 | 67 ÷ 69 | 449,00 | 2 |
| LPB3 17516F | 75 | 72 ÷ 74 | 467,00 | 2 |
| LPB3 18016F | 80 | 77 ÷ 79 | 470,00 | 2 |
| LPB3 19016F | 90 | 87 ÷ 89 | 497,00 | 2 |

Profilo maggiore estensibilità

Wall profile adjustment - Verlängerungsprofil - Profilé pour extension supplémentaire

| Codice - Code Artikel - Article | Formato (cm) - Size Format - Dimension | + cm. | Prezzo (€) - Price Preis - Prix |
|------------------------------------|---|-------|------------------------------------|
| MTP 03F | 5,4 x 200 | 2,0 | 67,00 |

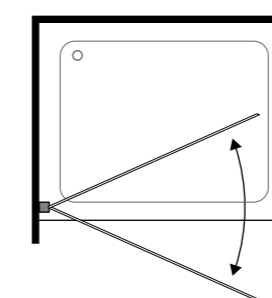
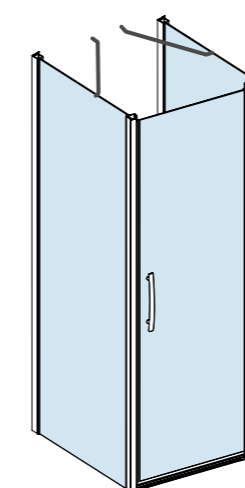
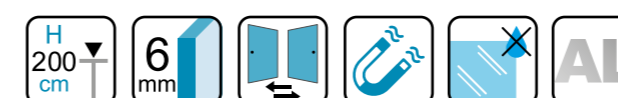

PROFILO A MURO
WALL PROFILE - WANDPROFIL - PROFIL DE MUR

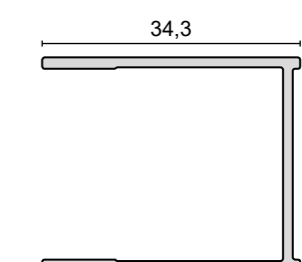



GIGLIO CORNER

CRISTALLO TRASPARENTE
TRANSPARENT CRYSTAL
TRANSPARENTES KRISTALLGLAS
VERRE TRANSPARENT

6 mm
BATTENTE
PIVOT

| CODICE <i>Code - Artikel - Article</i> | Formato (cm) <i>Size - Format - Dimension</i> | Estensibilità <i>Extensibility - Streckbarkeit - Extensibilité</i> | Prezzo (€) <i>Price - Preis - Prix</i> | Singolo lato <i>Single side Einzel Seite - Seul côté</i> | Ingombro porta <i>Door space Tür-Raumbedarf - Passage</i> |
|---|--|---|---|---|--|
| LPB EVO 270 | 70 | 67 ÷ 69 | 479,00 | • | 60,0 |
| LPB EVO 275 | 75 | 72 ÷ 74 | 492,00 | • | 65,0 |
| LPB EVO 280 | 80 | 77 ÷ 79 | 495,00 | • | 70,0 |
| LPB EVO 290 | 90 | 87 ÷ 89 | 513,00 | • | 80,0 |
| LPB EVO 2100 | 100 | 97 ÷ 99 | 534,00 | • | 90,0 |

Profilo maggiore estensibilità

Wall profile adjustment - Verlängerungsprofil - Profilé pour extension supplémentaire

| Codice - Code Artikel - Article | Formato (cm) - Size Format - Dimension | + cm. | Prezzo (€) - Price Preis - Prix |
|------------------------------------|---|-------|------------------------------------|
| MTP 03E | 5,4 x 190 | 2,0 | 65,00 |

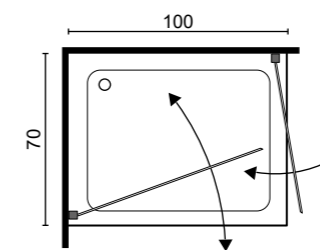
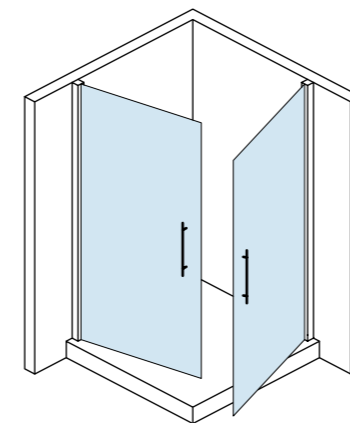

PROFILO A MURO WALL PROFILE - WANDPROFIL - PROFIL DE MUR

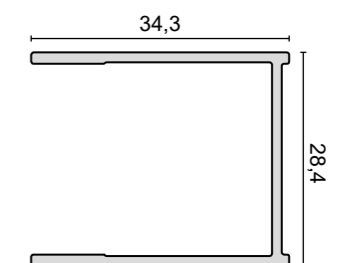

MONTECRISTO / GIGLIO EVO

LACUS RIVESTE... SU MISURA - LACUS MAKES IT... TO MEASURE - LACUS FERTIG ...MASSGERECHT - LACUS UNE FABRICATION SUR ...MESURE

Articoli speciali su ordinazione - Special Items on request - Sonderanfertigungen auf Bestellung - Articles 'à la carte' sur commande

| | LATO FISSO - FIXED PANEL FESTE SEITENWAND - PANNEAU FIXE | LATO PORTA DOOR - TÜR - PORTE | VETRO SOPRA MURETTO - GLASS ON THE WALL GLAS AN DER WAND - PAROI SUR MURET |
|---|---|---|--|
| MONTECRISTO | Altezza max 190 cm. - Larghezza max 150 cm. Height max 190 cm. - Width max 150 cm. Maximale Höhe 190 cm. - Maximale Breite 150 cm. Hauteur 190 cm. maximum - Largeur 150 cm. maximum | Altezza max 190 cm. - Larghezza max 200 cm. Height max 190 cm. - Width max 200 cm. Maximale Höhe 190 cm. - Maximale Breite 200 cm. Hauteur 190 cm. maximum - Largeur 200 cm. maximum | |
| | | | |
| GIGLIO | Altezza max 200 cm. - Larghezza max 150 cm. Height max 200 cm. - Width max 150 cm. Maximale Höhe 200 cm. - Maximale Breite 150 cm. Hauteur 200 cm. maximum - Largeur 150 cm. maximum | Altezza max 200 cm. - Larghezza max 200 cm. Height max 200 cm. - Width max 200 cm. Maximale Höhe 200 cm. - Maximale Breite 200 cm. Hauteur 200 cm. maximum - Largeur 200 cm. maximum | |
| | | | |
| | PREZZO DI LISTINO AL PEZZO (TRASPARENTE) GROSS PREIS PRO PIECE (TRANSPARENT) LISTENPREIS PRO STÜCK (TRANSPARENT) PRIX TARIF PAR PIÈCE (TRANSPARENT) | PREVENTIVO SU RICHIESTA PRICE ON REQUEST ANGEBOT AUF ANFRAGE DEVIS SUR DEMANDE | PREVENTIVO SU RICHIESTA PRICE ON REQUEST ANGEBOT AUF ANFRAGE DEVIS SUR DEMANDE |
| | FASCIA 1: da 0,01 a 0,50 mq Level 1: from 0.01 to 0.5 sqm € 592,00 | | |
| | FASCIA 2: da 0,51 a 1,00 mq Level 2: from 0.51 to 1.0 sqm € 672,00 | | |
| | FASCIA 3: da 1,01 a 1,50 mq Level 3: from 1.01 to 1.5 sqm € 768,00 | | |
| | FASCIA 4: da 1,51 a 2,00 mq Level 4: from 1.51 to 2.0 sqm € 850,00 | | |
| | FASCIA 5: da 2,01 a 2,50 mq Level 5: from 2.01 to 2.5 sqm € 934,00 | | |
| | FASCIA 6: da 2,51 a 3,00 mq Level 5: from 2.51 to 3.0 sqm € 1.040,00 | | |
| Maggiorazione per vetro Matt, Fox e Gray: +15% Surcharge for matt, fox and grey crystal + 15% Aufpreis für Matt, Fox und Grey Kristallglas +15% Majoration pour les verres Matt, Fox et Grey: +15% | | | |

ATTENZIONE:

CALCOLARE I MQ. DEL PEZZO PER STABILIRE LA FASCIA DI APPARTENENZA

Per soluzioni diverse da quelle contemplate contattare ns. ufficio tecnico per avere indicazioni di fattibilità e prezzi.

VORSICHT:

BERECHNEN DIE QM. DES STÜCKES, ZUR ERFÜLLUNG DER ZUGEHÖRIGEN BAND

Für andere als die in Betracht gezogenen Lösungen wenden Sie sich an unser technisches Büro, um Informationen zu Machbarkeit und Preisen zu erhalten.

ATTENTION:

CALCULATE THE SQM OF THE ARTIKEL TO ESTABLISH THE BELONGING LEVEL.

For information on feasibility and prices of other solutions, please get in touch with our technical dept.

ATTENTION:

CALCULER LES M². DE LA PAROI POUR ÉTABLIR LA TRANCHE D'APPARTENANCE

Pour d'autres solutions que celles envisagées, contactez notre bureau technique pour connaître la faisabilité et les tarifs.

DETTAGLI & CARATTERISTICHE

6 mm

BATTENTE PIVOT



PROFILO E CERNIERA - PROFILE AND HINGE
PROFIL UND SCHARNIER - PROFILÉ ET CHARNIÈRE

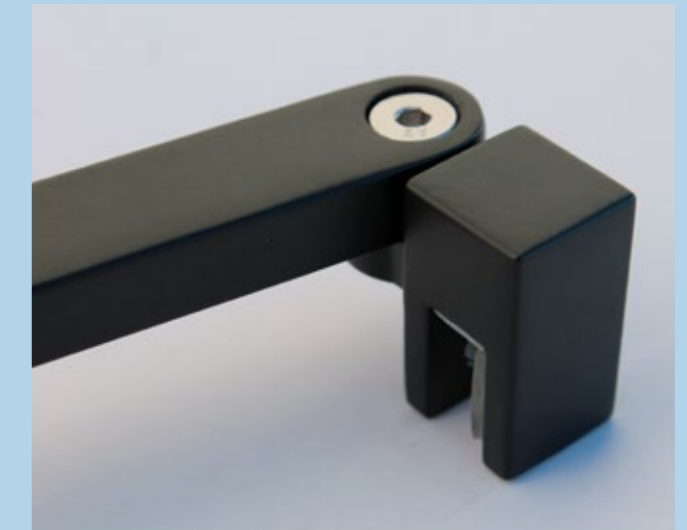

BRACCIO SNODABILE BLACK
BLACK ADJUSTABLE ARM
SCHWARZ VERSTELLBARER ARM
BARRE DE RENFORT ARTICULÉE NOIR SATINÉ

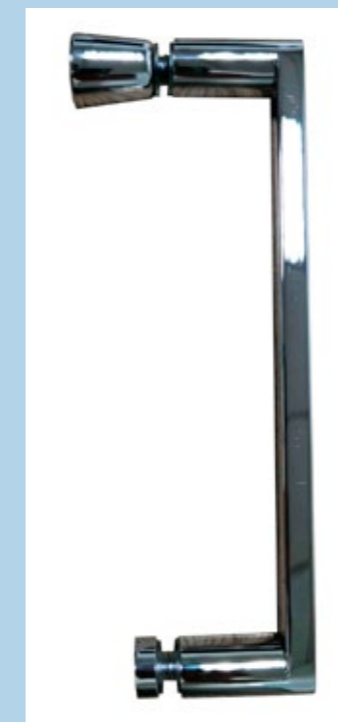

MANIGLIA
HANDLE - GRIFF - POIGNÉE

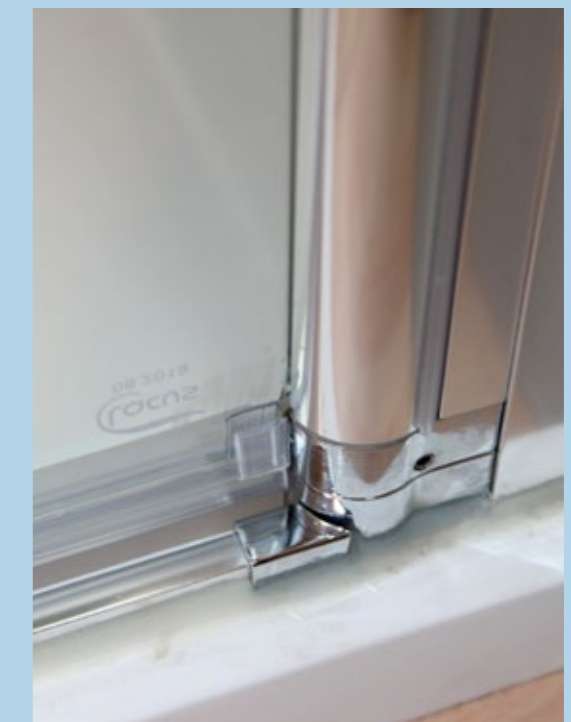

GUARNIZIONE INFERIORE - BOTTOM GASKET
UNTERE DICHTUNG - JOINT INFÉRIÈRE

CARATTERISTICHE GENERALI

- Cristallo temperato da 6 mm.
- Finitura trasparente, grey e piumato.
- Profilo in alluminio cromo lucido, laccato nero satinato.
- Chiusura magnetica delle ante.
- Chiusura ad anta battente.
- Estensione 2 cm.
- Maniglie in alluminio, cerniere in zama.

GENERAL FEATURES

- 6 mm tempered safety crystal.
- Transparent, gray, fox.
- Polished aluminum and black satin profile.
- Magnetic waterproof closure.
- Outwards/inwards opening.
- Extension 2 cm.
- Handles made of aluminum, hinge of zamak.

ALLGEMEINE SPEZIFIKATIONEN

- Sekurirkristallglas 6 mm stark.
- Kristallglasfinish: Transparent, Grau, Fox.
- Poliertes Chrom- und Schwarz-satiniertes Profil.
- Magnetverschluss der Türen.
- Drehtür.
- Streckbarkeit 2 cm.
- Griff aus Aluminium, Scharnier aus Zamak.

SPECIFICATIONS GENERALES

- Verre trempé 6 mm.
- Finition du verre: transparent, fumé ou imprimé.
- Profilé en aluminium chromé, blanc et noir satiné.
- Portes à fermeture magnétique.
- Ouverture pivotante.
- Extensibilité 2 cm.
- Poignées et charnières en aluminium, laiton et zinc.



TRATTAMENTO ANTICALCARE

Descaling
Entkalkungsbehandlung
Traitement anticalcaire

CAPRI MIRROR

CRISTALLO A SPECCHIO / TRASPARENTE

MIRROR / TRANSPARENT CRYSTAL
SPIEGEL- / TRANSPARENTES KRISTALLGLAS
VERRE MIROIR ET TRANSPARENT

| CODICE <i>Code - Artikel - Article</i> | Formato (cm) <i>Size - Format - Dimension</i> | Estensibilità <i>Extensibility - Streckbarkeit - Extensibilité</i> | Prezzo (€) <i>Price - Preis - Prix</i> | E <i>cm</i> | Lato porta <i>Door - Tür - Porte</i> |
|--|---|--|--|-----------------------|--|
| LCBAM2 12028 | 120 | 117,5 ÷ 119 | 1.282,00 | 48,0 | • |
| LCBAM2 13028 | 130 | 127,5 ÷ 129 | 1.375,00 | 53,0 | • |
| LCBAM2 14028 | 140 | 137,5 ÷ 139 | 1.465,00 | 58,0 | • |
| LCBAM2 15028 | 150 | 147,5 ÷ 149 | 1.560,00 | 63,0 | • |
| LCBAM2 16028 | 160 | 157,5 ÷ 159 | 1.650,00 | 68,0 | • |
| LCBAM2 17028 | 170 | 167,5 ÷ 169 | 1.749,00 | 73,0 | • |
| LCBAM2 18028 | 180 | 177,5 ÷ 179 | 1.870,00 | 78,0 | • |

8 mm
SCORREVOLI
SLIDING

Profilo maggiore estensibilità

Wall profile adjustment - Verlängerungsprofil - Profilé pour extension supplémentaire

| Codice - Code <i>Artikel - Article</i> | Formato (cm) - Size <i>Format - Dimension</i> | + cm. | Prezzo (€) - Price <i>Preis - Prix</i> |
|--|---|--------------|--|
| MTP 24 | 4,6 x 210 | 1,5 | 102,00 |

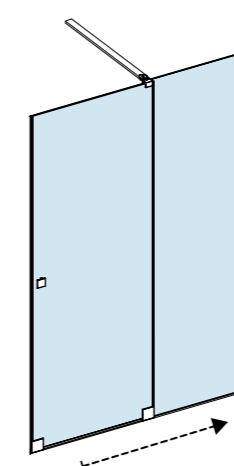

PROFILO A MURO
WALL PROFILE - WANDPROFIL - PROFIL DE MUR

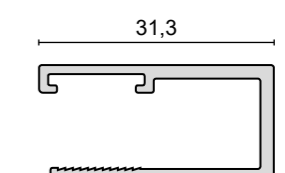

TRATTAMENTO ANTICALCARE

Descaling
Entkalkungsbehandlung
Traitement anticalcaire



CAPRI MIRROR

CRISTALLO TRASPARENTE
TRANSPARENT CRYSTAL
TRANSPARENTES KRISTALLGLAS
VERRE TRANSPARENT

| CODICE <i>Code - Artikel - Article</i> | Formato (cm) <i>Size - Format - Dimension</i> | Estensibilità <i>Extensibility - Streckbarkeit - Extensibilité</i> | Prezzo (€) <i>Price - Preis - Prix</i> | E <i>cm</i> | Lato porta <i>Door - Tür - Porte</i> |
|--|---|--|--|-----------------------|--|
| LCBAM2 12028 | 120 | 117,5 ÷ 119 | 1.282,00 | 48,0 | • |
| LCBAM2 13028 | 130 | 127,5 ÷ 129 | 1.375,00 | 53,0 | • |
| LCBAM2 14028 | 140 | 137,5 ÷ 139 | 1.465,00 | 58,0 | • |
| LCBAM2 15028 | 150 | 147,5 ÷ 149 | 1.560,00 | 63,0 | • |
| LCBAM2 16028 | 160 | 157,5 ÷ 159 | 1.650,00 | 68,0 | • |
| LCBAM2 17028 | 170 | 167,5 ÷ 169 | 1.749,00 | 73,0 | • |
| LCBAM2 18028 | 180 | 177,5 ÷ 179 | 1.870,00 | 78,0 | • |

Parete fissa - Pezzi da ordinare
Side - Necessary pieces
Seite - Notwendige Stücke
Paroi fixe - Paroi à commander

| | | | | |
|-------------|-----|-----------|--------|----------|
| LCBAF 7018 | 70 | 67,5 ÷ 69 | 541,00 | 1 |
| LCBAF 8018 | 80 | 77,5 ÷ 79 | 571,00 | 1 |
| LCBAF 9018 | 90 | 87,5 ÷ 89 | 606,00 | 1 |
| LCBAF 10018 | 100 | 97,5 ÷ 99 | 645,00 | 1 |

Profilo maggiore estensibilità

Wall profile adjustment - Verlängerungsprofil - Profilé pour extension supplémentaire

| Codice - Code <i>Artikel - Article</i> | Formato (cm) - Size <i>Format - Dimension</i> | + cm. | Prezzo (€) - Price <i>Preis - Prix</i> |
|--|---|--------------|--|
| MTP 24 | 4,6 x 210 | 1,5 | 102,00 |

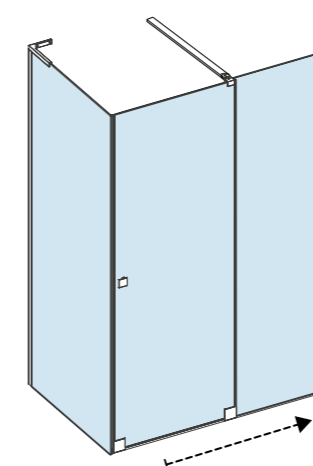
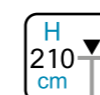

PROFILO A MURO
WALL PROFILE - WANDPROFIL - PROFIL DE MUR

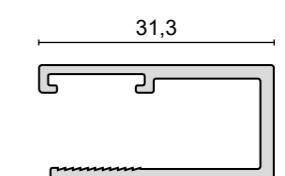

TRATTAMENTO ANTICALCARE

Descaling
Entkalkungsbehandlung
Traitement anticalcaire

CAPRI

CRISTALLO TRASPARENTE
TRANSPARENT CRYSTAL
TRANSPARENTES KRISTALLGLAS
VERRE TRANSPARENT

| CODICE <i>Code - Artikel - Article</i> | Formato (cm) <i>Size - Format - Dimension</i> | Estensibilità <i>Extensibility - Streckbarkeit - Extensibilité</i> | Prezzo (€) <i>Price - Preis - Prix</i> | E <i>cm</i> | Lato porta <i>Door - Tür - Porte</i> |
|--|---|--|--|-----------------------|--|
| LCBA 12028 | 120 | 117,5 ÷ 119 | 1.145,00 | 48,0 | • |
| LCBA 13028 | 130 | 127,5 ÷ 129 | 1.210,00 | 53,0 | • |
| LCBA 14028 | 140 | 137,5 ÷ 139 | 1.265,00 | 58,0 | • |
| LCBA 15028 | 150 | 147,5 ÷ 149 | 1.330,00 | 63,0 | • |
| LCBA 16028 | 160 | 157,5 ÷ 159 | 1.400,00 | 68,0 | • |
| LCBA 17028 | 170 | 167,5 ÷ 169 | 1.460,00 | 73,0 | • |
| LCBA 18028 | 180 | 177,5 ÷ 179 | 1.520,00 | 78,0 | • |

8 mm
SCORREVOLI
SLIDING

Profilo maggiore estensibilità

Wall profile adjustment - Verlängerungsprofil - Profilé pour extension supplémentaire

| Codice - Code <i>Artikel - Article</i> | Formato (cm) - Size <i>Format - Dimension</i> | + cm. | Prezzo (€) - Price <i>Preis - Prix</i> |
|--|---|--------------|--|
| MTP 24 | 4,6 x 210 | 1,5 | 102,00 |

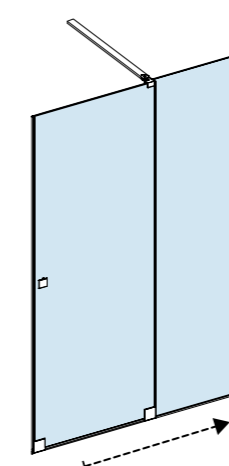

PROFILO A MURO
WALL PROFILE - WANDPROFIL - PROFIL DE MUR

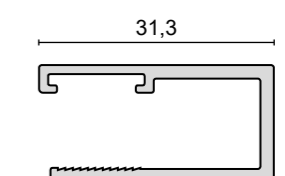

TRATTAMENTO ANTICALCARE

Descaling
Entkalkungsbehandlung
Traitement anticalcaire



CAPRI

CRISTALLO TRASPARENTE
TRANSPARENT CRYSTAL
TRANSPARENTES KRISTALLGLAS
VERRE TRANSPARENT

| CODICE <i>Code - Artikel - Article</i> | Formato (cm) <i>Size - Format - Dimension</i> | Estensibilità <i>Extensibility - Streckbarkeit - Extensibilité</i> | Prezzo (€) <i>Price - Preis - Prix</i> | E <i>cm</i> | Lato porta <i>Door - Tür - Porte</i> |
|--|---|--|--|-----------------------|--|
| LCBA 12028 | 120 | 117,5 ÷ 119 | 1.145,00 | 48,0 | • |
| LCBA 13028 | 130 | 127,5 ÷ 129 | 1.210,00 | 53,0 | • |
| LCBA 14028 | 140 | 137,5 ÷ 139 | 1.265,00 | 58,0 | • |
| LCBA 15028 | 150 | 147,5 ÷ 149 | 1.330,00 | 63,0 | • |
| LCBA 16028 | 160 | 157,5 ÷ 159 | 1.400,00 | 68,0 | • |
| LCBA 17028 | 170 | 167,5 ÷ 169 | 1.460,00 | 73,0 | • |
| LCBA 18028 | 180 | 177,5 ÷ 179 | 1.520,00 | 78,0 | • |

Parete fissa - Pezzi da ordinare
Side - Necessary pieces
Seite - Notwendige Stücke
Paroi fixe - Paroi à commander

| | | | | |
|-------------|-----|-----------|--------|----------|
| LCBAF 7018 | 70 | 67,5 ÷ 69 | 541,00 | 1 |
| LCBAF 8018 | 80 | 77,5 ÷ 79 | 571,00 | 1 |
| LCBAF 9018 | 90 | 87,5 ÷ 89 | 606,00 | 1 |
| LCBAF 10018 | 100 | 97,5 ÷ 99 | 645,00 | 1 |

Profilo maggiore estensibilità

Wall profile adjustment - Verlängerungsprofil - Profilé pour extension supplémentaire

| Codice - Code <i>Artikel - Article</i> | Formato (cm) - Size <i>Format - Dimension</i> | + cm. | Prezzo (€) - Price <i>Preis - Prix</i> |
|--|---|--------------|--|
| MTP 24 | 4,6 x 210 | 1,5 | 102,00 |

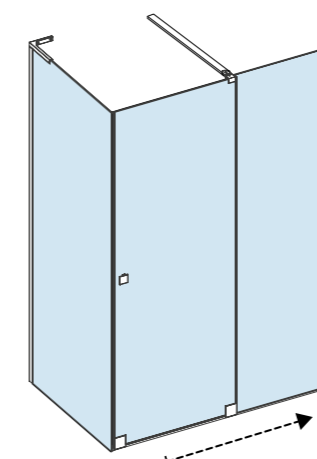
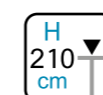

PROFILO A MURO
WALL PROFILE - WANDPROFIL - PROFIL DE MUR

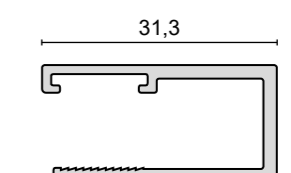

LACUS RIVESTE... SU MISURA - LACUS MAKES IT... TO MEASURE - LACUS FERTIG ...MASSGERECHT - LACUS UNE FABRICATION SUR ...MESURE

Articoli speciali su ordinazione - Special Items on request - Sonderanfertigungen auf Bestellung - Articles 'à la carte' sur commande

| | | |
|--|---|---|
| <p>LATO FISSO - FIXED PANEL FESTE SEITENWAND - PANNEAU FIXE</p> <p>Altezza max 210 cm. - Larghezza max 125 cm. Height max 210 cm. - Width max 125 cm. Maximale Höhe 210 cm. - Maximale Breite 125 cm. Hauteur 210 cm. maximum - Largeur 125 cm. maximum</p> | <p>LATO PORTA DOOR - TÜR - PORTE</p> <p>Altezza max 210 cm. - Larghezza max 180 cm. Height max 210 cm. - Width max 180 cm. Maximale Höhe 210 cm. - Maximale Breite 180 cm. Hauteur 210 cm. maximum - Largeur 180 cm. maximum</p> | <p>VETRO SOPRA MURETTO - GLASS ON THE WALL GLAS AN DER WAND - PAROI SUR MURET</p> <p>NON DISPONIBILE UNAVAILABLE NICHT VERFÜGBAR PAS DISPONIBLE</p> |
|--|---|---|



| | | |
|---|--|--|
| <p>PREZZO DI LISTINO AL PEZZO (TRASPARENTE) GROSS PREIS PRO PIECE (TRANSPARENT) LISTENPREIS PRO STÜCK (TRANSPARENT) PRIX TARIF PAR PIÈCE (TRANSPARENT)</p> | <p>PREVENTIVO SU RICHIESTA PRICE ON REQUEST ANGEBOT AUF ANFRAGE DEVIS SUR DEMANDE</p> | <p>NON DISPONIBILE UNAVAILABLE NICHT VERFÜGBAR PAS DISPONIBLE</p> |
|---|--|--|

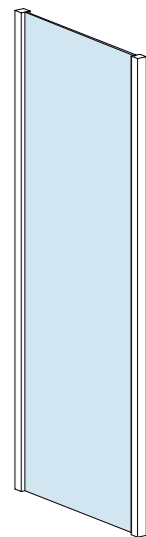

| | |
|---|-----------------|
| <p>FASCIA 1: da 0,01 a 0,50 mq Level 1: from 0.01 to 0.5 sqm</p> | <p>€ 567,00</p> |
| <p>FASCIA 2: da 0,51 a 1,00 mq Level 2: from 0.51 to 1.0 sqm</p> | <p>€ 663,00</p> |
| <p>FASCIA 3: da 1,01 a 1,50 mq Level 3: from 1.01 to 1.5 sqm</p> | <p>€ 786,00</p> |
| <p>FASCIA 4: da 1,51 a 2,00 mq Level 4: from 1.51 to 2.0 sqm</p> | <p>€ 886,00</p> |
| <p>FASCIA 5: da 2,01 a 2,50 mq Level 5: from 2.01 to 2.5 sqm</p> | <p>€ 993,00</p> |

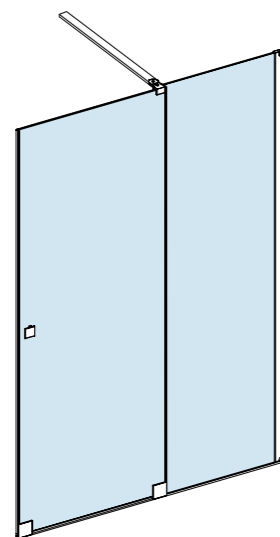

NON DISPONIBILE
UNAVAILABLE
NICHT VERFÜGBAR
PAS DISPONIBLE

Maggiorazione per vetro Matt e Gray: +15%
Surcharge for matt and grey crystal + 15%
Aufpreis für Matt und Grey Kristallglas +15%
Majoration pour les verres Matt e Grey: +15%

ATTENZIONE:
CALCOLARE I MQ. DEL PEZZO PER STABILIRE LA FASCIA DI APPARTENENZA
Per soluzioni diverse da quelle contemplate contattare ns. ufficio tecnico per avere indicazioni di fattibilità e prezzi.

VORSICHT:
BERECHNEN DIE QM. DES STÜCKES, ZUR ERFÜLLUNG DER ZUGEHÖRIGEN BAND
Für andere als die in Betracht gezogenen Lösungen wenden Sie sich an unser technisches Büro, um Informationen zu Machbarkeit und Preisen zu erhalten.

ATTENTION:
CALCULATE THE SQM OF THE ARTIKEL TO ESTABLISH THE BELONGING LEVEL.
For information on feasibility and prices of other solutions, please get in touch with our technical dept.

ATTENTION:
CALCULER LES M². DE LA PAROI POUR ÉTABLIR LA TRANCHE D'APPARTENANCE
Pour d'autres solutions que celles envisagées, contactez notre bureau technique pour connaître la faisabilité et les tarifs.



PROFILO INFERIORE E TERMINALE MAGNETICO
BOTTOM PROFILE AND MAGNETIC TERMINAL
UNTERES PROFIL UND MAGNETISCHER ANSCHLUSS
PROFILÉ INFÉRIEUR ET BORNE MAGNÉTIQUE



BRACCIO SNODABILE
ADJUSTABLE ARM
VERSTELLBARER ARM
BARRE DE RENFORT ARTICULÉE



CARRUCOLA INFERIORE
BOTTOM ROLLER - UNTERE RIEMENSCHLEIBE - ROULETTE INFÉRIEURE



POMOLO
KNOB - KNOPF - POIGNÉE

CARATTERISTICHE GENERALI

- Cristallo temperato da 8 mm.
- Finitura trasparente e specchio.
- Profilo alluminio cromo lucido.
- Chiusura magnetica delle ante.
- Estensione da 1,5 cm.
- Maniglia in ottone cromato.
- Trattamento anticalcare.

GENERAL FEATURES

- Tempered crystal 8 mm.
- Transparent - mirror - crystal.
- Chrome aluminum profile.
- Magnetic waterproof closure.
- Wall profile adjustment 1,5 cm.
- Handle in chromed brass.
- Descaling.

ALLGEMEINE SPEZIFIKATIONEN

- Sekurirkristallglas 8 mm stark.
- Kristallglasfinish: Transparent oder Spiegel.
- Verchromt-Aluminium Profil.
- Magnetverschluss.
- Streckbarkeit 1,5 cm.
- Griff aus verchromten Messing.
- Entkalkungsbehandlung.

SPECIFICATIONS GENERALES

- Verre trempé 8 mm.
- Finition du verre: transparent et miroir.
- Profilé en aluminium chromé.
- Portes à fermeture magnétique.
- Extensibilité 1,5 cm.
- Poignées en laiton chromé.
- Traitement anticalcare.

TRATTAMENTO ANTICALCARE

Descaling
Entkalkungsbehandlung
Traitement anticalcaire



ISCHIA EVO

SOFT CLOSING - CRISTALLO TRASPARENTE

TRANSPARENT CRYSTAL
TRANSPARENTES KRISTALLGLAS
VERRE TRANSPARENT

| CODICE <i>Code - Artikel - Article</i> | Formato (cm) <i>Size - Format - Dimension</i> | Estensibilità <i>Extensibility - Streckbarkeit - Extensibilité</i> | Prezzo (€) <i>Price - Preis - Prix</i> | E <i>cm</i> | Lato porta <i>Door - Tür - Porte</i> |
|---|--|---|---|-----------------------|---|
| LSA EVO 11028 | 110 | 107,4 ÷ 110,4 | 1.056,00 | 45,0 | • |
| LSA EVO 11528 | 115 | 112,4 ÷ 115,4 | 1.067,00 | 47,5 | • |
| LSA EVO 12028 | 120 | 117,4 ÷ 120,4 | 1.078,00 | 50,0 | • |
| LSA EVO 12528 | 125 | 122,4 ÷ 125,4 | 1.150,00 | 52,5 | • |
| LSA EVO 13028 | 130 | 127,4 ÷ 130,4 | 1.189,00 | 55,0 | • |
| LSA EVO 13528 | 135 | 132,4 ÷ 135,4 | 1.225,00 | 57,5 | • |
| LSA EVO 14028 | 140 | 137,4 ÷ 140,4 | 1.237,00 | 60,0 | • |
| LSA EVO 14528 | 145 | 142,4 ÷ 145,4 | 1.273,00 | 62,5 | • |
| LSA EVO 15028 | 150 | 147,4 ÷ 150,4 | 1.275,00 | 65,0 | • |
| LSA EVO 16028 | 160 | 157,4 ÷ 160,4 | 1.333,00 | 70,0 | • |
| LSA EVO 17028 | 170 | 167,4 ÷ 170,4 | 1.345,00 | 75,0 | • |
| LSA EVO 18028 | 180 | 177,4 ÷ 180,4 | 1.417,00 | 80,0 | • |

8 mm
SCORREVOLI
SLIDING

Profilo maggiore estensibilità

Wall profile adjustment - Verlängerungsprofil - Profilé pour extension supplémentaire

| Codice - Code Artikel - Article | Formato (cm) - Size Format - Dimension | + cm. | Prezzo (€) - Price Preis - Prix |
|------------------------------------|---|-------|------------------------------------|
| MTP 11 EVO | 4,3 x 210 | 1,5 | 100,00 |

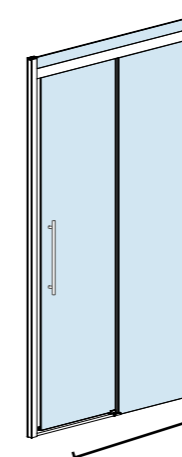
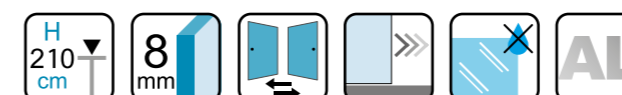

PROFILO A MURO WALL PROFILE - WANDPROFIL - PROFIL DE MUR

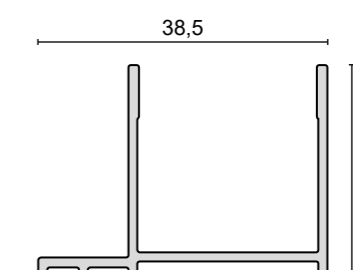

TRATTAMENTO ANTICALCARE

Descaling
Entkalkungsbehandlung
Traitement anticalcaire



ISCHIA EVO

SOFT CLOSING - CRISTALLO TRASPARENTE

TRANSPARENT CRYSTAL
TRANSPARENTES KRISTALLGLAS
VERRE TRANSPARENT

| CODICE <i>Code - Artikel - Article</i> | Formato (cm) <i>Size - Format - Dimension</i> | Estensibilità <i>Extensibility - Streckbarkeit - Extensibilité</i> | Prezzo (€) <i>Price - Preis - Prix</i> | E <i>cm</i> | Lato porta <i>Door - Tür - Porte</i> |
|---|--|---|---|-----------------------|---|
| LSA EVO 11028 | 110 | 107,7 ÷ 110,7 | 1.056,00 | 45,0 | • |
| LSA EVO 11528 | 115 | 112,7 ÷ 115,7 | 1.067,00 | 47,5 | • |
| LSA EVO 12028 | 120 | 117,7 ÷ 120,7 | 1.078,00 | 50,0 | • |
| LSA EVO 12528 | 125 | 122,7 ÷ 125,7 | 1.150,00 | 52,5 | • |
| LSA EVO 13028 | 130 | 127,7 ÷ 130,7 | 1.189,00 | 55,0 | • |
| LSA EVO 13528 | 135 | 132,7 ÷ 135,7 | 1.225,00 | 57,5 | • |
| LSA EVO 14028 | 140 | 137,7 ÷ 140,7 | 1.237,00 | 60,0 | • |
| LSA EVO 14528 | 145 | 142,7 ÷ 145,7 | 1.273,00 | 62,5 | • |
| LSA EVO 15028 | 150 | 147,7 ÷ 150,7 | 1.275,00 | 65,0 | • |
| LSA EVO 16028 | 160 | 157,7 ÷ 160,7 | 1.333,00 | 70,0 | • |
| LSA EVO 17028 | 170 | 167,7 ÷ 170,7 | 1.345,00 | 75,0 | • |
| LSA EVO 18028 | 180 | 177,7 ÷ 180,7 | 1.417,00 | 80,0 | • |

Parete fissa - Pezzi da ordinare
Side - Necessary pieces
Seite - Notwendige Stücke
Paroi fixe - Paroi à commander

| | | | | |
|----------------|-----|-----------|--------|---|
| LSAF EVO 7018 | 70 | 67,5 ÷ 69 | 428,00 | 1 |
| LSAF EVO 7518 | 75 | 72,5 ÷ 74 | 460,00 | 1 |
| LSAF EVO 8018 | 80 | 77,5 ÷ 79 | 463,00 | 1 |
| LSAF EVO 9018 | 90 | 87,5 ÷ 89 | 493,00 | 1 |
| LSAF EVO 10018 | 100 | 97,5 ÷ 99 | 533,00 | 1 |

Profilo maggiore estensibilità

Wall profile adjustment - Verlängerungsprofil - Profilé pour extension supplémentaire

| Codice - Code Artikel - Article | Formato (cm) - Size Format - Dimension | + cm. | Prezzo (€) - Price Preis - Prix |
|------------------------------------|---|------------|------------------------------------|
| MTP 11 EVO | 4,3 x 210 | 1,5 | 100,00 |

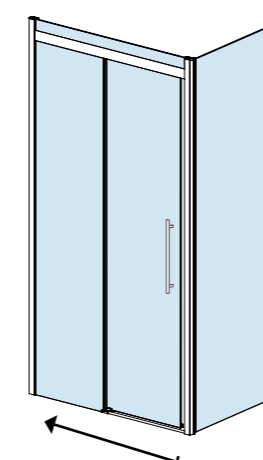
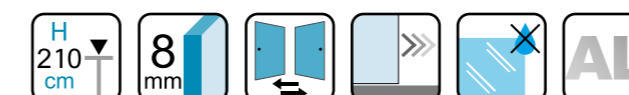

PROFILO A MURO
WALL PROFILE - WANDPROFIL - PROFIL DE MUR

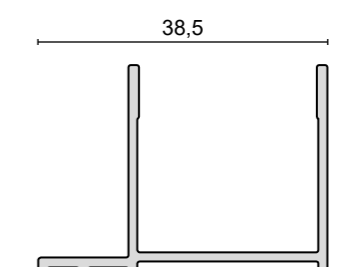

TRATTAMENTO ANTICALCARE

Descaling
Entkalkungsbehandlung
Traitement anticalcaire



ISCHIA EVO

SOFT CLOSING - CRISTALLO TRASPARENTE

TRANSPARENT CRYSTAL
TRANSPARENTES KRISTALLGLAS
VERRE TRANSPARENT

| CODICE <i>Code - Artikel - Article</i> | Formato (cm) <i>Size - Format - Dimension</i> | Estensibilità <i>Extensibility - Streckbarkeit - Extensibilité</i> | Prezzo (€) <i>Price - Preis - Prix</i> | E <i>cm</i> | Lato porta <i>Door - Tür - Porte</i> |
|---|--|---|---|-----------------------|---|
| LSA EVO 11028 | 110 | 108 ÷ 111 | 1.056,00 | 45,0 | • |
| LSA EVO 11528 | 115 | 113 ÷ 116 | 1.067,00 | 47,5 | • |
| LSA EVO 12028 | 120 | 118 ÷ 121 | 1.078,00 | 50,0 | • |
| LSA EVO 12528 | 125 | 123 ÷ 126 | 1.150,00 | 52,5 | • |
| LSA EVO 13028 | 130 | 128 ÷ 131 | 1.189,00 | 55,0 | • |
| LSA EVO 13528 | 135 | 133 ÷ 136 | 1.225,00 | 57,5 | • |
| LSA EVO 14028 | 140 | 138 ÷ 141 | 1.237,00 | 60,0 | • |
| LSA EVO 14528 | 145 | 143 ÷ 146 | 1.273,00 | 62,5 | • |
| LSA EVO 15028 | 150 | 148 ÷ 151 | 1.275,00 | 65,0 | • |
| LSA EVO 16028 | 160 | 158 ÷ 161 | 1.333,00 | 70,0 | • |
| LSA EVO 17028 | 170 | 168 ÷ 171 | 1.345,00 | 75,0 | • |
| LSA EVO 18028 | 180 | 178 ÷ 181 | 1.417,00 | 80,0 | • |

Parete fissa - Pezzi da ordinare
Side - Necessary pieces
Seite - Notwendige Stücke
Paroi fixe - Paroi à commander

| | | | | |
|----------------|-----|-----------|--------|---|
| LSAF EVO 7018 | 70 | 67,5 ÷ 69 | 428,00 | 2 |
| LSAF EVO 7518 | 75 | 72,5 ÷ 74 | 460,00 | 2 |
| LSAF EVO 8018 | 80 | 77,5 ÷ 79 | 463,00 | 2 |
| LSAF EVO 9018 | 90 | 87,5 ÷ 89 | 493,00 | 2 |
| LSAF EVO 10018 | 100 | 97,5 ÷ 99 | 533,00 | 2 |

Profilo maggiore estensibilità

Wall profile adjustment - Verlängerungsprofil - Profilé pour extension supplémentaire

| Codice - Code Artikel - Article | Formato (cm) - Size Format - Dimension | + cm. | Prezzo (€) - Price Preis - Prix |
|------------------------------------|---|-------|------------------------------------|
| MTP 11 EVO | 4,3 x 210 | 1,5 | 100,00 |

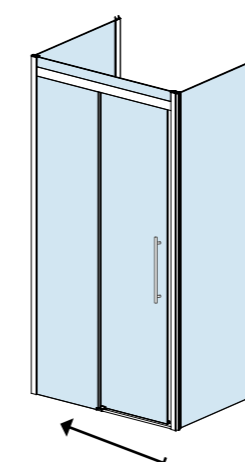
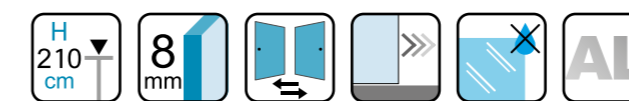

PROFILO A MURO
WALL PROFILE - WANDPROFIL - PROFIL DE MUR

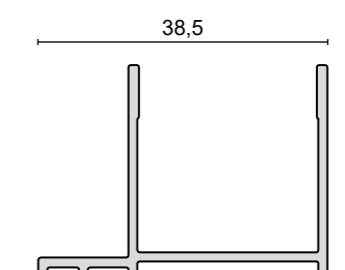

ISCHIA EVO

LACUS RIVESTE... SU MISURA - LACUS MAKES IT... TO MEASURE - LACUS FERTIG ...MASSGERECHT - LACUS UNE FABRICATION SUR ...MESURE

Articoli speciali su ordinazione - Special Items on request - Sonderanfertigungen auf Bestellung - Articles 'à la carte' sur commande

| LATO FISSO - FIXED PANEL FESTE SEITENWAND - PANNEAU FIXE | LATO PORTA DOOR - TÜR - PORTE | VETRO SOPRA MURETTO - GLASS ON THE WALL GLAS AN DER WAND - PAROI SUR MURET |
|---|---|---|
| Altezza max 210 cm. - Larghezza max 125 cm. Height max 210 cm. - Width max 125 cm. Maximale Höhe 210 cm. - Maximale Breite 125 cm. Hauteur 210 cm. maximum - Largeur 125 cm. maximum | Altezza max 210 cm. - Larghezza max/min 180/110 cm. Height max 210 cm. - Width max/min 180/110 cm. Maximale Höhe 210 cm. - Maximale/minimal Breite 180/110 cm. Hauteur 210 cm. maximum - Largeur 180/110 cm. max/min | NON DISPONIBILE UNAVAILABLE NICHT VERFÜGBAR PAS DISPONIBLE |



| PREZZO DI LISTINO AL PEZZO (TRASPARENTE) GROSS PREIS PRO PIECE (TRANSPARENT) LISTENPREIS PRO STÜCK (TRANSPARENT) PRIX TARIF PAR PIÈCE (TRANSPARENT) | PREVENTIVO SU RICHIESTA PRICE ON REQUEST ANGEBOT AUF ANFRAGE DEVIS SUR DEMANDE | NON DISPONIBILE UNAVAILABLE NICHT VERFÜGBAR PAS DISPONIBLE |
|--|---|---|
|--|---|---|

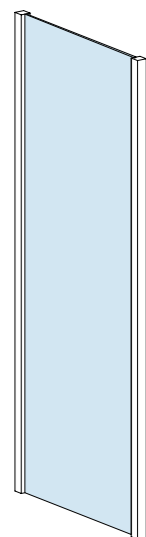

FASCIA 1:
da 0,01 a 0,50 mq
Level 1:
from 0.01 to 0.5 sqm

€ 550,00

FASCIA 2:
da 0,51 a 1,00 mq
Level 2:
from 0.51 to 1.0 sqm

€ 652,00

FASCIA 3:
da 1,01 a 1,50 mq
Level 3:
from 1.01 to 1.5 sqm

€ 771,00

FASCIA 4:
da 1,51 a 2,00 mq
Level 4:
from 1.51 to 2.0 sqm

€ 877,00

FASCIA 5:
da 2,01 a 2,50 mq
Level 5:
from 2.01 to 2.5 sqm

€ 982,00

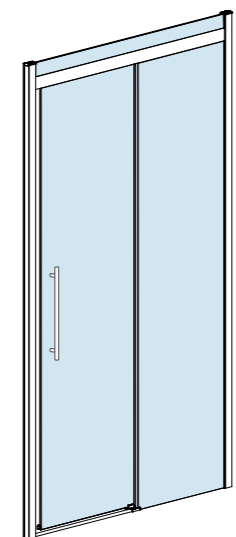

NON DISPONIBILE
UNAVAILABLE
NICHT VERFÜGBAR
PAS DISPONIBLE

Maggiorazione per vetro Matt e Gray: +15%
Surcharge for matt and grey crystal + 15%
Aufpreis für Matt und Grey Kristallglas +15%
Majoration pour les verres Matt e Grey: +15%

ATTENZIONE:

CALCOLARE I MQ. DEL PEZZO PER STABILIRE LA FASCIA DI APPARTENENZA
Per soluzioni diverse da quelle contemplate contattare ns. ufficio tecnico per avere indicazioni di fattibilità e prezzi.

VORSICHT:

BERECHNEN DIE QM. DES STÜCKES, ZUR ERFÜLLUNG DER ZUGEHÖRIGEN BAND
Für andere als die in Betracht gezogenen Lösungen wenden Sie sich an unser technisches Büro, um Informationen zu Machbarkeit und Preisen zu erhalten.

ATTENTION:

CALCULATE THE SQM OF THE ARTIKEL TO ESTABLISH THE BELONGING LEVEL.
For information on feasibility and prices of other solutions, please get in touch with our technical dept.

ATTENTION:

CALCULER LES M². DE LA PAROI POUR ÉTABLIR LA TRANCHE D'APPARTENANCE
Pour d'autres solutions que celles envisagées, contactez notre bureau technique pour connaître la faisabilité et les tarifs.

DETTAGLI & CARATTERISTICHE

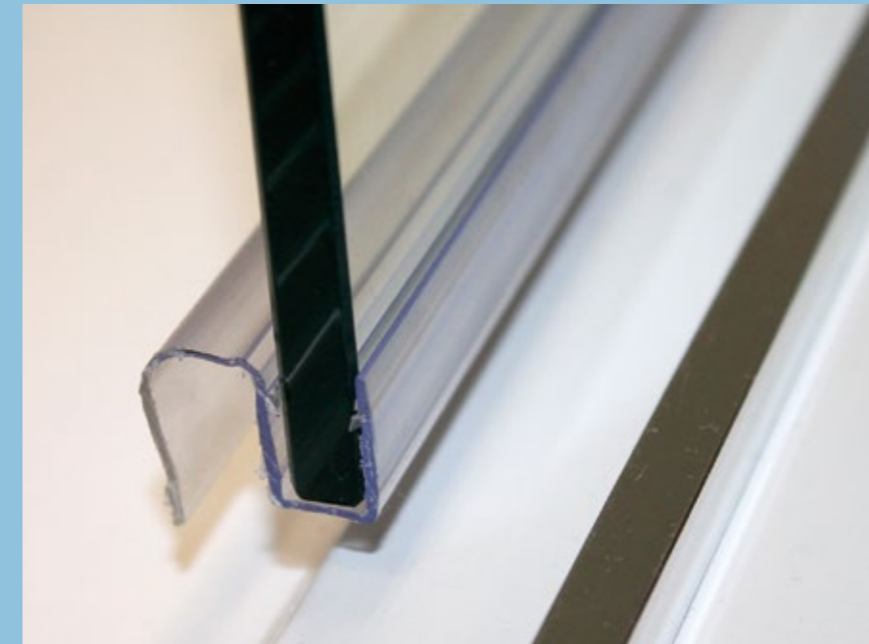

GUARNIZIONE E PROFILO INFERIORE - BOTTOM PROFILE AND GASKET
UNTERES PROFIL - JOINT ET PROFILÉ INFÉRIEURE

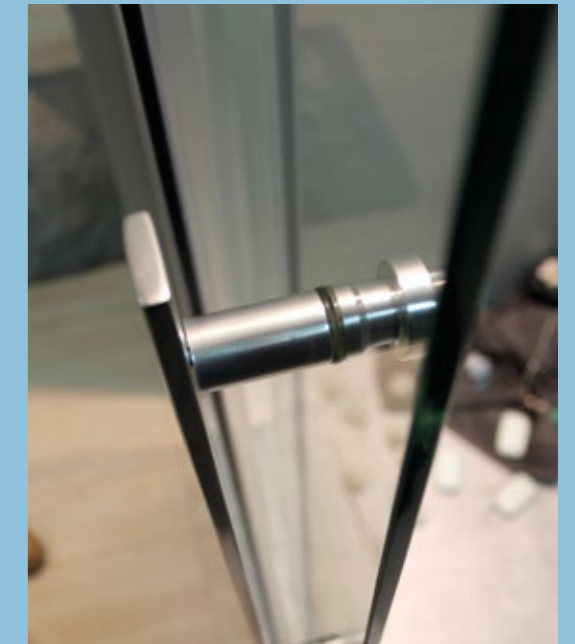

MANIGLIA
HANDLE - GRIFF - POIGNÉ

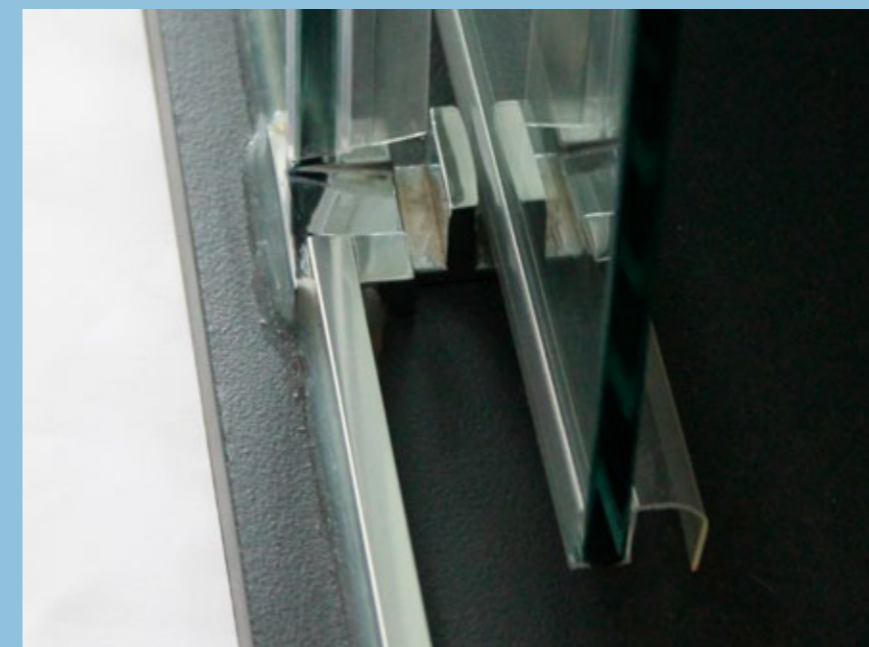

GUIDA INFERIORE
BOTTOM PROFILE - UNTERES PROFIL - PROFILÉ INFÉRIEUR



PROFILO AD ANGOLO - CORNER PROFILE
ECKPROFIL - PROFILÉ D'ANGLE

CARATTERISTICHE GENERALI

- Cristallo temperato da 8 mm.
- Finitura trasparente.
- Profilo alluminio cromo lucido.
- Estensione da 1,5 cm.
- Soft closing.
- Maniglia in alluminio.
- Trattamento anticalcare.

GENERAL FEATURES

- Tempered crystal 8 mm.
- Transparent crystal.
- Chrome aluminum profile.
- Wall profile adjustment 1,5 cm.
- Sliding soft closing.
- Handle in aluminium.
- Descaling.

ALLGEMEINE SPEZIFIKATIONEN

- Sekurirkristallglas 8 mm stark.
- Kristallglasfinish: Transparent.
- Verchromt-Aluminium Profil.
- Streckbarkeit 1,5 cm.
- Selbstschliessende Schiebetür.
- Griff aus Aluminium.
- Entkalkungsbehandlung.

SPECIFICATIONS GENERALES

- Verre trempé 8 mm.
- Finition du verre: transparent.
- Profilé en aluminium chromé.
- Extensibilité 1,5 cm.
- Fermeture de la porte coulissante en douceur (soft closing).
- Poignée en aluminium.
- Traitement anticalcare.

TRATTAMENTO ANTICALCARE

Descaling
Entkalkungsbehandlung
Traitement anticalcaire



LA MADDALENA

ACCIAIO INOX SPAZZOLATO
BRUSHED STAINLESS STEEL
GEBÜRSTETER ROSTFREIER STAHL
ACIER INOXYDABLE BROSSÉ

| CODICE <i>Code - Artikel - Article</i> | Formato (cm) <i>Size - Format - Dimension</i> | Estensibilità <i>Extensibility - Streckbarkeit - Extensibilité</i> | Prezzo (€) <i>Price - Preis - Prix</i> | E <i>cm</i> | Lato porta <i>Door - Tür - Porte</i> |
|--|---|--|--|-----------------------|--|
| LSRAX 12028 | 120 | 117,5 ÷ 119 | 1.450,00 | 53,7 | • |
| LSRAX 13028 | 130 | 127,5 ÷ 129 | 1.500,00 | 58,7 | • |
| LSRAX 14028 | 140 | 137,5 ÷ 139 | 1.540,00 | 63,7 | • |
| LSRAX 15028 | 150 | 147,5 ÷ 149 | 1.582,00 | 68,7 | • |
| LSRAX 16028 | 160 | 157,5 ÷ 159 | 1.628,00 | 73,7 | • |
| LSRAX 17028 | 170 | 167,5 ÷ 169 | 1.661,00 | 78,7 | • |

8 mm
SCORREVOLI
SLIDING

Profilo maggiore estensibilità

Wall profile adjustment - Verlängerungsprofil - Profilé pour extension supplémentaire

| Codice - Code <i>Artikel - Article</i> | Formato (cm) - Size <i>Format - Dimension</i> | + cm. | Prezzo (€) - Price <i>Preis - Prix</i> |
|--|---|--------------|--|
| MTP 22 | 1,5 x 210 | 1,5 | 75,00 |

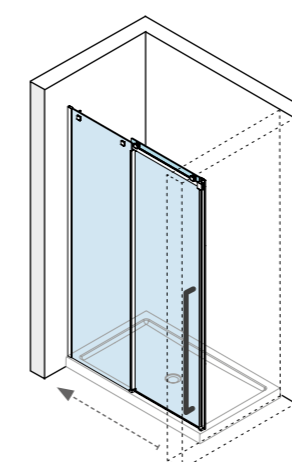
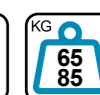
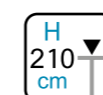

PROFILO A MURO WALL PROFILE - WANDPROFIL - PROFIL DE MUR

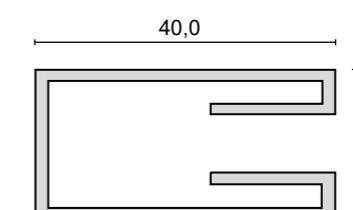

TRATTAMENTO ANTICALCARE

Descaling
Entkalkungsbehandlung
Traitement anticalcaire



LA MADDALENA

ACCIAIO INOX SPAZZOLATO
BRUSHED STAINLESS STEEL
GEBÜRSTETER ROSTFREIER STAHL
ACIER INOXYDABLE BROSSÉ

| CODICE <i>Code - Artikel - Article</i> | Formato (cm) <i>Size - Format - Dimension</i> | Estensibilità <i>Extensibility - Streckbarkeit - Extensibilité</i> | Prezzo (€) <i>Price - Preis - Prix</i> | E <i>cm</i> | Lato porta <i>Door - Tür - Porte</i> |
|---|--|---|---|-----------------------|---|
| LSRAX 12028 | 120 | 117,5 ÷ 119 | 1.450,00 | 53,7 | • |
| LSRAX 13028 | 130 | 127,5 ÷ 129 | 1.500,00 | 58,7 | • |
| LSRAX 14028 | 140 | 137,5 ÷ 139 | 1.540,00 | 63,7 | • |
| LSRAX 15028 | 150 | 147,5 ÷ 149 | 1.582,00 | 68,7 | • |
| LSRAX 16028 | 160 | 157,5 ÷ 159 | 1.628,00 | 73,7 | • |
| LSRAX 17028 | 170 | 167,5 ÷ 169 | 1.661,00 | 78,7 | • |

Parete fissa - Pezzi da ordinare
Side - Necessary pieces
Seite - Notwendige Stücke
Paroi fixe - Paroi à commander

| | | | | |
|--------------|-----|-----------|--------|---|
| LSRAXF 7018 | 70 | 67,5 ÷ 69 | 631,00 | 1 |
| LSRAXF 8018 | 80 | 77,5 ÷ 79 | 673,00 | 1 |
| LSRAXF 9018 | 90 | 87,5 ÷ 89 | 715,00 | 1 |
| LSRAXF 10018 | 100 | 97,5 ÷ 99 | 754,00 | 1 |

Profilo maggiore estensibilità

Wall profile adjustment - Verlängerungsprofil - Profilé pour extension supplémentaire

| Codice - Code <i>Artikel - Article</i> | Formato (cm) - Size <i>Format - Dimension</i> | + cm. | Prezzo (€) - Price <i>Preis - Prix</i> |
|---|--|-------|---|
| MTP 22 | 1,5 x 210 | 1,5 | 75,00 |

8 mm
SCORREVOLI
SLIDING

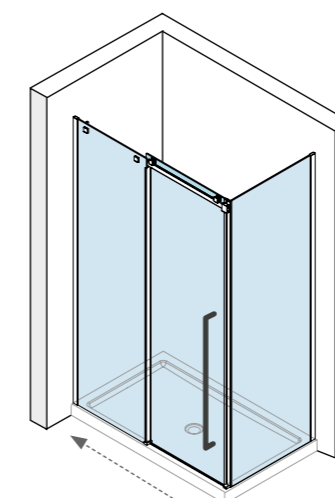

PROFILO A MURO WALL PROFILE - WANDPROFIL - PROFIL DE MUR

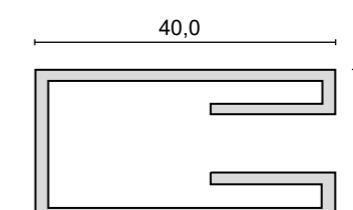

LA MADDALENA

LACUS RIVESTE... SU MISURA - LACUS MAKES IT... TO MEASURE - LACUS FERTIG ...MASSGERECHT - LACUS UNE FABRICATION SUR ...MESURE

Articoli speciali su ordinazione - Special Items on request - Sonderanfertigungen auf Bestellung - Articles 'à la carte' sur commande

| | | |
|---|---|---|
| LATO FISSO - FIXED PANEL FESTE SEITENWAND - PANNEAU FIXE | LATO PORTA DOOR - TÜR - PORTE | VETRO SOPRA MURETTO - GLASS ON THE WALL GLAS AN DER WAND - PAROI SUR MURET |
| Altezza max 210 cm. - Larghezza max 125 cm. Height max 210 cm. - Width max 125 cm. Maximale Höhe 210 cm. - Maximale Breite 125 cm. Hauteur 210 cm. maximum - Largeur 125 cm. maximum | Altezza max 210 cm. - Larghezza max 180 cm. Height max 210 cm. - Width max 180 cm. Maximale Höhe 210 cm. - Maximale Breite 180 cm. Hauteur 210 cm. maximum - Largeur 180 cm. maximum | NON DISPONIBILE UNAVAILABLE NICHT VERFÜGBAR PAS DISPONIBLE |



| | | |
|---|--|---|
| PREZZO DI LISTINO AL PEZZO (TRASPARENTE) GROSS PREIS PRO PIECE (TRANSPARENT) LISTENPREIS PRO STÜCK (TRANSPARENT) PRIX TARIF PAR PIÉCE (TRANSPARENT) | PREVENTIVO SU RICHIESTA PRICE ON REQUEST ANGEBOT AUF ANFRAGE DEVIS SUR DEMANDE | NON DISPONIBILE UNAVAILABLE NICHT VERFÜGBAR PAS DISPONIBLE |
|---|--|---|

| | | |
|--|---|------------|
| | FASCIA 1: da 0,01 a 0,50 mq Level 1: from 0.01 to 0.5 sqm | € 676,00 |
| | FASCIA 2: da 0,51 a 1,00 mq Level 2: from 0.51 to 1.0 sqm | € 777,00 |
| | FASCIA 3: da 1,01 a 1,50 mq Level 3: from 1.01 to 1.5 sqm | € 896,00 |
| | FASCIA 4: da 1,51 a 2,00 mq Level 4: from 1.51 to 2.0 sqm | € 1.001,00 |
| | FASCIA 5: da 2,01 a 2,50 mq Level 5: from 2.01 to 2.5 sqm | € 1.017,00 |

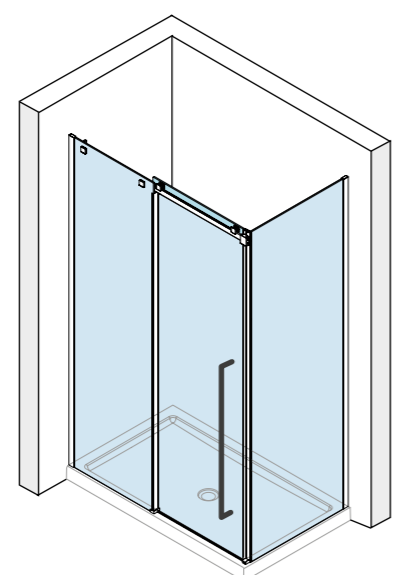

| |
|---|
| NON DISPONIBILE UNAVAILABLE NICHT VERFÜGBAR PAS DISPONIBLE |
| NON DISPONIBILE UNAVAILABLE NICHT VERFÜGBAR PAS DISPONIBLE |

Maggiorazione per vetro Matt e Gray: +15%
 Surcharge for matt and grey crystal + 15%
 Aufpreis für Matt und Grey Kristallglas +15%
 Majoration pour les verres Matt e Grey: +15%

ATTENZIONE:
CALCOLARE I MQ. DEL PEZZO PER STABILIRE LA FASCIA DI APPARTENENZA
 Per soluzioni diverse da quelle contemplate contattare ns. ufficio tecnico per avere indicazioni di fattibilità e prezzi.
VORSICHT:
BERECHNEN DIE QM. DES STÜCKES, ZUR ERFÜLLUNG DER ZUGEHÖRIGEN BAND
 Für andere als die in Betracht gezogenen Lösungen wenden Sie sich an unser technisches Büro, um Informationen zu Machbarkeit und Preisen zu erhalten.

ATTENTION:
CALCULATE THE SQM OF THE ARTIKEL TO ESTABLISH THE BELONGING LEVEL.
 For information on feasibility and prices of other solutions, please get in touch with our technical dept.
ATTENTION:
CALCULER LES M². DE LA PAROI POUR ÉTABLIR LA TRANCHE D'APPARTENANCE
 Pour d'autres solutions que celles envisagées, contactez notre bureau technique pour connaître la faisabilité et les tarifs.

DETTAGLI



CARRUCOLA
 ROLLER - RIEMENSCHLEIBE - ROULETTE



GUARNIZIONE A PALLONCINO - BUBBLE GASKET
 WEICHE RUNDE LIPPENDICHTUNG - JOINT DE BALLON

CARATTERISTICHE GENERALI

- Cristallo temperato da 8 mm.
- Finitura trasparente.
- Profilo in acciaio inox spazzolato.
- Chiusura magnetica delle ante.
- Sistema di sgancio rapido.
- Estensione da 1,5 cm.
- Maniglia in ottone cromato.
- Trattamento anticalcare.

GENERAL FEATURES

- Tempered crystal 8 mm.
- Transparent crystal.
- Brushed stainless steel profil.
- Magnetic waterproof clousure.
- Opening clips for easy cleaning.
- Wall profile adjustment 1,5 cm.
- Handles in chromed brass.
- Descaling.

ALLGEMEINE SPEZIFIKATIONEN

- Sekurirkristallglas 8 mm stark.
- Kristallglasfinish: Transparent.
- Gebürsteter Edelstahl Profil.
- Magnetverschluss.
- Lösbare Tür zur Kristallreinigung.
- Streckbarkeit 1,5 cm.
- Griff aus verchromten Messing.
- Entkalkungsbehandlung.

SPECIFICATIONS GENERALES

- Verre trempé 8 mm.
- Finition du verre: transparent.
- Profilé en acier brossé.
- Portes à fermeture magnétique.
- Portes déclipantes dans la partie basse pour le nettoyage du verre.
- Extensibilité 1,5 cm.
- Poignées en laiton chromé.
- Traitement anticalcaire.

8 mm
 SCORREVOLI
 SLIDING

TRATTAMENTO ANTICALCARE

Descaling
Entkalkungsbehandlung
Traitement anticalcaire



CAPRERA

CRISTALLO TRASPARENTE
TRANSPARENT CRYSTAL
TRANSPARENTES KRISTALLGLAS
VERRE TRANSPARENT

| CODICE <i>Code - Artikel - Article</i> | Formato (cm) <i>Size - Format - Dimension</i> | Estensibilità <i>Extensibility - Streckbarkeit - Extensibilité</i> | Prezzo (€) <i>Price - Preis - Prix</i> | E <i>cm</i> | Lato porta <i>Door - Tür - Porte</i> |
|--|---|--|--|-----------------------|--|
| LSRA 12028 | 120 | 117,5 ÷ 119 | 1.130,00 | 53,0 | • |
| LSRA 13028 | 130 | 127,5 ÷ 129 | 1.168,00 | 58,0 | • |
| LSRA 14028 | 140 | 137,5 ÷ 139 | 1.212,00 | 63,0 | • |
| LSRA 15028 | 150 | 147,5 ÷ 149 | 1.250,00 | 68,0 | • |
| LSRA 16028 | 160 | 157,5 ÷ 159 | 1.290,00 | 73,0 | • |
| LSRA 17028 | 170 | 167,5 ÷ 169 | 1.323,00 | 73,0 | • |

8 mm
SCORREVOLI
SLIDING

Profilo maggiore estensibilità

Wall profile adjustment - Verlängerungsprofil - Profilé pour extension supplémentaire

| Codice - Code <i>Artikel - Article</i> | Formato (cm) - Size <i>Format - Dimension</i> | + cm. | Prezzo (€) - Price <i>Preis - Prix</i> |
|--|---|--------------|--|
| MTP 21 | 1,5 x 210 | 1,5 | 37,00 |

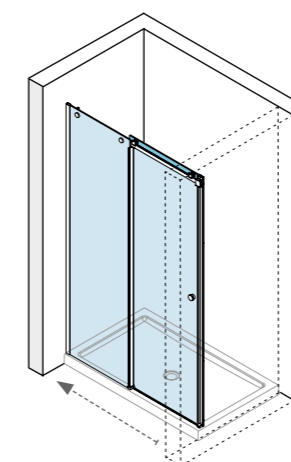

PROFILO A MURO WALL PROFILE - WANDPROFIL - PROFIL DE MUR

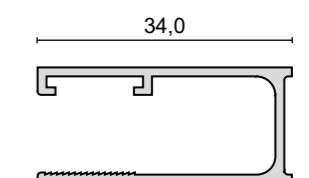

CAPRERA

CRISTALLO TRASPARENTE
 TRANSPARENT CRYSTAL
 TRANSPARENTES KRISTALLGLAS
 VERRE TRANSPARENT



| CODICE <i>Code - Artikel - Article</i> | Formato (cm) <i>Size - Format - Dimension</i> | Estensibilità <i>Extensibility - Streckbarkeit - Extensibilité</i> | Prezzo (€) <i>Price - Preis - Prix</i> | E <i>cm</i> | Lato porta <i>Door - Tür - Porte</i> |
|--|---|--|--|-----------------------|--|
| LSRA 12028 | 120 | 117,5 ÷ 119 | 1.130,00 | 53,0 | • |
| LSRA 13028 | 130 | 127,5 ÷ 129 | 1.168,00 | 58,0 | • |
| LSRA 14028 | 140 | 137,5 ÷ 139 | 1.212,00 | 63,0 | • |
| LSRA 15028 | 150 | 147,5 ÷ 149 | 1.250,00 | 68,0 | • |
| LSRA 16028 | 160 | 157,5 ÷ 159 | 1.290,00 | 73,0 | • |
| LSRA 17028 | 170 | 167,5 ÷ 169 | 1.323,00 | 73,0 | • |

| Parete fissa - Pezzi da ordinare <i>Side - Necessary pieces</i> <i>Seite - Notwendige Stücke</i> <i>Paroi fixe - Paroi à commander</i> | | | | |
|--|-----|-----------|--------|----------|
| LSRAF 7018 | 70 | 67,5 ÷ 69 | 471,00 | 1 |
| LSRAF 8018 | 80 | 77,5 ÷ 79 | 510,00 | 1 |
| LSRAF 9018 | 90 | 87,5 ÷ 89 | 552,00 | 1 |
| LSRAF 10018 | 100 | 97,5 ÷ 99 | 590,00 | 1 |

Profilo maggiore estensibilità

Wall profile adjustment - Verlängerungsprofil - Profilé pour extension supplémentaire

| Codice - Code <i>Artikel - Article</i> | Formato (cm) - Size <i>Format - Dimension</i> | + cm. | Prezzo (€) - Price <i>Preis - Prix</i> |
|--|---|--------------|--|
| MTP 21 | 1,5 x 210 | 1,5 | 37,00 |

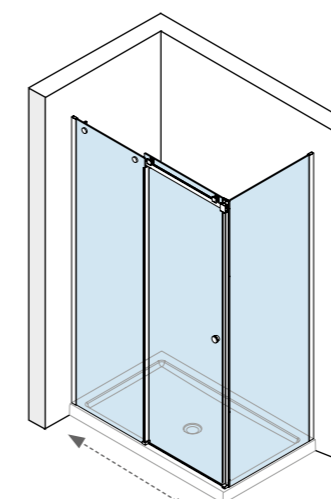

PROFILO A MURO WALL PROFILE - WANDPROFIL - PROFIL DE MUR

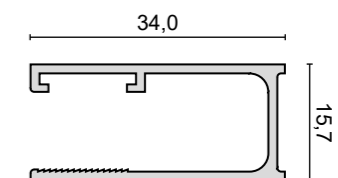

TRATTAMENTO ANTICALCARE

Descaling
Entkalkungsbehandlung
Traitement anticalcaire

LACUS RIVESTE... SU MISURA - LACUS MAKES IT... TO MEASURE - LACUS FERTIG ...MASSGERECHT - LACUS UNE FABRICATION SUR ...MESURE

Articoli speciali su ordinazione - Special Items on request - Sonderanfertigungen auf Bestellung - Articles 'à la carte' sur commande

| LATO FISSO - FIXED PANEL FESTE SEITENWAND - PANNEAU FIXE | LATO PORTA DOOR - TÜR - PORTE | VETRO SOPRA MURETTO - GLASS ON THE WALL GLAS AN DER WAND - PAROI SUR MURET |
|---|---|---|
| Altezza max 210 cm. - Larghezza max 125 cm. Height max 210 cm. - Width max 125 cm. Maximale Höhe 210 cm. - Maximale Breite 125 cm. Hauteur 210 cm. maximum - Largeur 125 cm. maximum | Altezza max 210 cm. - Larghezza max 180 cm. Height max 210 cm. - Width max 180 cm. Maximale Höhe 210 cm. - Maximale Breite 180 cm. Hauteur 210 cm. maximum - Largeur 180 cm. maximum | NON DISPONIBILE UNAVAILABLE NICHT VERFÜGBAR PAS DISPONIBLE |



| PREZZO DI LISTINO AL PEZZO (TRASPARENTE) GROSS PREIS PRO PIECE (TRANSPARENT) LISTENPREIS PRO STÜCK (TRANSPARENT) PRIX TARIF PAR PIÉCE (TRANSPARENT) | PREVENTIVO SU RICHIESTA PRICE ON REQUEST ANGEBOT AUF ANFRAGE DEVIS SUR DEMANDE | NON DISPONIBILE UNAVAILABLE NICHT VERFÜGBAR PAS DISPONIBLE |
|--|---|---|
|--|---|---|

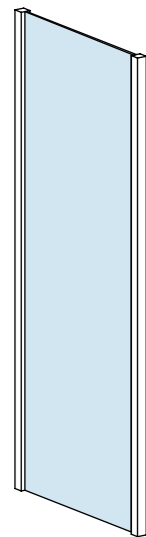

| | |
|---|----------|
| FASCIA 1: da 0,01 a 0,50 mq Level 1: from 0.01 to 0.5 sqm | € 510,00 |
| FASCIA 2: da 0,51 a 1,00 mq Level 2: from 0.51 to 1.0 sqm | € 612,00 |
| FASCIA 3: da 1,01 a 1,50 mq Level 3: from 1.01 to 1.5 sqm | € 735,00 |
| FASCIA 4: da 1,51 a 2,00 mq Level 4: from 1.51 to 2.0 sqm | € 837,00 |
| FASCIA 5: da 2,01 a 2,50 mq Level 5: from 2.01 to 2.5 sqm | € 942,00 |

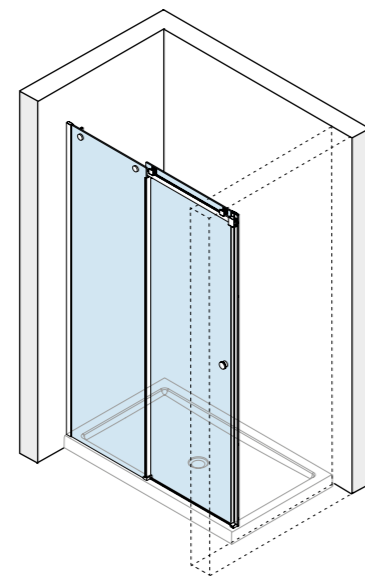

NON DISPONIBILE
UNAVAILABLE
NICHT VERFÜGBAR
PAS DISPONIBLE

Maggiorazione per vetro Matt e Gray: +15%
Surcharge for matt and grey crystal + 15%
Aufpreis für Matt und Grey Kristallglas +15%
Majoration pour les verres Matt e Grey: +15%

ATTENZIONE:
CALCOLARE I MQ. DEL PEZZO PER STABILIRE LA FASCIA DI APPARTENENZA
Per soluzioni diverse da quelle contemplate contattare ns. ufficio tecnico per avere indicazioni di fattibilità e prezzi.
VORSICHT:
BERECHNEN DIE QM. DES STÜCKES, ZUR ERFÜLLUNG DER ZUGEHÖRIGEN BAND
Für andere als die in Betracht gezogenen Lösungen wenden Sie sich an unser technisches Büro, um Informationen zu Machbarkeit und Preisen zu erhalten.

ATTENTION:
CALCULATE THE SQM OF THE ARTIKEL TO ESTABLISH THE BELONGING LEVEL.
For information on feasibility and prices of other solutions, please get in touch with our technical dept.

ATTENTION:
CALCULER LES M². DE LA PAROI POUR ÉTABLIR LA TRANCHE D'APPARTENANCE
Pour d'autres solutions que celles envisagées, contactez notre bureau technique pour connaître la faisabilité et les tarifs.



CARRUCOLA E ANTIJUMP
ROLLER AND ANTIJUMP
RIEMENSCHIBE UND ANTI JUMP
ROULETTE ET ANTIJUMP



GUARNIZIONE A PALLONCINO - BUBBLE GASKET
WEICHE RUNDE LIPPENDICHTUNG - JOINT DE BALLON

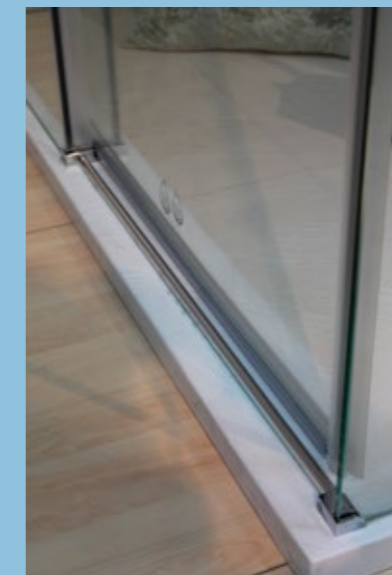

GUARNIZIONE INFERIORE
BOTTOM GASKET
UNTERE DICHTUNG
JOINT INFÉRIEURE



POMOLO
KNOB - KNOPF - POIGNÉE

CARATTERISTICHE GENERALI

- Cristallo temperato da 8 mm.
- Finitura trasparente.
- Profilo alluminio cromo lucido.
- Chiusura magnetica delle ante.
- Estensione da 1,5 cm.
- Pomolo in ottone cromato.
- Trattamento anticalcare.

GENERAL FEATURES

- Tempered crystal 8 mm.
- Transparent crystal.
- Chrome aluminum profile.
- Magnetic waterproof closure.
- Wall profile adjustment 1,5 cm.
- Chromed brass knob.
- Descaling.

ALLGEMEINE SPEZIFIKATIONEN

- Sekurirkristallglas 8 mm stark.
- Kristallglasfinish: Transparent.
- Verchromt-Aluminium- Profil.
- Magnetverschluss.
- Streckbarkeit 1,5 cm.
- Verchromten Messingknopf.
- Entkalkungsbehandlung.

SPECIFICATIONS GENERALES

- Verre trempé 8 mm.
- Finition du verre: transparent.
- Profilé en aluminium chromé.
- Portes à fermeture magnétique.
- Extensibilité 1,5 cm.
- Poignées en laiton chromé.
- Traitement anticalcare.

PANTELLERIA SQUARE

CRISTALLO TRASPARENTE
TRANSPARENT CRYSTAL
TRANSPARENTES KRISTALLGLAS
VERRE TRANSPARENT

| CODICE <i>Code - Artikel - Article</i> | Formato (cm) <i>Size - Format - Dimension</i> | Estensibilità <i>Extensibility - Streckbarkeit - Extensibilité</i> | Prezzo (€) <i>Price - Preis - Prix</i> | E <small>cm</small> | Lato porta <i>Door - Tür - Porte</i> |
|---|--|---|---|-------------------------------|---|
| LDFAS 12028 | 120 | 117,5 ÷ 119 | 1.160,00 | 49,2 | • |
| LDFAS 13028 | 130 | 127,5 ÷ 129 | 1.215,00 | 54,2 | • |
| LDFAS 14028 | 140 | 137,5 ÷ 139 | 1.258,00 | 59,2 | • |
| LDFAS 15028 | 150 | 147,5 ÷ 149 | 1.312,00 | 64,2 | • |
| LDFAS 16028 | 160 | 157,5 ÷ 159 | 1.388,00 | 64,2 | • |
| LDFAS 17028 | 170 | 167,5 ÷ 169 | 1.612,00 | 64,2 | • |

8 mm
SCORREVOLI
SLIDING

Profilo maggiore estensibilità

Wall profile adjustment - Verlängerungsprofil - Profilé pour extension supplémentaire

| Codice - Code Artikel - Article | Formato (cm) - Size Format - Dimension | + cm. | Prezzo (€) - Price Preis - Prix |
|------------------------------------|---|-------|------------------------------------|
| MTP 19 | 4,6 x 210 | 1,5 | 51,00 |

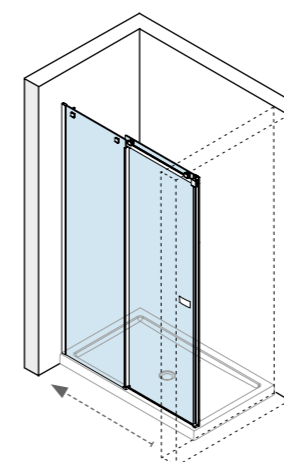

PROFILO A MURO
WALL PROFILE - WANDPROFIL - PROFIL DE MUR

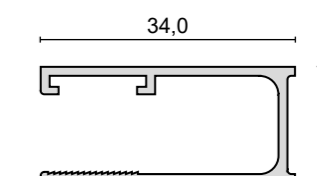

TRATTAMENTO
ANTICALCARE

Descaling
Entkalkungsbehandlung
Traitement anticalcaire



PANTELLERIA SQUARE

CRISTALLO TRASPARENTE
TRANSPARENT CRYSTAL
TRANSPARENTES KRISTALLGLAS
VERRE TRANSPARENT

| CODICE <i>Code - Artikel - Article</i> | Formato (cm) <i>Size - Format - Dimension</i> | Estensibilità <i>Extensibility - Streckbarkeit - Extensibilité</i> | Prezzo (€) <i>Price - Preis - Prix</i> | E <i>cm</i> | Lato porta <i>Door - Tür - Porte</i> |
|---|--|---|---|-----------------------|---|
| LDFAS 12028 | 120 | 117,5 ÷ 119 | 1.160,00 | 49,2 | • |
| LDFAS 13028 | 130 | 127,5 ÷ 129 | 1.215,00 | 54,2 | • |
| LDFAS 14028 | 140 | 137,5 ÷ 139 | 1.258,00 | 59,2 | • |
| LDFAS 15028 | 150 | 147,5 ÷ 149 | 1.312,00 | 64,2 | • |
| LDFAS 16028 | 160 | 157,5 ÷ 159 | 1.388,00 | 64,2 | • |
| LDFAS 17028 | 170 | 167,5 ÷ 169 | 1.612,00 | 64,2 | • |

Parete fissa - Pezzi da ordinare
Side - Necessary pieces
Seite - Notwendige Stücke
Paroi fixe - Pairs à commander

| | | | | |
|------------|----|-----------|--------|---|
| LDFAF 7018 | 70 | 67,5 ÷ 69 | 420,00 | 1 |
| LDFAF 8018 | 80 | 77,5 ÷ 79 | 455,00 | 1 |
| LDFAF 9018 | 90 | 87,5 ÷ 89 | 489,00 | 1 |

Profilo maggiore estensibilità

Wall profile adjustment - Verlängerungsprofil - Profilé pour extension supplémentaire

| Codice - Code Artikel - Article | Formato (cm) - Size Format - Dimension | + cm. | Prezzo (€) - Price Preis - Prix |
|------------------------------------|---|-------|------------------------------------|
| MTP 19 | 4,6 x 210 | 1,5 | 51,00 |

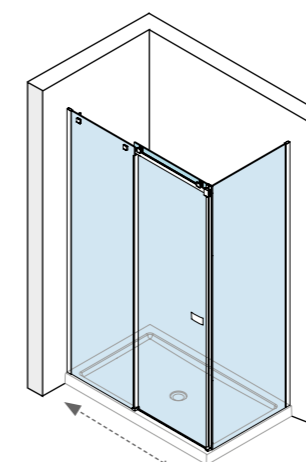

PROFILO A MURO WALL PROFILE - WANDPROFIL - PROFIL DE MUR

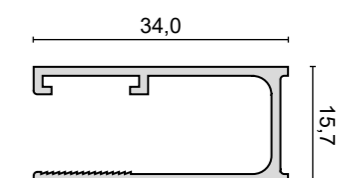

TRATTAMENTO
ANTICALCARE

Descaling
Entkalkungsbehandlung
Traitement anticalcaire

PANTELLERIA ROUND

CRISTALLO TRASPARENTE
TRANSPARENT CRYSTAL
TRANSPARENTES KRISTALLGLAS
VERRE TRANSPARENT

| CODICE <i>Code - Artikel - Article</i> | Formato (cm) <i>Size - Format - Dimension</i> | Estensibilità <i>Extensibility - Streckbarkeit - Extensibilité</i> | Prezzo (€) <i>Price - Preis - Prix</i> | E <small>cm</small> | Lato porta <i>Door - Tür - Porte</i> |
|---|--|---|---|-------------------------------|---|
| LDFAR 12028 | 120 | 117,5 ÷ 119 | 1.160,00 | 49,2 | • |
| LDFAR 13028 | 130 | 127,5 ÷ 129 | 1.215,00 | 54,2 | • |
| LDFAR 14028 | 140 | 137,5 ÷ 139 | 1.258,00 | 59,2 | • |
| LDFAR 15028 | 150 | 147,5 ÷ 149 | 1.312,00 | 64,2 | • |
| LDFAR 16028 | 160 | 157,5 ÷ 159 | 1.388,00 | 64,2 | • |
| LDFAR 17028 | 170 | 167,5 ÷ 169 | 1.612,00 | 64,2 | • |

8
mm
SCORREVOLI
SLIDING

Profilo maggiore estensibilità

Wall profile adjustment - Verlängerungsprofil - Profilé pour extension supplémentaire

| Codice - Code Artikel - Article | Formato (cm) - Size Format - Dimension | + cm. | Prezzo (€) - Price Preis - Prix |
|------------------------------------|---|-------|------------------------------------|
| MTP 19 | 4,6 x 210 | 1,5 | 51,00 |

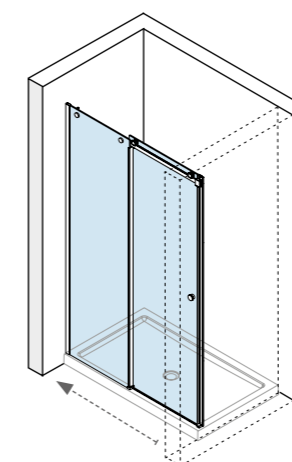

PROFILO A MURO WALL PROFILE - WANDPROFIL - PROFIL DE MUR

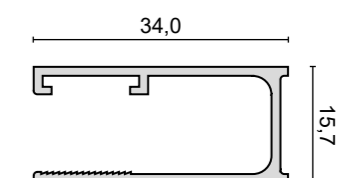

TRATTAMENTO
ANTICALCARE

Descaling
Entkalkungsbehandlung
Traitement anticalcaire



PANTELLERIA ROUND

CRISTALLO TRASPARENTE
TRANSPARENT CRYSTAL
TRANSPARENTES KRISTALLGLAS
VERRE TRANSPARENT

| CODICE <i>Code - Artikel - Article</i> | Formato (cm) <i>Size - Format - Dimension</i> | Estensibilità <i>Extensibility - Streckbarkeit - Extensibilité</i> | Prezzo (€) <i>Price - Preis - Prix</i> | E <i>cm</i> | Lato porta <i>Door - Tür - Porte</i> |
|---|--|---|---|-----------------------|---|
| LDFAR 12028 | 120 | 117,5 ÷ 119 | 1.160,00 | 49,2 | • |
| LDFAR 13028 | 130 | 127,5 ÷ 129 | 1.215,00 | 54,2 | • |
| LDFAR 14028 | 140 | 137,5 ÷ 139 | 1.258,00 | 59,2 | • |
| LDFAR 15028 | 150 | 147,5 ÷ 149 | 1.312,00 | 64,2 | • |
| LDFAR 16028 | 160 | 157,5 ÷ 159 | 1.388,00 | 64,2 | • |
| LDFAR 17028 | 170 | 167,5 ÷ 169 | 1.612,00 | 64,2 | • |

Parete fissa - Pezzi da ordinare
Side - Necessary pieces
Seite - Notwendige Stücke
Paroi fixe - Pairs à commander

| | | | | |
|------------|----|-----------|--------|---|
| LDFAF 7018 | 70 | 67,5 ÷ 69 | 420,00 | 1 |
| LDFAF 8018 | 80 | 77,5 ÷ 79 | 455,00 | 1 |
| LDFAF 9018 | 90 | 87,5 ÷ 89 | 489,00 | 1 |

Profilo maggiore estensibilità

Wall profile adjustment - Verlängerungsprofil - Profilé pour extension supplémentaire

| Codice - Code Artikel - Article | Formato (cm) - Size Format - Dimension | + cm. | Prezzo (€) - Price Preis - Prix |
|------------------------------------|---|-------|------------------------------------|
| MTP 19 | 4,6 x 210 | 1,5 | 51,00 |

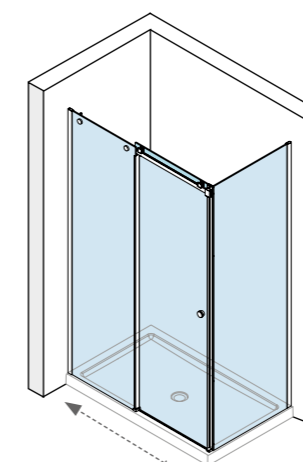

PROFILO A MURO
WALL PROFILE - WANDPROFIL - PROFIL DE MUR

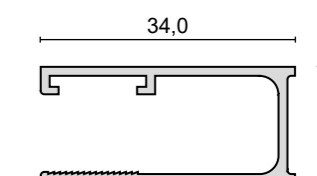

TRATTAMENTO
ANTICALCARE

Descaling
Entkalkungsbehandlung
Traitement anticalcaire

PANTELLERIA

LACUS RIVESTE... SU MISURA - LACUS MAKES IT... TO MEASURE - LACUS FERTIG ...MASSGERECHT - LACUS UNE FABRICATION SUR ...MESURE

Articoli speciali su ordinazione - Special Items on request - Sonderanfertigungen auf Bestellung - Articles 'à la carte' sur commande

| LATO FISSO - FIXED PANEL FESTE SEITENWAND - PANNEAU FIXE | LATO PORTA DOOR - TÜR - PORTE | VETRO SOPRA MURETTO - GLASS ON THE WALL GLAS AN DER WAND - PAROI SUR MURET |
|---|---|---|
| Altezza max 210 cm. - Larghezza max 125 cm. Height max 210 cm. - Width max 125 cm. Maximale Höhe 210 cm. - Maximale Breite 125 cm. Hauteur 210 cm. maximum - Largeur 125 cm. maximum | Altezza max 210 cm. - Larghezza max 180 cm. Height max 210 cm. - Width max 180 cm. Maximale Höhe 210 cm. - Maximale Breite 180 cm. Hauteur 210 cm. maximum - Largeur 180 cm. maximum | |

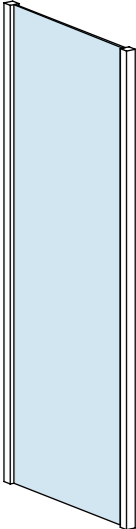
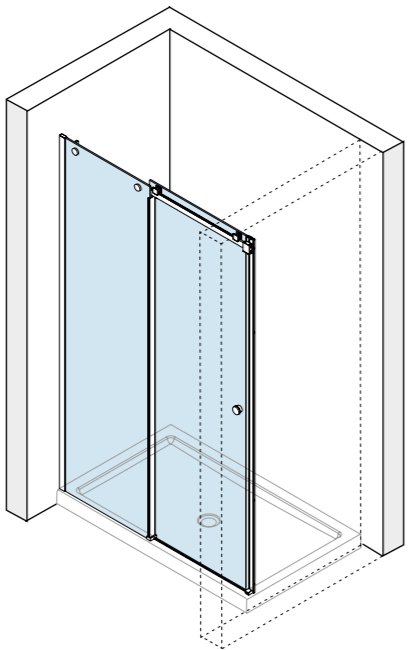
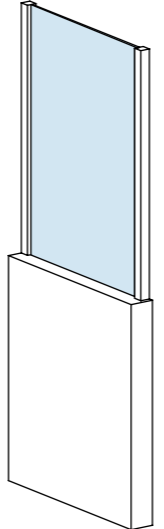

| PREZZO DI LISTINO AL PEZZO (TRASPARENTE) GROSS PREIS PRO PIECE (TRANSPARENT) LISTENPREIS PRO STÜCK (TRANSPARENT) PRIX TARIF PAR PIÈCE (TRANSPARENT) | PREVENTIVO SU RICHIESTA PRICE ON REQUEST ANGEBOT AUF ANFRAGE DEVIS SUR DEMANDE | PREVENTIVO SU RICHIESTA PRICE ON REQUEST ANGEBOT AUF ANFRAGE DEVIS SUR DEMANDE |
|--|---|---|
|--|---|---|

| | | |
|--|--|--|
|  <p>FASCIA 1: da 0,01 a 0,50 mq Level 1: from 0.01 to 0.5 sqm</p> <p>€ 493,00</p> |  |  |
| <p>FASCIA 2: da 0,51 a 1,00 mq Level 2: from 0.51 to 1.0 sqm</p> <p>€ 595,00</p> | | |
| <p>FASCIA 3: da 1,01 a 1,50 mq Level 3: from 1.01 to 1.5 sqm</p> <p>€ 719,00</p> | | |
| <p>FASCIA 4: da 1,51 a 2,00 mq Level 4: from 1.51 to 2.0 sqm</p> <p>€ 825,00</p> | | |
| <p>FASCIA 5: da 2,01 a 2,50 mq Level 5: from 2.01 to 2.5 sqm</p> <p>€ 926,00</p> | | |

Maggiorazione per vetro Matt e Gray: +15%
Surcharge for matt and grey crystal + 15%
Aufpreis für Matt und Grey Kristallglas +15%
Majoration pour les verres Matt e Grey: +15%

ATTENZIONE:

CALCOLARE I MQ. DEL PEZZO PER STABILIRE LA FASCIA DI APPARTENENZA
Per soluzioni diverse da quelle contemplate contattare ns. ufficio tecnico per avere indicazioni di fattibilità e prezzi.

VORSICHT:

BERECHNEN DIE QM. DES STÜCKES, ZUR ERFÜLLUNG DER ZUGEHÖRIGEN BAND
Für andere als die in Betracht gezogenen Lösungen wenden Sie sich an unser technisches Büro, um Informationen zu Machbarkeit und Preisen zu erhalten.

ATTENTION:

CALCULATE THE SQM OF THE ARTIKEL TO ESTABLISH THE BELONGING LEVEL.
For information on feasibility and prices of other solutions, please get in touch with our technical dept.

ATTENTION:

CALCULER LES M². DE LA PAROI POUR ÉTABLIR LA TRANCHE D'APPARTENANCE
Pour d'autres solutions que celles envisagées, contactez notre bureau technique pour connaître la faisabilité et les tarifs.

DETTAGLI & CARATTERISTICHE



POMOLO SQUARE
SQUARE KNOB
VIERECKIGER KNOPF
POIGNÉE CARRÉ

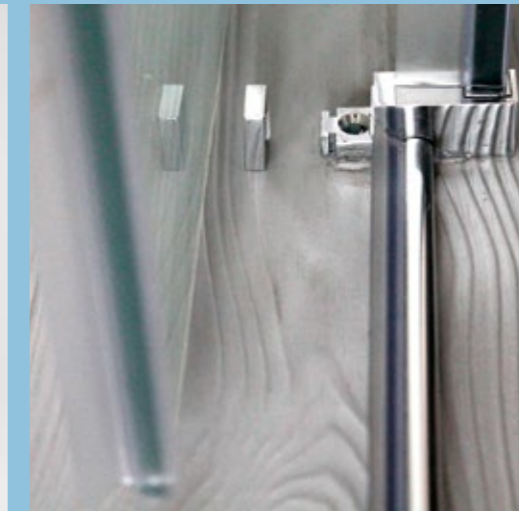

SGANCIO RAPIDO
OPENING CLIPS
LÖSBARE TÜR
PORTE DÉCLIPSANTES

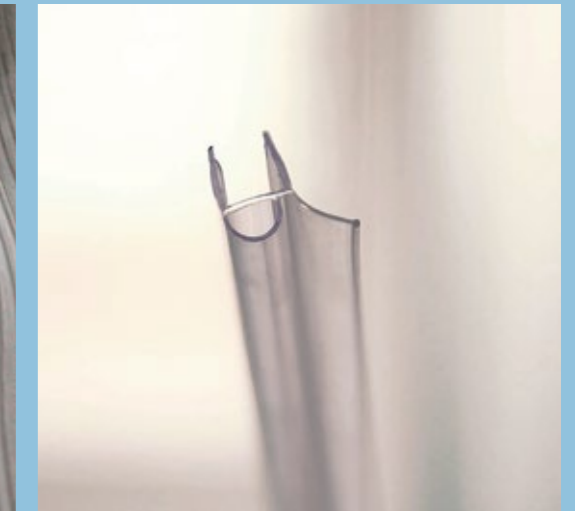

GUARNIZIONE A PALLONCINO
BUBBLE GASKET
WEICHE RUNDE LIPPENDICHTUNG
JOINT DE BALLON



SCATOLA POMOLO ROUND - ROUND KNOB BOX
BOX MIT RUNDER KNOPF - BOÎTE DE POIGNÉE RONDE

CARATTERISTICHE GENERALI

- Cristallo temperato da 8 mm.
- Finitura trasparente.
- Profilo alluminio cromo lucido.
- Chiusura magnetica delle ante.
- Sistema di sgancio rapido
- Estensione da 1,5 cm.
- Pomolo in ottone cromato.
- Trattamento anticalcare.

GENERAL FEATURES

- Tempered crystal 8 mm.
- Transparent - crystal.
- Chrome aluminum profile.
- Magnetic waterproof closure.
- Opening clips.
- Wall profile adjustment 1,5 cm.
- Chromed brass knob.
- Descaling.

ALLGEMEINE SPEZIFIKATIONEN

- Sekurirkristallglas 8 mm stark.
- Kristallglasfinish: Transparent.
- Verchromt-Aluminium Profil.
- Magnetverschluss.
- Lösbare Tür.
- Streckbarkeit 1,5 cm.
- Griff aus verchromtem Messing.
- Entkalkungsbehandlung.

SPECIFICATIONS GENERALES

- Verre trempé 8 mm.
- Finition du verre: transparent.
- Profilé en aluminium chromé.
- Portes à fermeture magnétique.
- Porte déclipantes.
- Extensibilité 1,5 cm.
- Poignées en laiton chromé.
- Traitement anticalcare.

8 mm
SCORREVOLI
SLIDING



6
mm
SCORREVOLI
SLIDING

TRATTAMENTO ANTICALCARE

Descaling
Entkalkungsbehandlung
Traitement anticalcaire

TORCELLO GOLD ROSE

PROFILO ORO ROSA SPAZZOLATO - CRISTALLO TRASPARENTE

BRUSHED GOLD ROSE PROFILE - TRANSPARENT CRYSTAL
GEBÜRSTETER GOLD ROSÉ PROFIL - TRANSPARENTES KRISTALLGLAS
PROFILÉ OR ROSÉ BROSSÉ - VERRRE TRANSPARENT

| CODICE <i>Code - Artikel - Article</i> | Formato (cm) <i>Size - Format - Dimension</i> | Estensibilità <i>Extensibility - Streckbarkeit - Extensibilité</i> | Prezzo (€) <i>Price - Preis - Prix</i> | E <i>cm</i> | Lato porta <i>Door - Tür - Porte</i> |
|---|--|---|---|-----------------------|---|
| LPST 10026GR | 100 | 97 ÷ 100 | 590,00 | 40,5 | • |
| LPST 11026GR | 110 | 107 ÷ 110 | 623,00 | 45,5 | • |
| LPST 12026GR | 120 | 117 ÷ 120 | 656,00 | 50,5 | • |
| LPST 13026GR | 130 | 127 ÷ 130 | 688,00 | 55,5 | • |
| LPST 14026GR | 140 | 137 ÷ 140 | 721,00 | 60,5 | • |
| LPST 15026GR | 150 | 147 ÷ 150 | 753,00 | 65,5 | • |
| LPST 16026GR | 160 | 157 ÷ 160 | 799,00 | 70,5 | • |

6 mm
SCORREVOLI
SLIDING

PROFILO MAGGIORE ESTENSIBILITÀ

Wall profile adjustment - Verlängerungsprofil - Profilé pour extension supplémentaire

| Codice - Code Artikel - Article | Formato (cm) - Size Format - Dimension | + cm. | Prezzo (€) - Price Preis - Prix |
|------------------------------------|---|-------|------------------------------------|
| MTP 28GR | 4,2 x 200 | 1,5 | 64,00 |

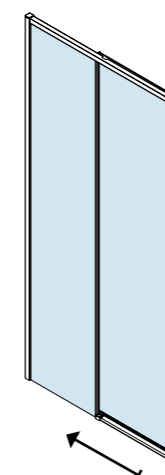

PROFILO A MURO LATO PORTA
WALL PROFILE FOR DOOR
WANDPROFIL FÜR TÜRSEITE
PROFIL DE MUR COTE PORTE

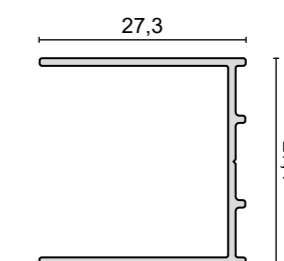

TRATTAMENTO ANTICALCARE

Descaling
Entkalkungsbehandlung
Traitement anticalcaire

TORCELLO GOLD ROSE

PROFILO ORO ROSA SPAZZOLATO - CRISTALLO TRASPARENTE
BRUSHED GOLD ROSE PROFILE - TRANSPARENT CRYSTAL
GEBÜRSTETER GOLD ROSÉ PROFIL - TRANSPARENTES KRISTALLGLAS
PROFILÉ OR ROSÉ BROSSÉ - VERRRE TRANSPARENT

| CODICE Code - Artikel - Article | Formato (cm) Size - Format - Dimension | Estensibilità Extensibility - Streckbarkeit - Extensibilité | Prezzo (€) Price - Preis - Prix | E cm | Lato porta Door - Tür - Porte |
|---|--|---|---|----------------|---|
| LPST 10026GR | 100 | 97 ÷ 100 | 590,00 | 40,5 | • |
| LPST 11026GR | 110 | 107 ÷ 110 | 623,00 | 45,5 | • |
| LPST 12026GR | 120 | 117 ÷ 120 | 656,00 | 50,5 | • |
| LPST 13026GR | 130 | 127 ÷ 130 | 688,00 | 55,5 | • |
| LPST 14026GR | 140 | 137 ÷ 140 | 721,00 | 60,5 | • |
| LPST 15026GR | 150 | 147 ÷ 150 | 753,00 | 65,5 | • |
| LPST 16026GR | 160 | 157 ÷ 160 | 799,00 | 70,5 | • |

Parete fissa - Pezzi da ordinare
Side - Necessary pieces
Seite - Notwendige Stücke
Paroi fixe - Paroi à commander

| | | | | | |
|--------------|----|-----------|--------|--|---|
| LPMTF 7016GR | 70 | 67,5 ÷ 69 | 329,00 | | 1 |
| LPMTF 7516GR | 75 | 72,5 ÷ 74 | 351,00 | | 1 |
| LPMTF 8016GR | 80 | 77,5 ÷ 79 | 373,00 | | 1 |
| LPMTF 9016GR | 90 | 87,5 ÷ 89 | 405,00 | | 1 |

PROFILO MAGGIORE ESTENSIBILITÀ PER LATO PORTA

Wall profile adjustment for door - Verlängerungsprofil für Türseite - Profilé pour extension supplémentaire coté porte

| Codice - Code Artikel - Article | Formato (cm) - Size Format - Dimension | + cm. | Prezzo (€) - Price Preis - Prix |
|---|--|--------------|---|
| MTP 28GR | 4,2 x 200 | 1,5 | 64,00 |

PROFILO MAGGIORE ESTENSIBILITÀ PER LATO FISSO

Wall profile adjustment for side - Verlängerungsprofil für Seitenwand
Profilé pour extension supplémentaire de la paroi fixe

| Codice - Code Artikel - Article | Formato (cm) - Size Format - Dimension | + cm. | Prezzo (€) - Price Preis - Prix |
|---|--|--------------|---|
| MTP 29GR | 4,6 x 200 | 1,5 | 64,00 |

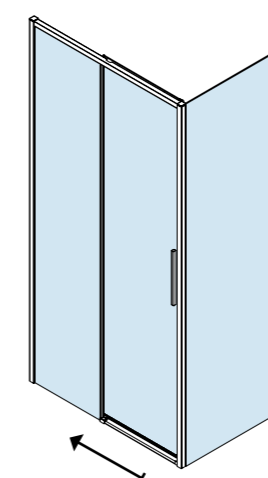

PROFILO A MURO LATO PORTA
WALL PROFILE FOR DOOR
WANDPROFIL FÜR TÜRSEITE
PROFIL DE MUR COTE PORTE

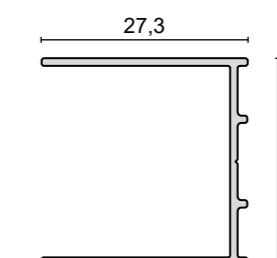

PROFILO A MURO LATO FISSO
WALL PROFILE SIDE PANEL
WANDPROFIL FÜR SEITENWAND
PROFIL DE MUR LATÉRAL FIXE

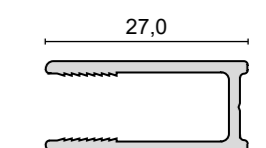

TRATTAMENTO ANTICALCARE

Descaling
Entkalkungsbehandlung
Traitement anticalcaire

TORCELLO GOLD ROSE

PROFILO ORO ROSA SPAZZOLATO - CRISTALLO TRASPARENTE
BRUSHED GOLD ROSE PROFILE - TRANSPARENT CRYSTAL
GEBÜRSTETER GOLD ROSÉ PROFIL - TRANSPARENTES KRISTALLGLAS
PROFILÉ OR ROSÉ BROSSÉ - VERRRE TRANSPARENT

| CODICE <i>Code - Artikel - Article</i> | Formato (cm) <i>Size - Format - Dimension</i> | Estensibilità <i>Extensibility - Streckbarkeit - Extensibilité</i> | Prezzo (€) <i>Price - Preis - Prix</i> | E <i>cm</i> | Lato porta <i>Door - Tür - Porte</i> |
|---|--|---|---|-----------------------|---|
| LPST 10026GR | 100 | 97 ÷ 100 | 590,00 | 40,5 | • |
| LPST 11026GR | 110 | 107 ÷ 110 | 623,00 | 45,5 | • |
| LPST 12026GR | 120 | 117 ÷ 120 | 656,00 | 50,5 | • |
| LPST 13026GR | 130 | 127 ÷ 130 | 688,00 | 55,5 | • |
| LPST 14026GR | 140 | 137 ÷ 140 | 721,00 | 60,5 | • |
| LPST 15026GR | 150 | 147 ÷ 150 | 753,00 | 65,5 | • |
| LPST 16026GR | 160 | 157 ÷ 160 | 799,00 | 70,5 | • |

Parete fissa - Pezzi da ordinare
Side - Necessary pieces
Seite - Notwendige Stücke
Paroi fixe - Paroi à commander

| | | | | | |
|--------------|----|-----------|--------|--|---|
| LPMTF 7016GR | 70 | 67,5 ÷ 69 | 329,00 | | 2 |
| LPMTF 7516GR | 75 | 72,5 ÷ 74 | 351,00 | | 2 |
| LPMTF 8016GR | 80 | 77,5 ÷ 79 | 373,00 | | 2 |
| LPMTF 9016GR | 90 | 87,5 ÷ 89 | 405,00 | | 2 |

PROFILO MAGGIORE ESTENSIBILITÀ PER LATO FISSO

Wall profile adjustment for side - Verlängerungsprofil für Seitenwand
Profilé pour extension supplémentaire de la paroi fixe

| Codice - Code Artikel - Article | Formato (cm) - Size Format - Dimension | + cm. | Prezzo (€) - Price Preis - Prix |
|------------------------------------|---|-------|------------------------------------|
| MTP 29GR | 4,6 x 200 | 1,5 | 64,00 |

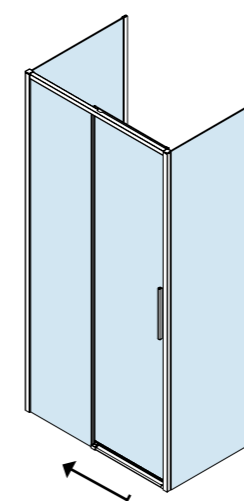

PROFILO A MURO LATO FISSO
WALL PROFILE SIDE PANEL
WANDPROFIL FÜR SEITENWAND
PROFIL DE MUR LATÉRAL FIXE

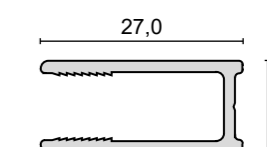

TRATTAMENTO ANTICALCARE

Descaling
Entkalkungsbehandlung
Traitement anticalcaire



TORCELLO

CRISTALLO TRASPARENTE
TRANSPARENT CRYSTAL
TRANSPARENTES KRISTALLGLAS
VERRE TRANSPARENT

| CODICE <i>Code - Artikel - Article</i> | Formato (cm) <i>Size - Format - Dimension</i> | Estensibilità <i>Extensibility - Streckbarkeit - Extensibilité</i> | Prezzo (€) <i>Price - Preis - Prix</i> | E <i>cm</i> | Lato porta <i>Door - Tür - Porte</i> |
|--|---|--|--|-----------------------|--|
| LPST 10026 | 100 | 97 ÷ 100 | 471,00 | 40,5 | • |
| LPST 11026 | 110 | 107 ÷ 110 | 490,00 | 45,5 | • |
| LPST 12026 | 120 | 117 ÷ 120 | 512,00 | 50,5 | • |
| LPST 13026 | 130 | 127 ÷ 130 | 534,00 | 55,5 | • |
| LPST 14026 | 140 | 137 ÷ 140 | 558,00 | 60,5 | • |
| LPST 15026 | 150 | 147 ÷ 150 | 668,00 | 65,5 | • |
| LPST 16026 | 160 | 157 ÷ 160 | 768,00 | 70,5 | • |

6 mm
SCORREVOLI
SLIDING

PROFILO MAGGIORE ESTENSIBILITÀ

Wall profile adjustment - Verlängerungsprofil - Profilé pour extension supplémentaire

| Codice - Code <i>Artikel - Article</i> | Formato (cm) - Size <i>Format - Dimension</i> | + cm. | Prezzo (€) - Price <i>Preis - Prix</i> |
|--|---|--------------|--|
| MTP 28 | 4,2 x 200 | 1,5 | 55,00 |

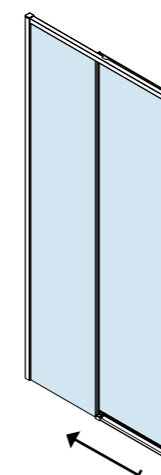

PROFILO A MURO LATO PORTA
WALL PROFILE FOR DOOR
WANDPROFIL FÜR TÜRSEITE
PROFIL DE MUR COTE PORTE

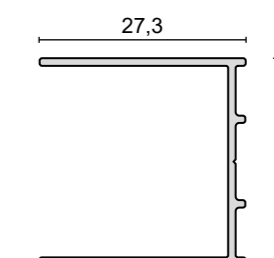

TRATTAMENTO ANTICALCARE

Descaling
Entkalkungsbehandlung
Traitement anticalcaire



TORCELLO

CRISTALLO TRASPARENTE
TRANSPARENT CRYSTAL
TRANSPARENTES KRISTALLGLAS
VERRE TRANSPARENT

| CODICE Code - Artikel - Article | Formato (cm) Size - Format - Dimension | Estensibilità Extensibility - Streckbarkeit - Extensibilité | Prezzo (€) Price - Preis - Prix | E cm | Lato porta Door - Tür - Porte |
|---|--|---|---|----------------|---|
| LPST 10026 | 100 | 97 ÷ 100 | 471,00 | 40,5 | • |
| LPST 11026 | 110 | 107 ÷ 110 | 490,00 | 45,5 | • |
| LPST 12026 | 120 | 117 ÷ 120 | 512,00 | 50,5 | • |
| LPST 13026 | 130 | 127 ÷ 130 | 534,00 | 55,5 | • |
| LPST 14026 | 140 | 137 ÷ 140 | 558,00 | 60,5 | • |
| LPST 15026 | 150 | 147 ÷ 150 | 668,00 | 65,5 | • |
| LPST 16026 | 160 | 157 ÷ 160 | 768,00 | 70,5 | • |

Parete fissa - Pezzi da ordinare
Side - Necessary pieces
Seite - Notwendige Stücke
Paroi fixe - Paroi à commander

| | | | | |
|------------|----|-----------|--------|---|
| LPMTF 7016 | 70 | 67,5 ÷ 69 | 270,00 | 1 |
| LPMTF 7516 | 75 | 72,5 ÷ 74 | 292,00 | 1 |
| LPMTF 8016 | 80 | 77,5 ÷ 79 | 293,00 | 1 |
| LPMTF 9016 | 90 | 87,5 ÷ 89 | 316,00 | 1 |

PROFILO MAGGIORE ESTENSIBILITÀ PER LATO PORTA

Wall profile adjustment for door - Verlängerungsprofil für Türseite - Profilé pour extension supplémentaire

| Codice - Code Artikel - Article | Formato (cm) - Size Format - Dimension | + cm. | Prezzo (€) - Price Preis - Prix |
|---|--|--------------|---|
| MTP 28 | 4,2 x 200 | 1,5 | 55,00 |

PROFILO MAGGIORE ESTENSIBILITÀ PER LATO FISSO

Wall profile adjustment for side - Verlängerungsprofil für Seitenwand
Profilé pour extension supplémentaire de la paroi fixe

| Codice - Code Artikel - Article | Formato (cm) - Size Format - Dimension | + cm. | Prezzo (€) - Price Preis - Prix |
|---|--|--------------|---|
| MTP 29 | 4,6 x 200 | 1,5 | 55,00 |

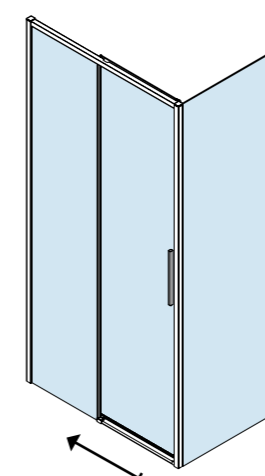

PROFILO A MURO LATO PORTA
WALL PROFILE FOR DOOR
WANDPROFIL FÜR TÜRSEITE
PROFIL DE MUR COTE PORTE

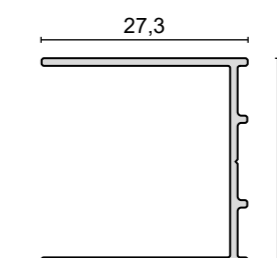

PROFILO A MURO LATO FISSO
WALL PROFILE SIDE PANEL
WANDPROFIL FÜR SEITENWAND
PROFIL DE MUR LATÉRAL FIXE

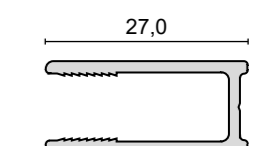

TRATTAMENTO ANTICALCARE

Descaling
Entkalkungsbehandlung
Traitement anticalcaire

TORCELLO

CRISTALLO TRASPARENTE
TRANSPARENT CRYSTAL
TRANSPARENTES KRISTALLGLAS
VERRE TRANSPARENT

| CODICE <i>Code - Artikel - Article</i> | Formato (cm) <i>Size - Format - Dimension</i> | Estensibilità <i>Extensibility - Streckbarkeit - Extensibilité</i> | Prezzo (€) <i>Price - Preis - Prix</i> | E <i>cm</i> | Lato porta <i>Door - Tür - Porte</i> |
|--|---|--|--|-----------------------|--|
| LPST 10026 | 100 | 97 ÷ 100 | 471,00 | 40,5 | • |
| LPST 11026 | 110 | 107 ÷ 110 | 490,00 | 45,5 | • |
| LPST 12026 | 120 | 117 ÷ 120 | 512,00 | 50,5 | • |
| LPST 13026 | 130 | 127 ÷ 130 | 534,00 | 55,5 | • |
| LPST 14026 | 140 | 137 ÷ 140 | 558,00 | 60,5 | • |
| LPST 15026 | 150 | 147 ÷ 150 | 668,00 | 65,5 | • |
| LPST 16026 | 160 | 157 ÷ 160 | 768,00 | 70,5 | • |

Parete fissa - Pezzi da ordinare
Side - Necessary pieces
Seite - Notwendige Stücke
Paroi fixe - Paroi à commander

| | | | | |
|------------|----|-----------|--------|----------|
| LPMTF 7016 | 70 | 67,5 ÷ 69 | 270,00 | 2 |
| LPMTF 7516 | 75 | 72,5 ÷ 74 | 292,00 | 2 |
| LPMTF 8016 | 80 | 77,5 ÷ 79 | 293,00 | 2 |
| LPMTF 9016 | 90 | 87,5 ÷ 89 | 316,00 | 2 |

PROFILO MAGGIORE ESTENSIBILITÀ PER LATO FISSO

Wall profile adjustment for side - Verlängerungsprofil für Seitenwand
Profilé pour extension supplémentaire de la paroi fixe

| Codice - Code <i>Artikel - Article</i> | Formato (cm) - Size <i>Format - Dimension</i> | + cm. | Prezzo (€) - Price <i>Preis - Prix</i> |
|--|---|--------------|--|
| MTP 29 | 4,6 x 200 | 1,5 | 55,00 |

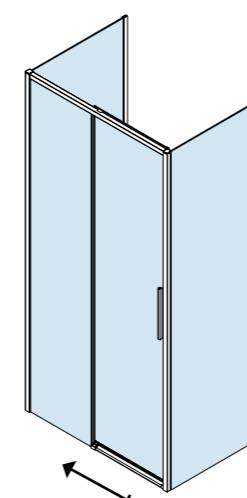

PROFILO A MURO LATO FISSO
WALL PROFILE SIDE PANEL
WANDPROFIL FÜR SEITENWAND
PROFIL DE MUR LATÉRAL FIXE

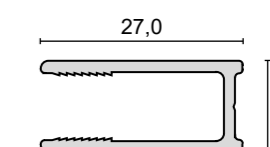

TRATTAMENTO ANTICALCARE

Descaling
Entkalkungsbehandlung
Traitement anticalcaire



TORCELLO BLACK

PROFILO NERO SATINATO - CRISTALLO TRASPARENTE

BLACK SATIN PROFILE - TRANSPARENT CRYSTAL
SCHWARZ-SATINIERTES PROFIL - TRANSPARENTES KRISTALLGLAS
PROFILÉ NOIR SATINÉ - VERRRE TRANSPARENT

| CODICE <i>Code - Artikel - Article</i> | Formato (cm) <i>Size - Format - Dimension</i> | Estensibilità <i>Extensibility - Streckbarkeit - Extensibilité</i> | Prezzo (€) <i>Price - Preis - Prix</i> | E <i>cm</i> | Lato porta <i>Door - Tür - Porte</i> |
|---|--|---|---|-----------------------|---|
| LPST 10026BT | 100 | 97 ÷ 100 | 471,00 | 40,5 | • |
| LPST 11026BT | 110 | 107 ÷ 110 | 490,00 | 45,5 | • |
| LPST 12026BT | 120 | 117 ÷ 120 | 512,00 | 50,5 | • |
| LPST 13026BT | 130 | 127 ÷ 130 | 534,00 | 55,5 | • |
| LPST 14026BT | 140 | 137 ÷ 140 | 558,00 | 60,5 | • |
| LPST 15026BT | 150 | 147 ÷ 150 | 668,00 | 65,5 | • |
| LPST 16026BT | 160 | 157 ÷ 160 | 768,00 | 70,5 | • |

6 mm
SCORREVOLI
SLIDING

PROFILO MAGGIORE ESTENSIBILITÀ

Wall profile adjustment - Verlängerungsprofil - Profilé pour extension supplémentaire

| Codice - Code Artikel - Article | Formato (cm) - Size Format - Dimension | + cm. | Prezzo (€) - Price Preis - Prix |
|------------------------------------|---|-------|------------------------------------|
| MTP 28B | 4,2 x 200 | 1,5 | 55,00 |

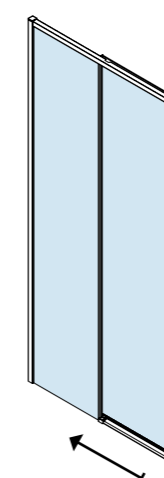

PROFILO A MURO LATO PORTA
WALL PROFILE FOR DOOR
WANDPROFIL FÜR TÜRSEITE
PROFIL DE MUR COTE PORTE

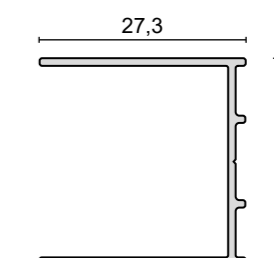

TRATTAMENTO ANTICALCARE

Descaling
Entkalkungsbehandlung
Traitement anticalcaire



TORCELLO BLACK

PROFILO NERO SATINATO - CRISTALLO TRASPARENTE

BLACK SATIN PROFILE - TRANSPARENT CRYSTAL
SCHWARZ-SATINIERTES PROFIL - TRANSPARENTES KRISTALLGLAS
PROFILÉ NOIR SATINÉ - VERRRE TRANSPARENT

| CODICE <i>Code - Artikel - Article</i> | Formato (cm) <i>Size - Format - Dimension</i> | Estensibilità <i>Extensibility - Streckbarkeit - Extensibilité</i> | Prezzo (€) <i>Price - Preis - Prix</i> | E <i>cm</i> | Lato porta <i>Door - Tür - Porte</i> |
|---|--|---|---|-----------------------|---|
| LPST 10026BT | 100 | 97 ÷ 100 | 471,00 | 40,5 | • |
| LPST 11026BT | 110 | 107 ÷ 110 | 490,00 | 45,5 | • |
| LPST 12026BT | 120 | 117 ÷ 120 | 512,00 | 50,5 | • |
| LPST 13026BT | 130 | 127 ÷ 130 | 534,00 | 55,5 | • |
| LPST 14026BT | 140 | 137 ÷ 140 | 558,00 | 60,5 | • |
| LPST 15026BT | 150 | 147 ÷ 150 | 668,00 | 65,5 | • |
| LPST 16026BT | 160 | 157 ÷ 160 | 768,00 | 70,5 | • |

Parete fissa - Pezzi da ordinare
Side - Necessary pieces
Seite - Notwendige Stücke
Paroi fixe - Paroi à commander

| | | | | |
|--------------|----|-----------|--------|---|
| LPMTF 7016BT | 70 | 67,5 ÷ 69 | 270,00 | 1 |
| LPMTF 7516BT | 75 | 72,5 ÷ 74 | 292,00 | 1 |
| LPMTF 8016BT | 80 | 77,5 ÷ 79 | 293,00 | 1 |
| LPMTF 9016BT | 90 | 87,5 ÷ 89 | 316,00 | 1 |

PROFILO MAGGIORE ESTENSIBILITÀ PER LATO PORTA

Wall profile adjustment - Verlängerungsprofil - Profilé pour extension supplémentaire

| Codice - Code Artikel - Article | Formato (cm) - Size Format - Dimension | + cm. | Prezzo (€) - Price Preis - Prix |
|------------------------------------|---|-------|------------------------------------|
| MTP 28B | 4,2 x 200 | 1,5 | 55,00 |

PROFILO MAGGIORE ESTENSIBILITÀ PER LATO FISSO

Wall profile adjustment for side - Verlängerungsprofil für Seitenwand
Profilé pour extension supplémentaire de la paroi fixe

| Codice - Code Artikel - Article | Formato (cm) - Size Format - Dimension | + cm. | Prezzo (€) - Price Preis - Prix |
|------------------------------------|---|-------|------------------------------------|
| MTP 29B | 4,6 x 200 | 1,5 | 55,00 |

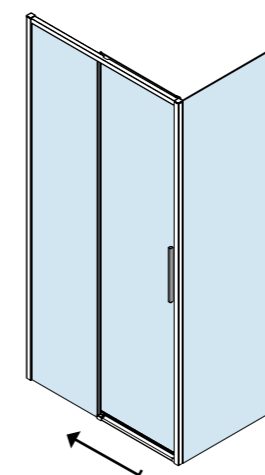

PROFILO A MURO LATO PORTA
WALL PROFILE FOR DOOR
WANDPROFIL FÜR TÜRSEITE
PROFIL DE MUR COTE PORTE

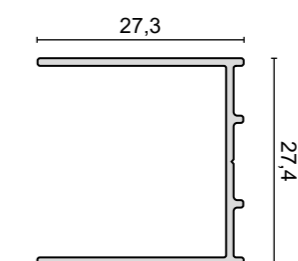

PROFILO A MURO LATO FISSO
WALL PROFILE SIDE PANEL
WANDPROFIL FÜR SEITENWAND
PROFIL DE MUR LATÉRAL FIXE

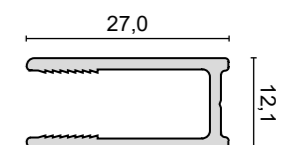

TRATTAMENTO ANTICALCARE

Descaling
Entkalkungsbehandlung
Traitement anticalcaire

TORCELLO BLACK

PROFILO NERO SATINATO - CRISTALLO TRASPARENTE

BLACK SATIN PROFILE - TRANSPARENT CRYSTAL
SCHWARZ-SATINIERTES PROFIL - TRANSPARENTES KRISTALLGLAS
PROFILÉ NOIR SATINÉ - VERRRE TRANSPARENT

| CODICE <i>Code - Artikel - Article</i> | Formato (cm) <i>Size - Format - Dimension</i> | Estensibilità <i>Extensibility - Streckbarkeit - Extensibilité</i> | Prezzo (€) <i>Price - Preis - Prix</i> |  Lato porta <i>Door - Tür - Porte</i> |
|---|--|---|---|--|
| LPST 10026BT | 100 | 97 ÷ 100 | 471,00 | 40,5 • |
| LPST 11026BT | 110 | 107 ÷ 110 | 490,00 | 45,5 • |
| LPST 12026BT | 120 | 117 ÷ 120 | 512,00 | 50,5 • |
| LPST 13026BT | 130 | 127 ÷ 130 | 534,00 | 55,5 • |
| LPST 14026BT | 140 | 137 ÷ 140 | 558,00 | 60,5 • |
| LPST 15026BT | 150 | 147 ÷ 150 | 668,00 | 65,5 • |
| LPST 16026BT | 160 | 157 ÷ 160 | 768,00 | 70,5 • |

Parete fissa - Pezzi da ordinare
Side - Necessary pieces
Seite - Notwendige Stücke
Paroi fixe - Paroi à commander

| | | | | |
|--------------|----|-----------|--------|---|
| LPMTF 7016BT | 70 | 67,5 ÷ 69 | 270,00 | 2 |
| LPMTF 7516BT | 75 | 72,5 ÷ 74 | 292,00 | 2 |
| LPMTF 8016BT | 80 | 77,5 ÷ 79 | 293,00 | 2 |
| LPMTF 9016BT | 90 | 87,5 ÷ 89 | 316,00 | 2 |

PROFILO MAGGIORE ESTENSIBILITÀ PER LATO FISSO

Wall profile adjustment for side - Verlängerungsprofil für Seitenwand
Profilé pour extension supplémentaire de la paroi fixe

| Codice - Code Artikel - Article | Formato (cm) - Size Format - Dimension | + cm. | Prezzo (€) - Price Preis - Prix |
|------------------------------------|---|-------|------------------------------------|
| MTP 29B | 4,6 x 200 | 1,5 | 55,00 |

6 mm
SCORREVOLI
SLIDING

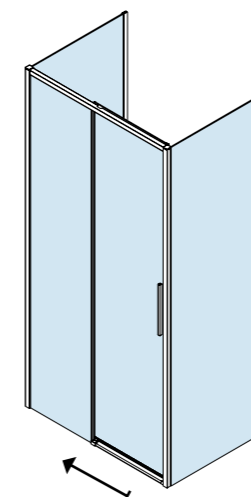

PROFILO A MURO LATO FISSO
WALL PROFILE SIDE PANEL
WANDPROFIL FÜR SEITENWAND
PROFIL DE MUR LATÉRAL FIXE

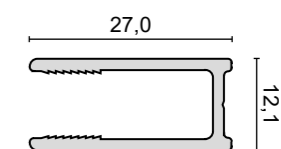

TRATTAMENTO ANTICALCARE

Descaling
Entkalkungsbehandlung
Traitement anticalcaire



TORCELLO WHITE

PROFILO BIANCO SATINATO - CRISTALLO TRASPARENTE

WHITE SATIN PROFILE - TRANSPARENT CRYSTAL
WEISS-SATINIERTES PROFIL - TRANSPARENTES KRISTALLGLAS
PROFILÉ BLANC SATINÉ - VERRE TRANSPARENT

| CODICE <i>Code - Artikel - Article</i> | Formato (cm) <i>Size - Format - Dimension</i> | Estensibilità <i>Extensibility - Streckbarkeit - Extensibilité</i> | Prezzo (€) <i>Price - Preis - Prix</i> | E <i>cm</i> | Lato porta <i>Door - Tür - Porte</i> |
|---|--|---|---|-----------------------|---|
| LPST 10026W | 100 | 97 ÷ 100 | 471,00 | 40,5 | • |
| LPST 11026W | 110 | 107 ÷ 110 | 490,00 | 45,5 | • |
| LPST 12026W | 120 | 117 ÷ 120 | 512,00 | 50,5 | • |
| LPST 13026W | 130 | 127 ÷ 130 | 534,00 | 55,5 | • |
| LPST 14026W | 140 | 137 ÷ 140 | 558,00 | 60,5 | • |
| LPST 15026W | 150 | 147 ÷ 150 | 668,00 | 65,5 | • |
| LPST 16026W | 160 | 157 ÷ 160 | 768,00 | 70,5 | • |

6 mm
SCORREVOLI
SLIDING

PROFILO MAGGIORE ESTENSIBILITÀ

Wall profile adjustment - Verlängerungsprofil - Profilé pour extension supplémentaire

| Codice - Code Artikel - Article | Formato (cm) - Size Format - Dimension | + cm. | Prezzo (€) - Price Preis - Prix |
|------------------------------------|---|-------|------------------------------------|
| MTP 28W | 4,2 x 200 | 1,5 | 55,00 |

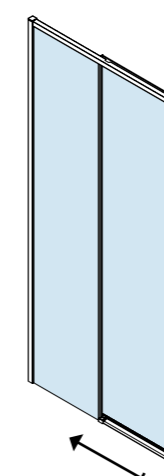

PROFILO A MURO LATO PORTA
WALL PROFILE FOR DOOR
WANDPROFIL FÜR TÜRSEITE
PROFIL DE MUR COTE PORTE

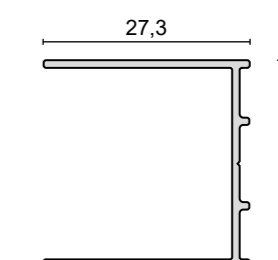

TRATTAMENTO ANTICALCARE

Descaling
Entkalkungsbehandlung
Traitement anticalcaire



TORCELLO WHITE

PROFILO BIANCO SATINATO - CRISTALLO TRASPARENTE

WHITE SATIN PROFILE - TRANSPARENT CRYSTAL
WEISS-SATINIERTES PROFIL - TRANSPARENTES KRISTALLGLAS
PROFILÉ BLANC SATINÉ - VERRE TRANSPARENT

| CODICE <i>Code - Artikel - Article</i> | Formato (cm) <i>Size - Format - Dimension</i> | Estensibilità <i>Extensibility - Streckbarkeit - Extensibilité</i> | Prezzo (€) <i>Price - Preis - Prix</i> | E <i>cm</i> | Lato porta <i>Door - Tür - Porte</i> |
|---|--|---|---|-----------------------|---|
| LPST 10026W | 100 | 97 ÷ 100 | 471,00 | 40,5 | • |
| LPST 11026W | 110 | 107 ÷ 110 | 490,00 | 45,5 | • |
| LPST 12026W | 120 | 117 ÷ 120 | 512,00 | 50,5 | • |
| LPST 13026W | 130 | 127 ÷ 130 | 534,00 | 55,5 | • |
| LPST 14026W | 140 | 137 ÷ 140 | 558,00 | 60,5 | • |
| LPST 15026W | 150 | 147 ÷ 150 | 668,00 | 65,5 | • |
| LPST 16026W | 160 | 157 ÷ 160 | 768,00 | 70,5 | • |

Parete fissa - Pezzi da ordinare
Side - Necessary pieces
Seite - Notwendige Stücke
Paroi fixe - Paroi à commander

| | | | | |
|-------------|----|-----------|--------|---|
| LPMTF 7016W | 70 | 67,5 ÷ 69 | 270,00 | 1 |
| LPMTF 7516W | 75 | 72,5 ÷ 74 | 292,00 | 1 |
| LPMTF 8016W | 80 | 77,5 ÷ 79 | 293,00 | 1 |
| LPMTF 9016W | 90 | 87,5 ÷ 89 | 316,00 | 1 |

PROFILO MAGGIORE ESTENSIBILITÀ PER LATO PORTA

Wall profile adjustment - Verlängerungsprofil - Profilé pour extension supplémentaire

| Codice - Code Artikel - Article | Formato (cm) - Size Format - Dimension | + cm. | Prezzo (€) - Price Preis - Prix |
|------------------------------------|---|-------|------------------------------------|
| MTP 28W | 4,2 x 200 | 1,5 | 55,00 |

PROFILO MAGGIORE ESTENSIBILITÀ PER LATO FISSO

Wall profile adjustment for side - Verlängerungsprofil für Seitenwand
Profilé pour extension supplémentaire de la paroi fixe

| Codice - Code Artikel - Article | Formato (cm) - Size Format - Dimension | + cm. | Prezzo (€) - Price Preis - Prix |
|------------------------------------|---|-------|------------------------------------|
| MTP 29W | 4,6 x 200 | 1,5 | 55,00 |

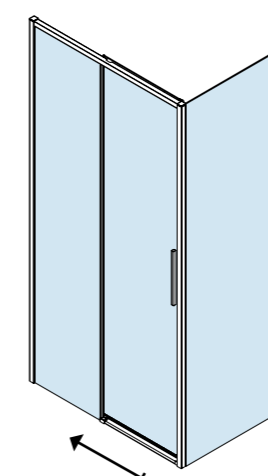

PROFILO A MURO LATO PORTA
WALL PROFILE FOR DOOR
WANDPROFIL FÜR TÜRSEITE
PROFIL DE MUR COTE PORTE

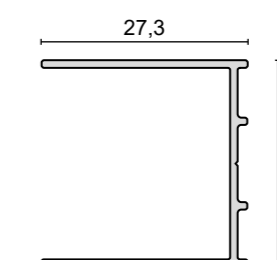

PROFILO A MURO LATO FISSO
WALL PROFILE SIDE PANEL
WANDPROFIL FÜR SEITENWAND
PROFIL DE MUR LATÉRAL FIXE

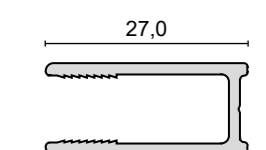

TRATTAMENTO ANTICALCARE

Descaling
Entkalkungsbehandlung
Traitement anticalcaire

TORCELLO WHITE

PROFILO BIANCO SATINATO - CRISTALLO TRASPARENTE

WHITE SATIN PROFILE - TRANSPARENT CRYSTAL
WEISS-SATINIERTES PROFIL - TRANSPARENTES KRISTALLGLAS
PROFILÉ BLANC SATINÉ - VERRRE TRANSPARENT

| CODICE <i>Code - Artikel - Article</i> | Formato (cm) <i>Size - Format - Dimension</i> | Estensibilità <i>Extensibility - Streckbarkeit - Extensibilité</i> | Prezzo (€) <i>Price - Preis - Prix</i> | E <i>cm</i> | Lato porta <i>Door - Tür - Porte</i> |
|---|--|---|---|----------------|---|
| LPST 10026W | 100 | 97 ÷ 100 | 471,00 | 40,5 | • |
| LPST 11026W | 110 | 107 ÷ 110 | 490,00 | 45,5 | • |
| LPST 12026W | 120 | 117 ÷ 120 | 512,00 | 50,5 | • |
| LPST 13026W | 130 | 127 ÷ 130 | 534,00 | 55,5 | • |
| LPST 14026W | 140 | 137 ÷ 140 | 558,00 | 60,5 | • |
| LPST 15026W | 150 | 147 ÷ 150 | 668,00 | 65,5 | • |
| LPST 16026W | 160 | 157 ÷ 160 | 768,00 | 70,5 | • |

Parete fissa - Pezzi da ordinare
Side - Necessary pieces
Seite - Notwendige Stücke
Paroi fixe - Paroi à commander

| | | | | |
|-------------|----|-----------|--------|---|
| LPMTF 7016W | 70 | 67,5 ÷ 69 | 270,00 | 2 |
| LPMTF 7516W | 75 | 72,5 ÷ 74 | 292,00 | 2 |
| LPMTF 8016W | 80 | 77,5 ÷ 79 | 293,00 | 2 |
| LPMTF 9016W | 90 | 87,5 ÷ 89 | 316,00 | 2 |

PROFILO MAGGIORE ESTENSIBILITÀ PER LATO FISSO

Wall profile adjustment for side - Verlängerungsprofil für Seitenwand
Profilé pour extension supplémentaire de la paroi fixe

| Codice - Code Artikel - Article | Formato (cm) - Size Format - Dimension | + cm. | Prezzo (€) - Price Preis - Prix |
|------------------------------------|---|-------|------------------------------------|
| MTP 29W | 4,6 x 200 | 1,5 | 55,00 |

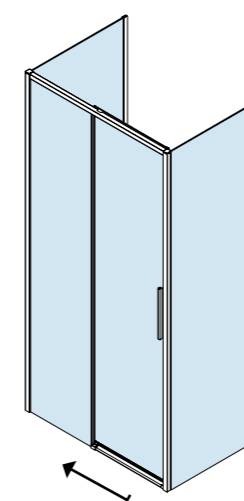

PROFILO A MURO LATO FISSO
WALL PROFILE SIDE PANEL
WANDPROFIL FÜR SEITENWAND
PROFIL DE MUR LATÉRAL FIXE

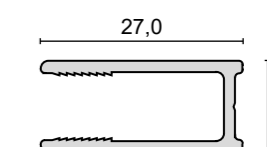

TORCELLO

LACUS RIVESTE... SU MISURA - LACUS MAKES IT... TO MEASURE - LACUS FERTIG ...MASSGERECHT - LACUS UNE FABRICATION SUR ...MESURE

Articoli speciali su ordinazione - Special Items on request - Sonderanfertigungen auf Bestellung - Articles 'à la carte' sur commande

| LATO FISSO - FIXED PANEL FESTE SEITENWAND - PANNEAU FIXE | LATO PORTA DOOR - TÜR - PORTE | VETRO SOPRA MURETTO - GLASS ON THE WALL GLAS AN DER WAND - PAROI SUR MURET |
|---|---|---|
| Altezza max 200 cm. - Larghezza max 150 cm. Height max 200 cm. - Width max 150 cm. Maximale Höhe 200 cm. - Maximale Breite 150 cm. Hauteur 200 cm. maximum - Largeur 150 cm. maximum | Altezza max 200 cm. - Larghezza max 170 cm. Height max 200 cm. - Width max 170 cm. Maximale Höhe 200 cm. - Maximale Breite 170 cm. Hauteur 200 cm. maximum - Largeur 170 cm. maximum | |



| PREZZO DI LISTINO AL PEZZO (TRASPARENTE) GROSS PREIS PRO PIECE (TRANSPARENT) LISTENPREIS PRO STÜCK (TRANSPARENT) PRIX TARIF PAR PIÈCE (TRANSPARENT) | PREVENTIVO SU RICHIESTA PRICE ON REQUEST ANGEBOT AUF ANFRAGE DEVIS SUR DEMANDE | PREVENTIVO SU RICHIESTA PRICE ON REQUEST ANGEBOT AUF ANFRAGE DEVIS SUR DEMANDE |
|--|---|---|
|--|---|---|

| | | | |
|--|---|--|--|
| | FASCIA 1: da 0,01 a 0,50 mq Level 1: from 0.01 to 0.5 sqm € 396,00 | | |
| | FASCIA 2: da 0,51 a 1,00 mq Level 2: from 0.51 to 1.0 sqm € 476,00 | | |
| | FASCIA 3: da 1,01 a 1,50 mq Level 3: from 1.01 to 1.5 sqm € 572,00 | | |
| | FASCIA 4: da 1,51 a 2,00 mq Level 4: from 1.51 to 2.0 sqm € 655,00 | | |
| | FASCIA 5: da 2,01 a 2,50 mq Level 5: from 2.01 to 2.5 sqm € 738,00 | | |
| | FASCIA 6: da 2,51 a 3,00 mq Level 6: from 2.51 to 3.0 sqm € 846,00 | | |

Maggiorazione per vetro Matt, Fox e Grey: +15%
Surcharge for matt, fox and grey crystal + 15%
Aufpreis für Matt, Fox und Grey Kristallglas +15%
Majoration pour les verres Matt, Fox et Grey: +15%

ATTENZIONE:
CALCOLARE I MQ. DEL PEZZO PER STABILIRE LA FASCIA DI APPARTENENZA
Per soluzioni diverse da quelle contemplate contattare ns. ufficio tecnico per avere indicazioni di fattibilità e prezzi.
VORSICHT:
BERECHNEN DIE QM. DES STÜCKES, ZUR ERFÜLLUNG DER ZUGEHÖRIGEN BAND
Für andere als die in Betracht gezogenen Lösungen wenden Sie sich an unser technisches Büro, um Informationen zu Machbarkeit und Preisen zu erhalten.

ATTENTION:
CALCULATE THE SQM OF THE ARTIKEL TO ESTABLISH THE BELONGING LEVEL.
For information on feasibility and prices of other solutions, please get in touch with our technical dept.
ATTENTION:
CALCULER LES M². DE LA PAROI POUR ÉTABLIR LA TRANCHE D'APPARTENANCE
Pour d'autres solutions que celles envisagées, contactez notre bureau technique pour connaître la faisabilité et les tarifs.

DETTAGLI & CARATTERISTICHE



GUIDA INFERIORE CON SGANCIO RAPIDO
OPENING CLIPS - LÖSBARE TÜR - PORTE DÉCLIPSANTES



MANIGLIA
HANDLE - GRIFF - POIGNÉE

6 mm
SCORREVOLI
SLIDING

CARATTERISTICHE GENERALI GENERAL CHARACTERISTICS TECHNISCHE MERKMALE SPECIFICATIONS GENERALES

- Cristallo temperato da 6 mm.
- Finitura trasparente.
- Profilo in alluminio cromo lucido, laccato nero satinato, bianco satinato e oro rosa.
- Chiusura magnetica delle ante.
- Sistema di sgancio rapido.
- Estensione profilo a muro 1,5 cm.
- Maniglia in alluminio.
- Tempered crystal from 6 mm.
- Transparent.
- Chrome aluminum, black, white or rose gold profile.
- Magnetic waterproof clousure.
- Opening clip for easy cleaning.
- Wall profile adjustment 1,5 cm.
- Aluminium handle.
- Sekuritkristallglas 6 mm stark.
- Kristallglasfinish: Transparent.
- Poliertes Chrom- schwarz- weiß-rosè gold Profil.
- Magnetverschluss.
- Lösbare Tür zur Kristallreinigung.
- Streckbarket 1,5 cm.
- Griff aus aluminium.
- Verre trempé de 6 mm.
- Finition du verre: transparent.
- Profilé en aluminium chromé, noir satiné et blanc satiné et or rosé.
- Portes à fermeture magnétique.
- Portes déclipantes dans la partie basse pour le nettoyage du verre.
- Extensibilité 1,5 cm.
- Poignée en aluminium.



TRATTAMENTO ANTICALCARE

Descaling
Entkalkungsbehandlung
Traitement anticalcaire

ASINARA

CRISTALLO TRASPARENTE
TRANSPARENT CRYSTAL
TRANSPARENTES KRISTALLGLAS
VERRE TRANSPARENT

| CODICE <small>Code - Artikel - Article</small> | Formato (cm) <small>Size - Format - Dimension</small> | Estensibilità <small>Extensibility - Streckbarkeit - Extensibilité</small> | Prezzo (€) <small>Price - Preis - Prix</small> | E <small>cm</small> | Singolo lato <small>Single side Einzel Seite - Seul côté</small> |
|---|--|---|---|-------------------------------|---|
| LSA6 70 | 70 | 67 ÷ 69 | 581,00 | 17,0 | • |
| LSA6 80 | 80 | 77 ÷ 79 | 608,00 | 20,5 | • |
| LSA6 90 | 90 | 87 ÷ 89 | 636,00 | 24,0 | • |
| LSA6 100 | 100 | 97 ÷ 99 | 662,00 | 27,5 | • |
| LSA6 110 | 110 | 107 ÷ 109 | 688,00 | 31,0 | • |
| LSA6 120 | 120 | 117 ÷ 119 | 722,00 | 34,5 | • |
| LSA6 130 | 130 | 127 ÷ 129 | 767,00 | 37,0 | • |
| LSA6 140 | 140 | 137 ÷ 139 | 795,00 | 40,5 | • |

*E: Spazio utile entrata - Entrance - Eingang - Entrée

↳ Sommare i valori dei singoli lati - Sum the value of each side -

Den Wert der einzelnen Seite addieren - Additionner la valeur de chaque côté

***Prezzo: ATTENZIONE il prezzo è relativo ad un singolo lato.**

*Price: NOTICE: Price is for 1 side only.

*Preis: VORSICHT: Der Preis ist für eine einzelne Seite.

*Prix: ATTENTION: le prix est pour un seul côté.

PROFILO MAGGIORE ESTENSIBILITÀ

Wall profile adjustment - Verlängerungsprofil - Profilé pour extension supplémentaire

| Codice - Code Artikel - Article | Formato (cm) - Size Format - Dimension | + cm. | Prezzo (€) - Price Preis - Prix |
|------------------------------------|---|-------|------------------------------------|
| MTP 25 | 5,5 x 200 | 2,0 | 95,00 |

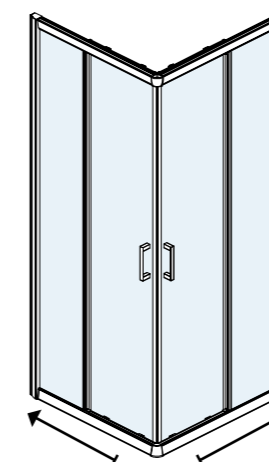

PROFILO A MURO WALL PROFILE - WANDPROFIL - PROFIL DE MUR

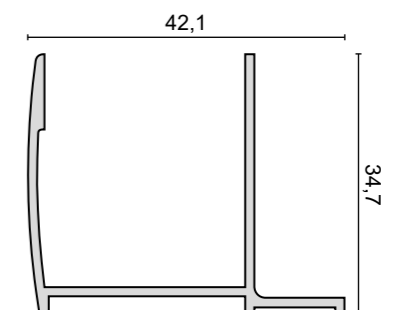

TRATTAMENTO ANTICALCARE

Descaling
Entkalkungsbehandlung
Traitement anticalcaire

PIANA

CRISTALLO TRASPARENTE
TRANSPARENT CRYSTAL
TRANSPARENTES KRISTALLGLAS
VERRE TRANSPARENT

| CODICE <i>Code - Artikel - Article</i> | Formato (cm) <i>Size - Format - Dimension</i> | Estensibilità <i>Extensibility - Streckbarkeit - Extensibilité</i> | Prezzo (€) <i>Price - Preis - Prix</i> | E <i>cm</i> | Lato porta <i>Door - Tür - Porte</i> |
|--|---|--|--|-----------------------|--|
| LSA6N 10026 | 100 | 97 ÷ 101 | 754,00 | 38,0 | • |
| LSA6N 11026 | 110 | 107 ÷ 111 | 780,00 | 43,0 | • |
| LSA6N 12026 | 120 | 117 ÷ 121 | 814,00 | 48,0 | • |
| LSA6N 13026 | 130 | 127 ÷ 131 | 858,00 | 53,0 | • |
| LSA6N 14026 | 140 | 137 ÷ 141 | 886,00 | 58,0 | • |
| LSA6N 15026 | 150 | 147 ÷ 151 | 913,00 | 63,0 | • |
| LSA6N 16026 | 160 | 157 ÷ 161 | 929,00 | 68,0 | • |

6 mm
SCORREVOLI
SLIDING

PROFILO MAGGIORE ESTENSIBILITÀ

Wall profile adjustment - Verlängerungsprofil - Profilé pour extension supplémentaire

| Codice - Code <i>Artikel - Article</i> | Formato (cm) - Size <i>Format - Dimension</i> | + cm. | Prezzo (€) - Price <i>Preis - Prix</i> |
|--|---|--------------|--|
| MTP 25 | 5,5 x 200 | 2,0 | 95,00 |

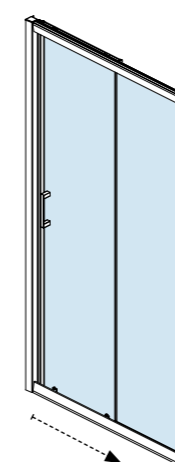

PROFILO A MURO WALL PROFILE - WANDPROFIL - PROFIL DE MUR

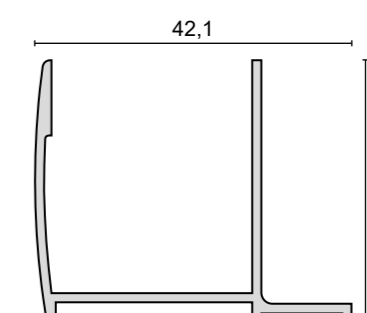

TRATTAMENTO ANTICALCARE

Descaling
Entkalkungsbehandlung
Traitement anticalcaire

PIANA

CRISTALLO TRASPARENTE

TRANSPARENT CRYSTAL
TRANSPARENTES KRISTALLGLAS
VERRE TRANSPARENT

| CODICE <i>Code - Artikel - Article</i> | Formato (cm) <i>Size - Format - Dimension</i> | Estensibilità <i>Extensibility - Streckbarkeit - Extensibilité</i> | Prezzo (€) <i>Price - Preis - Prix</i> | E <i>cm</i> | Lato porta <i>Door - Tür - Porte</i> |
|--|---|--|--|-----------------------|--|
| LSA6N 10026 | 100 | 97 ÷ 101 | 754,00 | 38,0 | • |
| LSA6N 11026 | 110 | 107 ÷ 111 | 780,00 | 43,0 | • |
| LSA6N 12026 | 120 | 117 ÷ 121 | 814,00 | 48,0 | • |
| LSA6N 13026 | 130 | 127 ÷ 131 | 858,00 | 53,0 | • |
| LSA6N 14026 | 140 | 137 ÷ 141 | 886,00 | 58,0 | • |
| LSA6N 15026 | 150 | 147 ÷ 151 | 913,00 | 63,0 | • |
| LSA6N 16026 | 160 | 157 ÷ 161 | 929,00 | 68,0 | • |

Parete fissa - Pezzi da ordinare
Side - Necessary pieces
Seite - Notwendige Stücke
Paroi fixe - Paroi à commander

| | | | | |
|-------------------------|----|---------|--------|----------|
| LPF EVO2 6516 QI | 65 | 62 ÷ 64 | 314,00 | 1 |
| LPF EVO2 7016 QI | 70 | 67 ÷ 69 | 336,00 | 1 |
| LPF EVO2 7516 QI | 75 | 72 ÷ 74 | 353,00 | 1 |
| LPF EVO2 8016 QI | 80 | 77 ÷ 79 | 370,00 | 1 |
| LPF EVO2 9016 QI | 90 | 87 ÷ 89 | 392,00 | 1 |

PROFILO MAGGIORE ESTENSIBILITÀ

Wall profile adjustment - Verlängerungsprofil - Profilé pour extension supplémentaire

| Codice - Code <i>Artikel - Article</i> | Formato (cm) - Size <i>Format - Dimension</i> | + cm. | Prezzo (€) - Price <i>Preis - Prix</i> |
|--|---|--------------|--|
| MTP 25 | 5,5 x 200 | 2,0 | 95,00 |

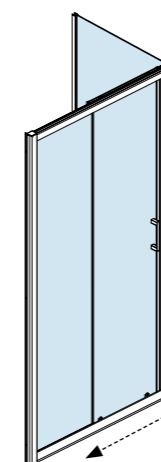

PROFILO A MURO WALL PROFILE - WANDPROFIL - PROFIL DE MUR

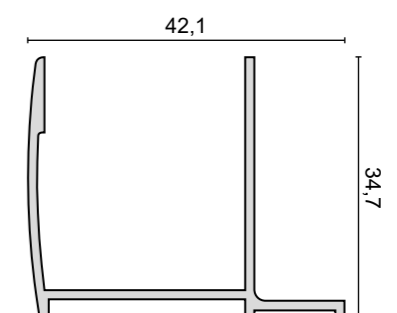

TRATTAMENTO ANTICALCARE

Descaling
Entkalkungsbehandlung
Traitement anticalcaire

PIANA

CRISTALLO TRASPARENTE
TRANSPARENT CRYSTAL
TRANSPARENTES KRISTALLGLAS
VERRE TRANSPARENT

| CODICE <i>Code - Artikel - Article</i> | Formato (cm) <i>Size - Format - Dimension</i> | Estensibilità <i>Extensibility - Streckbarkeit - Extensibilité</i> | Prezzo (€) <i>Price - Preis - Prix</i> | E <i>cm</i> | Lato porta <i>Door - Tür - Porte</i> |
|--|---|--|--|-----------------------|--|
| LSA6N 10026 | 100 | 97 ÷ 101 | 754,00 | 38,0 | • |
| LSA6N 11026 | 110 | 107 ÷ 111 | 780,00 | 43,0 | • |
| LSA6N 12026 | 120 | 117 ÷ 121 | 814,00 | 48,0 | • |
| LSA6N 13026 | 130 | 127 ÷ 131 | 858,00 | 53,0 | • |
| LSA6N 14026 | 140 | 137 ÷ 141 | 886,00 | 58,0 | • |
| LSA6N 15026 | 150 | 147 ÷ 151 | 913,00 | 63,0 | • |
| LSA6N 16026 | 160 | 157 ÷ 161 | 929,00 | 68,0 | • |

Parete fissa - Pezzi da ordinare
Side - Necessary pieces
Seite - Notwendige Stücke
Paroi fixe - Paroi à commander

| | | | | |
|-------------------------|----|---------|--------|----------|
| LPF EVO2 6516 QI | 65 | 62 ÷ 64 | 314,00 | 2 |
| LPF EVO2 7016 QI | 70 | 67 ÷ 69 | 336,00 | 2 |
| LPF EVO2 7516 QI | 75 | 72 ÷ 74 | 353,00 | 2 |
| LPF EVO2 8016 QI | 80 | 77 ÷ 79 | 370,00 | 2 |
| LPF EVO2 9016 QI | 90 | 87 ÷ 89 | 392,00 | 2 |

PROFILO MAGGIORE ESTENSIBILITÀ

Wall profile adjustment - Verlängerungsprofil - Profilé pour extension supplémentaire

| Codice - Code <i>Artikel - Article</i> | Formato (cm) - Size <i>Format - Dimension</i> | + cm. | Prezzo (€) - Price <i>Preis - Prix</i> |
|--|---|--------------|--|
| MTP 25 | 5,5 x 200 | 2,0 | 95,00 |

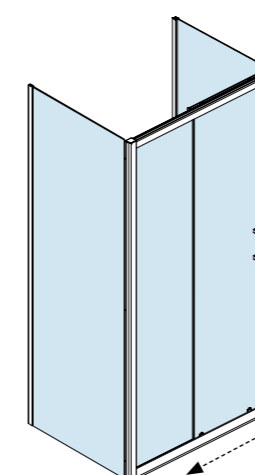

PROFILO A MURO

WALL PROFILE - WANDPROFIL - PROFIL DE MUR

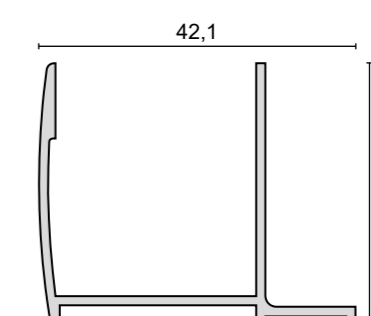

ASINARA / PIANA

LACUS RIVESTE... SU MISURA - LACUS MAKES IT... TO MEASURE - LACUS FERTIG ...MASSGERECHT - LACUS UNE FABRICATION SUR ...MESURE
 Articoli speciali su ordinazione - Special Items on request - Sonderanfertigungen auf Bestellung - Articles 'à la carte' sur commande

| | LATO FISSO - FIXED PANEL FESTE SEITENWAND - PANNEAU FIXE | LATO PORTA DOOR - TÜR - PORTE | VETRO SOPRA MURETTO - GLASS ON THE WALL GLAS AN DER WAND - PAROI SUR MURET |
|---------|---|---|---|
| | Altezza max 200 cm. - Larghezza max 125 cm. Height max 200 cm. - Width max 125 cm. Maximale Höhe 200 cm. - Maximale Breite 125 cm. Hauteur 200 cm. maximum - Largeur 125 cm. maximum | Altezza max 200 cm. - Larghezza max 200 cm. Height max 200 cm. - Width max 200 cm. Maximale Höhe 200 cm. - Maximale Breite 200 cm. Hauteur 200 cm. maximum - Largeur 200 cm. maximum | NON DISPONIBILE UNAVAILABLE NICHT VERFÜGBAR PAS DISPONIBLE |
| ASINARA | | | |
| PIANA | | | |

| PREZZO DI LISTINO AL PEZZO (TRASPARENTE) GROSS PREIS PRO PIECE (TRANSPARENT) LISTENPREIS PRO STÜCK (TRANSPARENT) PRIX TARIF PAR PIÈCE (TRANSPARENT) | PREVENTIVO SU RICHIESTA PRICE ON REQUEST ANGEBOT AUF ANFRAGE DEVIS SUR DEMANDE | PREVENTIVO SU RICHIESTA PRICE ON REQUEST ANGEBOT AUF ANFRAGE DEVIS SUR DEMANDE |
|--|---|---|
|--|---|---|

| | | | | | | |
|--|---|----------|--|---------|--|--|
| | FASCIA 1: da 0,01 a 0,50 mq Level 1: from 0.01 to 0.5 sqm | € 450,00 | | ASINARA | NON DISPONIBILE UNAVAILABLE NICHT VERFÜGBAR PAS DISPONIBLE | |
| | FASCIA 2: da 0,51 a 1,00 mq Level 2: from 0.51 to 1.0 sqm | € 546,00 | | | | |
| | FASCIA 3: da 1,01 a 1,50 mq Level 3: from 1.01 to 1.5 sqm | € 643,00 | | | | |
| | FASCIA 4: da 1,51 a 2,00 mq Level 4: from 1.51 to 2.0 sqm | € 726,00 | | | PIANA | |
| | FASCIA 5: da 2,01 a 2,50 mq Level 5: from 2.01 to 2.5 sqm | € 808,00 | | | PIANA | |

| | | |
|---|--|--|
| ASINARA Maggiorazione per vetro Matt, Fox e Grey: +15% Surcharge for matt, fox and grey crystal + 15% Aufpreis für Matt, Fox und Grey Kristallglas +15% Majoration pour les verres Matt, Fox et Grey: +15% | | |
| PIANA Maggiorazione per vetro Matt e Grey: +15% Surcharge for matt and grey crystal + 15% Aufpreis für Matt und Grey Kristallglas +15% Majoration pour les verres Matt e Grey: +15% | | |

| | |
|---|--|
| ATTENZIONE: CALCOLARE I MQ. DEL PEZZO PER STABILIRE LA FASCIA DI APPARTENENZA Per soluzioni diverse da quelle contemplate contattare ns. ufficio tecnico per avere indicazioni di fattibilità e prezzi. | ATTENTION: CALCULATE THE SQM OF THE ARTIKEL TO ESTABLISH THE BELONGING LEVEL. For information on feasibility and prices of other solutions, please get in touch with our technical dept. |
| VORSICHT: BERECHNEN DIE QM. DES STÜCKES, ZUR ERFÜLLUNG DER ZUGEHÖRIGEN BAND Für andere als die in Betracht gezogenen Lösungen wenden Sie sich an unser technisches Büro, um Informationen zu Machbarkeit und Preisen zu erhalten. | ATTENTION: CALCULER LES M². DE LA PAROI POUR ÉTABLIR LA TRANCHLE D'APPARTENANCE Pour d'autres solutions que celles envisagées, contactez notre bureau technique pour connaître la faisabilité et les tarifs. |

DETTAGLI & CARATTERISTICHE



ASINARA / PIANA
PROFILO INFERIORE
BOTTOM PROFILE - UNTERES PROFIL - PROFILÉ INFÉRIEUR



MANIGLIA ASINARA/PIANA
HANDLE - GRIFF - POIGNÉE

CARATTERISTICHE GENERALI

- Cristallo temperato da 6mm.
- Finitura trasparente.
- Profilo in alluminio cromo lucido.
- Chiusura magnetica delle ante.
- Estensione 2 cm.
- Soft Closing.
- Maniglie in ottone cromato.

GENERAL CHARACTERISTICS

- Tempered crystal 6 mm.
- Transparent.
- Chrome aluminum profile.
- Magnetic waterproof clousure.
- Wall profile adjustment 2 cm.
- Soft closing.
- Handles in chromed brass.

TECHNISCHE MERKMALE

- Sekurirkristallglas 6 mm stark.
- Kristallglasfinish: Transparen.
- Poliertes Chrom Profil.
- Magnetverschluss.
- Streckbarkeit 2 cm.
- Selbstschliessende Schiebetür.
- Griff aus verchromtem Messing.

SPECIFICATIONS GENERALES

- Verre trempé de 6 mm.
- Finition du verre: transparent.
- Profilé en aluminium chromé.
- Portes à fermeture magnétique.
- Fermeture de la porte coulissante en douceur.
- Extensibilité de 2 cm.
- Poignées en laiton chromé.

6 mm
SCORREVOLI
SLIDING

EOLIE

CRISTALLO TRASPARENTE
TRANSPARENT CRYSTAL
TRANSPARENTES KRISTALLGLAS
VERRE TRANSPARENT

| CODICE <i>Code - Artikel - Article</i> | Formato (cm) <i>Size - Format - Dimension</i> | Estensibilità <i>Extensibility - Streckbarkeit - Extensibilité</i> | Prezzo unitario <i>Price - Preis - Prix</i> | E <i>cm</i> | Lato porta <i>Door - Tür - Porte</i> |
|--|---|--|---|-----------------------|--|
| LPS EVO2 9036 QI | 90 | 86 ÷ 90 | 823,00 | 45,0 | • |
| LPS EVO2 10036 QI | 100 | 96 ÷ 100 | 856,00 | 51,5 | • |
| LPS EVO2 10536 QI | 105 | 101 ÷ 105 | 874,00 | 54,7 | • |
| LPS EVO2 11036 QI | 110 | 106 ÷ 110 | 892,00 | 58,0 | • |
| LPS EVO2 11536 QI | 115 | 111 ÷ 115 | 909,00 | 61,5 | • |
| LPS EVO2 12036 QI | 120 | 116 ÷ 120 | 926,00 | 64,8 | • |
| LPS EVO2 12536 QI | 125 | 121 ÷ 125 | 935,00 | 68,2 | • |
| LPS EVO2 13036 QI | 130 | 126 ÷ 130 | 960,00 | 71,5 | • |
| LPS EVO2 13536 QI | 135 | 131 ÷ 135 | 978,00 | 74,7 | • |
| LPS EVO2 14036 QI | 140 | 136 ÷ 140 | 996,00 | 78,0 | • |

6 mm
SCORREVOLI
SLIDING

PROFILO MAGGIORE ESTENSIBILITÀ

Wall profile adjustment - Verlängerungsprofil - Profilé pour extension supplémentaire

| Codice - Code <i>Artikel - Article</i> | Formato (cm) - Size <i>Format - Dimension</i> | + cm. | Prezzo (€) - Price <i>Preis - Prix</i> |
|--|---|--------------|--|
| MTP 25 | 5,5 x 200 | 2,0 | 95,00 |

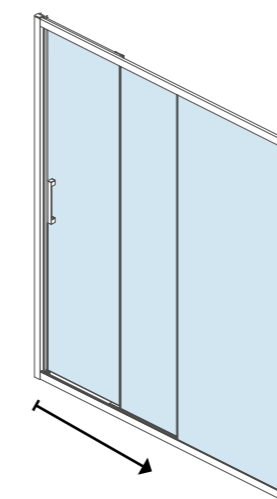

PROFILO A MURO WALL PROFILE - WANDPROFIL - PROFIL DE MUR

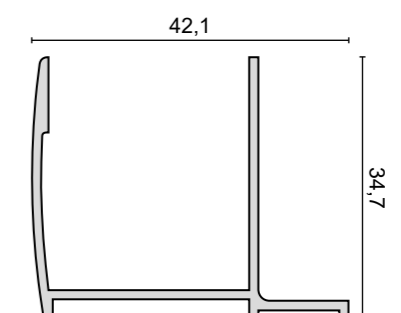

TRATTAMENTO ANTICALCARE

Descaling
Entkalkungsbehandlung
Traitement anticalcaire

TRATTAMENTO ANTICALCARE

Descaling
Entkalkungsbehandlung
Traitement anticalcaire

EOLIE

CRISTALLO TRASPARENTE
TRANSPARENT CRYSTAL
TRANSPARENTES KRISTALLGLAS
VERRE TRANSPARENT

| CODICE <i>Code - Artikel - Article</i> | Formato (cm) <i>Size - Format - Dimension</i> | Estensibilità <i>Extensibility - Streckbarkeit - Extensibilité</i> | Prezzo unitario <i>Price - Preis - Prix</i> | E <i>cm</i> | Lato porta <i>Door - Tür - Porte</i> |
|--|---|--|---|-----------------------|--|
| LPS EVO2 9036 QI | 90 | 86 ÷ 90 | 823,00 | 45,0 | • |
| LPS EVO2 10036 QI | 100 | 96 ÷ 100 | 856,00 | 51,5 | • |
| LPS EVO2 10536 QI | 105 | 101 ÷ 105 | 874,00 | 54,7 | • |
| LPS EVO2 11036 QI | 110 | 106 ÷ 110 | 892,00 | 58,0 | • |
| LPS EVO2 11536 QI | 115 | 111 ÷ 115 | 909,00 | 61,5 | • |
| LPS EVO2 12036 QI | 120 | 116 ÷ 120 | 926,00 | 64,8 | • |
| LPS EVO2 12536 QI | 125 | 121 ÷ 125 | 935,00 | 68,2 | • |
| LPS EVO2 13036 QI | 130 | 126 ÷ 130 | 960,00 | 71,5 | • |
| LPS EVO2 13536 QI | 135 | 131 ÷ 135 | 978,00 | 74,7 | • |
| LPS EVO2 14036 QI | 140 | 136 ÷ 140 | 996,00 | 78,0 | • |

Parete fissa - Pezzi da ordinare
Side - Necessary pieces
Seite - Notwendige Stücke
Paroi fixe - Paroi à commander

| | | | | |
|------------------|----|---------|--------|----------|
| LPF EVO2 6516 QI | 65 | 62 ÷ 64 | 314,00 | 1 |
| LPF EVO2 7016 QI | 70 | 67 ÷ 69 | 336,00 | 1 |
| LPF EVO2 7516 QI | 75 | 72 ÷ 74 | 353,00 | 1 |
| LPF EVO2 8016 QI | 80 | 77 ÷ 79 | 370,00 | 1 |
| LPF EVO2 9016 QI | 90 | 87 ÷ 89 | 393,00 | 1 |

PROFILO MAGGIORE ESTENSIBILITÀ

Wall profile adjustment - Verlängerungsprofil - Profilé pour extension supplémentaire

| Codice - Code <i>Artikel - Article</i> | Formato (cm) - Size <i>Format - Dimension</i> | + cm. | Prezzo (€) - Price <i>Preis - Prix</i> |
|--|---|--------------|--|
| MTP 25 | 5,5 x 200 | 2,0 | 95,00 |

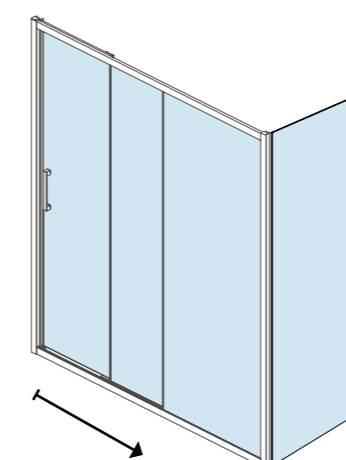

PROFILO A MURO
WALL PROFILE - WANDPROFIL - PROFIL DE MUR

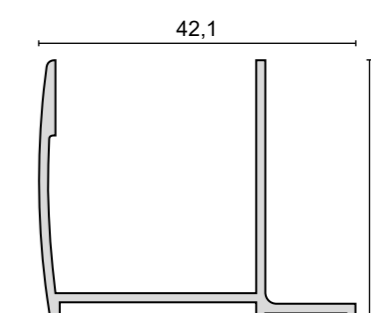

6 mm
SCORREVOLI
SLIDING



EOLIE

CRISTALLO TRASPARENTE
 TRANSPARENT CRYSTAL
 TRANSPARENTES KRISTALLGLAS
 VERRE TRANSPARENT

| CODICE <i>Code - Artikel - Article</i> | Formato (cm) <i>Size - Format - Dimension</i> | Estensibilità <i>Extensibility - Streckbarkeit - Extensibilité</i> | Prezzo unitario <i>Price - Preis - Prix</i> | E <i>cm</i> | Lato porta <i>Door - Tür - Porte</i> |
|--|---|--|---|-----------------------|--|
| LPS EVO2 9036 QI | 90 | 86 ÷ 90 | 823,00 | 45,0 | • |
| LPS EVO2 10036 QI | 100 | 96 ÷ 100 | 856,00 | 51,5 | • |
| LPS EVO2 10536 QI | 105 | 101 ÷ 105 | 874,00 | 54,7 | • |
| LPS EVO2 11036 QI | 110 | 106 ÷ 110 | 892,00 | 58,0 | • |
| LPS EVO2 11536 QI | 115 | 111 ÷ 115 | 909,00 | 61,5 | • |
| LPS EVO2 12036 QI | 120 | 116 ÷ 120 | 926,00 | 64,8 | • |
| LPS EVO2 12536 QI | 125 | 121 ÷ 125 | 935,00 | 68,2 | • |
| LPS EVO2 13036 QI | 130 | 126 ÷ 130 | 960,00 | 71,5 | • |
| LPS EVO2 13536 QI | 135 | 131 ÷ 135 | 978,00 | 74,7 | • |
| LPS EVO2 14036 QI | 140 | 136 ÷ 140 | 996,00 | 78,0 | • |

Parete fissa - Pezzi da ordinare
Side - Necessary pieces
Seite - Notwendige Stücke
Paroi fixe - Paroi à commander

| | | | | |
|------------------|----|---------|--------|---|
| LPF EVO2 6516 QI | 65 | 62 ÷ 64 | 314,00 | 2 |
| LPF EVO2 7016 QI | 70 | 67 ÷ 69 | 336,00 | 2 |
| LPF EVO2 7516 QI | 75 | 72 ÷ 74 | 353,00 | 2 |
| LPF EVO2 8016 QI | 80 | 77 ÷ 79 | 370,00 | 2 |
| LPF EVO2 9016 QI | 90 | 87 ÷ 89 | 393,00 | 2 |

PROFILO MAGGIORE ESTENSIBILITÀ

Wall profile adjustment - Verlängerungsprofil - Profilé pour extension supplémentaire

| Codice - Code <i>Artikel - Article</i> | Formato (cm) - Size <i>Format - Dimension</i> | + cm. | Prezzo (€) - Price <i>Preis - Prix</i> |
|--|---|--------------|--|
| MTP 25 | 5,5 x 200 | 2,0 | 95,00 |

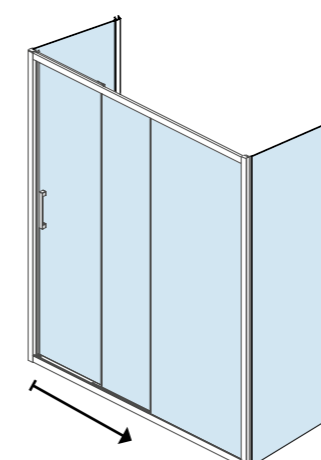

PROFILO A MURO

WALL PROFILE - WANDPROFIL - PROFIL DE MUR

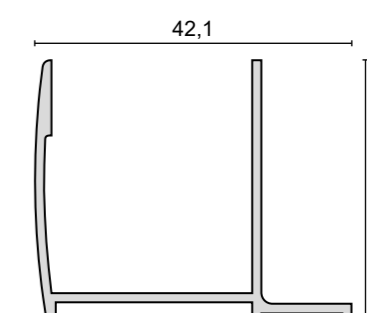

TRATTAMENTO ANTICALCARE
Descaling
Entkalkungsbehandlung
Traitement anticalcaire

LACUS RIVESTE... SU MISURA - LACUS MAKES IT... TO MEASURE - LACUS FERTIG ...MASSGERECHT - LACUS UNE FABRICATION SUR ...MESURE

Articoli speciali su ordinazione - Special Items on request - Sonderanfertigungen auf Bestellung - Articles 'à la carte' sur commande

| | | |
|---|--|--|
| <p>LATO FISSO - FIXED PANEL FESTE SEITENWAND - PANNEAU FIXE</p> | <p>LATO PORTA DOOR - TÜR - PORTE</p> | <p>VETRO SOPRA MURETTO - GLASS ON THE WALL GLAS AN DER WAND - PAROI SUR MURET</p> |
| <p>Altezza max 200 cm. - Larghezza max 125 cm. Height max 200 cm. - Width max 125 cm. Maximale Höhe 200 cm. - Maximale Breite 125 cm. Hauteur 200 cm. maximum - Largeur 125 cm. maximum</p> | <p>NON DISPONIBILE UNAVAILABLE NICHT VERFÜGBAR PAS DISPONIBLE</p> | |
| <p> </p> | | <p> </p> |

| | | |
|---|--|--|
| <p>PREZZO DI LISTINO AL PEZZO (TRASPARENTE) GROSS PREIS PRO PIECE (TRANSPARENT) LISTENPREIS PRO STÜCK (TRANSPARENT) PRIX TARIF PAR PIÉCE (TRANSPARENT)</p> | <p>NON DISPONIBILE UNAVAILABLE NICHT VERFÜGBAR PAS DISPONIBLE</p> | <p>PREVENTIVO SU RICHIESTA PRICE ON REQUEST ANGEBOT AUF ANFRAGE DEVIS SUR DEMANDE</p> |
|---|--|--|

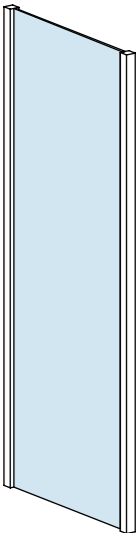
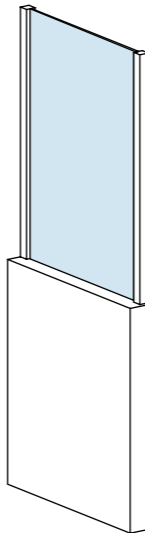
| | | | | |
|--|---|-----------------|--|--|
|  | <p>FASCIA 1: da 0,01 a 0,50 mq Level 1: from 0.01 to 0.5 sqm</p> | <p>€ 450,00</p> | <p>NON DISPONIBILE UNAVAILABLE NICHT VERFÜGBAR PAS DISPONIBLE</p> |  |
| | <p>FASCIA 2: da 0,51 a 1,00 mq Level 2: from 0.51 to 1.0 sqm</p> | <p>€ 546,00</p> | | |
| | <p>FASCIA 3: da 1,01 a 1,50 mq Level 3: from 1.01 to 1.5 sqm</p> | <p>€ 643,00</p> | | |
| | <p>FASCIA 4: da 1,51 a 2,00 mq Level 4: from 1.51 to 2.0 sqm</p> | <p>€ 726,00</p> | | |
| | <p>FASCIA 5: da 2,01 a 2,50 mq Level 5: from 2.01 to 2.5 sqm</p> | <p>€ 808,00</p> | | |

| | |
|--|---|
| <p>ATTENZIONE: CALCOLARE I MQ. DEL PEZZO PER STABILIRE LA FASCIA DI APPARTENENZA Per soluzioni diverse da quelle contemplate contattare ns. ufficio tecnico per avere indicazioni di fattibilità e prezzi. VORSICHT: BERECHNEN DIE QM. DES STÜCKES, ZUR ERFÜLLUNG DER ZUGEHÖRIGEN BAND Für andere als die in Betracht gezogenen Lösungen wenden Sie sich an unser technisches Büro, um Informationen zu Machbarkeit und Preisen zu erhalten.</p> | <p>ATTENTION: CALCULATE THE SQM OF THE ARTIKEL TO ESTABLISH THE BELONGING LEVEL. For information on feasibility and prices of other solutions, please get in touch with our technical dept. ATTENTION: CALCULER LES M². DE LA PAROI POUR ÉTABLIR LA TRANCHE D'APPARTENANCE Pour d'autres solutions que celles envisagées, contactez notre bureau technique pour connaître la faisabilité et les tarifs.</p> |
|--|---|



MANIGLIA EOLIE
HANDLE - GRIFF - POIGNÉE



PROFILO INFERIORE EOLIE
BOTTOM PROFILE
UNTERES PROFIL
PROFILÉ INFÉRIEUR

6 mm
SCORREVOLI
SLIDING

| | | | |
|--|---|--|---|
| <p>CARATTERISTICHE GENERALI</p> <ul style="list-style-type: none"> • Cristallo temperato da 6mm. • Finitura trasparente. • Profilo in alluminio cromo lucido. • Chiusura magnetica delle ante. • Estensione 2 cm. • Maniglie in ottone cromato. | <p>GENERAL CHARACTERISTICS</p> <ul style="list-style-type: none"> • Tempered crystal 6 mm. • Transparent. • Chrome aluminum profile. • Magnetic waterproof clousure. • Wall profile adjustment 2 cm. • Handles in chromed brass. | <p>TECHNISCHE MERKMALE</p> <ul style="list-style-type: none"> • Sekurirkristallglas 6 mm stark. • Kristallglasfinish: Transparent. • Poliertes Chrom Profil. • Magnetverschluss. • Streckbarkeit 2 cm. • Griff aus verchromtem Messing. | <p>SPECIFICATIONS GENERALES</p> <ul style="list-style-type: none"> • Verre trempé de 6 mm. • Finition du verre: transparent. • Profilé en aluminium chromé. • Portes à fermeture magnétique. • Extensibilité de 2 cm. • Poignées en laiton chromé. |
|--|---|--|---|



VULCANO EVO BT

PROFILO NERO SATINATO - CRISTALLO TRASPARENTE

BLACK SATIN PROFILE - TRANSPARENT CRYSTAL
SCHWARZ-SATINIERTES PROFIL - TRANSPARENTES KRISTALLGLAS
PROFILÉ NOIR SATINÉ - VERRE TRANSPARENT

| CODICE <i>Code - Artikel - Article</i> | Formato (cm) <i>Size - Format - Dimension</i> | Estensibilità <i>Extensibility - Streckbarkeit - Extensibilité</i> | *Prezzo (€) <i>Price - Preis - Prix</i> | E <i>cm</i> | Singolo lato <i>Single side Einzel Seite - Seul côté</i> |
|---|--|---|--|-----------------------|---|
| LASP3 70BT QI | 70 | 67,5 ÷ 69 | 530,00 | 17,5 | • |
| LASP3 75BT QI | 75 | 72,5 ÷ 74 | 546,00 | 19,3 | • |
| LASP3 80BT QI | 80 | 77,5 ÷ 79 | 569,00 | 21,0 | • |
| LASP3 90BT QI | 90 | 87,5 ÷ 89 | 604,00 | 24,5 | • |
| LASP3 100BT QI | 100 | 97,5 ÷ 99 | 639,00 | 28,0 | • |
| LASP3 110BT QI | 110 | 107,5 ÷ 109 | 674,00 | 31,5 | • |
| LASP3 120BT QI | 120 | 117,5 ÷ 119 | 695,00 | 35,0 | • |
| LASP3 130BT QI | 130 | 127,5 ÷ 129 | 733,00 | 35,0 | • |
| LASP3 140BT QI | 140 | 137,5 ÷ 139 | 776,00 | 35,0 | • |

*E: Spazio utile entrata - Entrance - Eingang - Entrée

↳ Sommare i valori dei singoli lati - Sum the value of each side -

Den Wert der einzelnen Seite addieren - Additionner la valeur de chaque côté

*Prezzo: ATTENZIONE il prezzo è relativo ad un singolo lato.

*Price: NOTICE: Price is for 1 side only.

*Preis: VORSICHT: Der Preis ist für eine einzelne Seite.

*Prix: ATTENTION: le prix est pour un seul côté.

PROFILO MAGGIORE ESTENSIBILITÀ

Wall profile adjustment - Verlängerungsprofil - Profilé pour extension supplémentaire

| Codice - Code Artikel - Article | Formato (cm) - Size Format - Dimension | + cm. | Prezzo (€) - Price Preis - Prix |
|------------------------------------|---|-------|------------------------------------|
| MTP 31B QI | 4,2 x 200 | 1,5 | 88,00 |

Possibilità di formare 3° lato con modello LPF3 BT (pag. 339).

The 3rd side can be made with the LPF3 BT model (page 339).

Möglichkeit die 3. Seitenwand mit LPF3 BT-Modell (S. 339) einzubauen.

Possibilité de réaliser le 3e côté avec le modèle LPF3 BT (page 339).

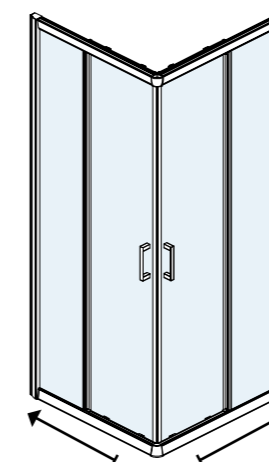

PROFILO A MURO
WALL PROFILE - WANDPROFIL - PROFIL DE MUR

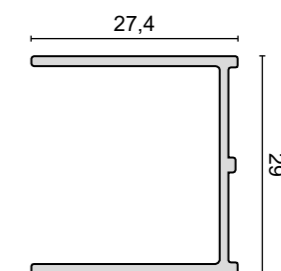

TRATTAMENTO
ANTICALCARE

Descaling
Entkalkungsbehandlung
Traitement anticalcaire

TRATTAMENTO ANTICALCARE

Descaling
Entkalkungsbehandlung
Traitement anticalcaire



VULCANO EVO

CRISTALLO TRASPARENTE
TRANSPARENT CRYSTAL
TRANSPARENTES KRISTALLGLAS
VERRE TRANSPARENT

| CODICE <i>Code - Artikel - Article</i> | Formato (cm) <i>Size - Format - Dimension</i> | Estensibilità <i>Extensibility - Streckbarkeit - Extensibilité</i> | *Prezzo (€) <i>Price - Preis - Prix</i> | E <i>cm</i> | Singolo lato <i>Single side Einzel Seite - Seul côté</i> |
|---|--|---|--|----------------|---|
| LASP3 70 QI | 70 | 67,5 ÷ 69 | 428,00 | 17,5 | • |
| LASP3 75 QI | 75 | 72,5 ÷ 74 | 475,00 | 19,3 | • |
| LASP3 80 QI | 80 | 77,5 ÷ 79 | 466,00 | 21,0 | • |
| LASP3 90 QI | 90 | 87,5 ÷ 89 | 473,00 | 24,5 | • |
| LASP3 95 QI | 95 | 92,5 ÷ 94 | 521,00 | 26,3 | • |
| LASP3 100 QI | 100 | 97,5 ÷ 99 | 500,00 | 28,0 | • |
| LASP3 105 QI | 105 | 102,5 ÷ 104 | 545,00 | 29,8 | • |
| LASP3 110 QI | 110 | 107,5 ÷ 109 | 556,00 | 31,5 | • |
| LASP3 115 QI | 115 | 112,5 ÷ 114 | 568,00 | 33,3 | • |
| LASP3 120 QI | 120 | 117,5 ÷ 119 | 578,00 | 35,0 | • |
| LASP3 130 QI | 130 | 127,5 ÷ 129 | 627,00 | 35,0 | • |
| LASP3 140 QI | 140 | 137,5 ÷ 139 | 628,00 | 35,0 | • |

*E: Spazio utile entrata - Entrance - Eingang - Entrée

L Sommare i valori dei singoli lati - Sum the value of each side -

Den Wert der einzelnen Seite addieren - Additionner la valeur de chaque côté

*Prezzo: ATTENZIONE il prezzo è relativo ad un singolo lato.

*Price: NOTICE: Price is for 1 side only.

*Preis: VORSICHT: Der Preis ist für eine einzelne Seite.

*Prix: ATTENTION: le prix est pour un seul côté.

PROFILO MAGGIORE ESTENSIBILITÀ

Wall profile adjustment - Verlängerungsprofil - Profilé pour extension supplémentaire

| Codice - Code Artikel - Article | Formato (cm) - Size Format - Dimension | + cm. | Prezzo (€) - Price Preis - Prix |
|------------------------------------|---|-------|------------------------------------|
| MTP 31 QI | 4,2 x 200 | 1,5 | 88,00 |

Possibilità di formare 3° lato con modello LPF3 (pag. 339).

The 3rd side can be made with the LPF3 model (page 339).

Möglichkeit die 3. Seitenwand mit LPF3-Modell (S. 339) einzubauen.

Possibilité de réaliser le 3e côté avec le modèle LPF3 (page 339).

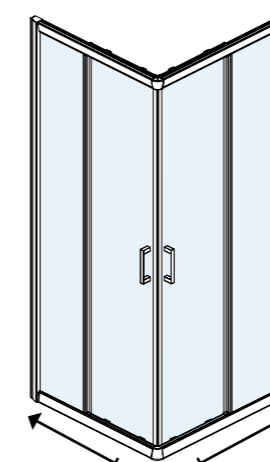

PROFILO A MURO
WALL PROFILE - WANDPROFIL - PROFIL DE MUR

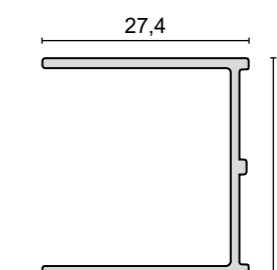

TRATTAMENTO ANTICALCARE

Descaling
Entkalkungsbehandlung
Traitement anticalcaire



VULCANO EVO MATT

CRISTALLO SATINATO
MATT CRYSTAL
SATINIERTES KRISTALLGLAS
VERRE MAT

| CODICE <i>Code - Artikel - Article</i> | Formato (cm) <i>Size - Format - Dimension</i> | Estensibilità <i>Extensibility - Streckbarkeit - Extensibilité</i> | *Prezzo (€) <i>Price - Preis - Prix</i> | E <i>cm</i> | Singolo lato <i>Single side Einzel Seite - Seul côté</i> |
|---|--|---|--|----------------|---|
| LASP3 70M QI | 70 | 67,5 ÷ 69 | 510,00 | 17,5 | • |
| LASP3 75M QI | 75 | 72,5 ÷ 74 | 529,00 | 19,3 | • |
| LASP3 80M QI | 80 | 77,5 ÷ 79 | 546,00 | 21,0 | • |
| LASP3 90M QI | 90 | 87,5 ÷ 89 | 580,00 | 24,5 | • |
| LASP3 100M QI | 100 | 97,5 ÷ 99 | 612,00 | 28,0 | • |
| LASP3 110M QI | 110 | 107,5 ÷ 109 | 650,00 | 31,5 | • |
| LASP3 115M QI | 115 | 112,5 ÷ 114 | 662,00 | 33,3 | • |
| LASP3 120M QI | 120 | 117,5 ÷ 119 | 679,00 | 35,0 | • |
| LASP3 130M QI | 130 | 127,5 ÷ 129 | 714,00 | 35,0 | • |
| LASP3 140M QI | 140 | 137,5 ÷ 139 | 752,00 | 35,0 | • |

*E: Spazio utile entrata - Entrance - Eingang - Entrée

↳ Sommare i valori dei singoli lati - Sum the value of each side -

Den Wert der einzelnen Seite addieren - Additionner la valeur de chaque côté

***Prezzo: ATTENZIONE il prezzo è relativo ad un singolo lato.**

*Price: NOTICE: Price is for 1 side only.

*Preis: VORSICHT: Der Preis ist für eine einzelne Seite.

*Prix: ATTENTION: le prix est pour un seul côté.

6 mm
SCORREVOLI
SLIDING

PROFILO MAGGIORE ESTENSIBILITÀ

Wall profile adjustment - Verlängerungsprofil - Profilé pour extension supplémentaire

| Codice - Code Artikel - Article | Formato (cm) - Size Format - Dimension | + cm. | Prezzo (€) - Price Preis - Prix |
|------------------------------------|---|-------|------------------------------------|
| MTP 31 QI | 4,2 x 200 | 1,5 | 88,00 |

Possibilità di formare 3° lato con modello LPF3 M (pag. 341).

The 3rd side can be made with the LPF3 M model (page 341).

Möglichkeit die 3. Seitenwand mit LPF3 M-Modell (S. 341) einzubauen.

Possibilité de réaliser le 3e côté avec le modèle LPF3 M (page 341).

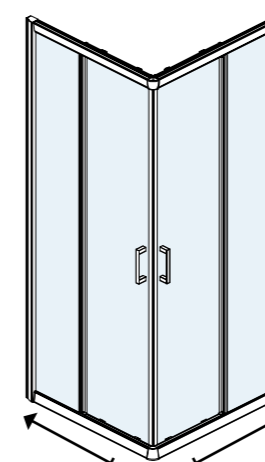

PROFILO A MURO WALL PROFILE - WANDPROFIL - PROFIL DE MUR

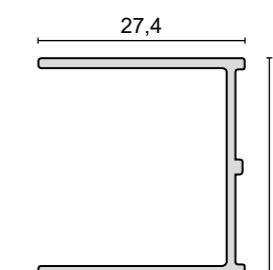

TRATTAMENTO ANTICALCARE

Descaling
Entkalkungsbehandlung
Traitement anticalcaire



VULCANO EVO FOX

CRISTALLO PIUMATO
FOX CRYSTAL
FOX KRISTALLGLAS
VERRE GRANITÉ

| CODICE <i>Code - Artikel - Article</i> | Formato (cm) <i>Size - Format - Dimension</i> | Estensibilità <i>Extensibility - Streckbarkeit - Extensibilité</i> | *Prezzo (€) <i>Price - Preis - Prix</i> | E <i>cm</i> | Singolo lato <i>Single side Einzel Seite - Seul côté</i> |
|---|--|---|--|----------------|---|
| LASP3 70F QI | 70 | 67,5 ÷ 69 | 510,00 | 17,5 | • |
| LASP3 75F QI | 75 | 72,5 ÷ 74 | 529,00 | 19,3 | • |
| LASP3 80F QI | 80 | 77,5 ÷ 79 | 546,00 | 21,0 | • |
| LASP3 90F QI | 90 | 87,5 ÷ 89 | 580,00 | 24,5 | • |
| LASP3 100F QI | 100 | 97,5 ÷ 99 | 612,00 | 28,0 | • |
| LASP3 110F QI | 110 | 107,5 ÷ 109 | 650,00 | 31,5 | • |
| LASP3 115F QI | 115 | 112,5 ÷ 114 | 662,00 | 33,3 | • |
| LASP3 120F QI | 120 | 117,5 ÷ 119 | 679,00 | 35,0 | • |
| LASP3 130F QI | 130 | 127,5 ÷ 129 | 714,00 | 35,0 | • |
| LASP3 140F QI | 140 | 137,5 ÷ 139 | 752,00 | 35,0 | • |

*E: Spazio utile entrata - Entrance - Eingang - Entrée

↳ Sommare i valori dei singoli lati - Sum the value of each side -

Den Wert der einzelnen Seite addieren - Additionner la valeur de chaque côté

*Prezzo: ATTENZIONE il prezzo è relativo ad un singolo lato.

*Price: NOTICE: Price is for 1 side only.

*Preis: VORSICHT: Der Preis ist für eine einzelne Seite.

*Prix: ATTENTION: le prix est pour un seul côté.

PROFILO MAGGIORE ESTENSIBILITÀ

Wall profile adjustment - Verlängerungsprofil - Profilé pour extension supplémentaire

| Codice - Code Artikel - Article | Formato (cm) - Size Format - Dimension | + cm. | Prezzo (€) - Price Preis - Prix |
|------------------------------------|---|-------|------------------------------------|
| MTP 31 QI | 4,2 x 200 | 1,5 | 88,00 |

Possibilità di formare 3° lato con modello LPF3 F (pag. 341).

The 3rd side can be made with the LPF3 F model (page 341).

Möglichkeit die 3. Seitenwand mit LPF3 F-Modell (S. 341) einzubauen.

Possibilité de réaliser le 3e côté avec le modèle LPF3 F (page 341).

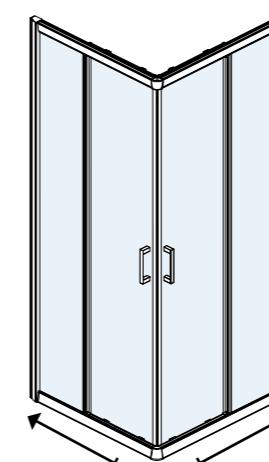
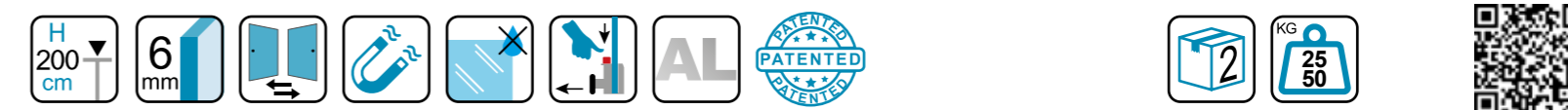

PROFILO A MURO WALL PROFILE - WANDPROFIL - PROFIL DE MUR

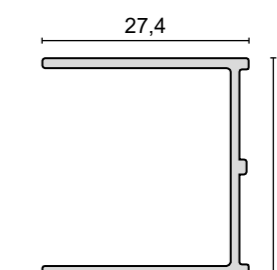

TRATTAMENTO ANTICALCARE

Descaling
Entkalkungsbehandlung
Traitement anticalcaire



VULCANO EVO

CRISTALLO TRASPARENTE
TRANSPARENT CRYSTAL
TRANSPARENTES KRISTALLGLAS
VERRE TRANSPARENT

| CODICE <small>Code - Artikel - Article</small> | Formato (cm) <small>Size - Format - Dimension</small> | Estensibilità <small>Extensibility - Streckbarkeit - Extensibilité</small> | Prezzo (€) <small>Price - Preis - Prix</small> | E <small>cm</small> | *R <small>(cm)</small> |
|---|--|---|---|------------------------|---------------------------|
| LSSP3 7546 QI | 75 x 75 | 72,5÷74 x 72,5÷74 | 848,00 | 42,2 | 38,0 |
| LSSP3 7946 QI | 70 x 90 | 67,5÷69 x 87,5÷89 | 898,00 | 39,0 | 38,0 |
| LSSP3 8046 QI | 80 x 80 | 77,5÷79 x 77,5÷79 | 890,00 | 39,0 | 55,0 |
| LSSP3 8146 QI | 80 x 100 | 77,5÷79 x 97,5÷99 | 950,00 | 42,2 | 38,0 |
| LSSP3 9046 QI | 90 x 90 | 87,5÷89 x 87,5÷89 | 927,00 | 54,0 | 55,0 |

*R: Raggio di curvatura - Radius - Krümmungsradius - Rayon de courbure

6 mm
SCORREVOLI
SLIDING

PROFILO MAGGIORE ESTENSIBILITÀ

Wall profile adjustment - Verlängerungsprofil - Profilé pour extension supplémentaire

| Codice - Code Artikel - Article | Formato (cm) - Size Format - Dimension | + cm. | Prezzo (€) - Price Preis - Prix |
|------------------------------------|---|-------|------------------------------------|
| MTP 31 QI | 4,2 x 200 | 1,5 | 88,00 |

Possibilità di formare 3° lato con modello LPF3 (pag. 339).
The 3rd side can be made with the LPF3 model (page 339).
Möglichkeit die 3. Seitenwand mit LPF3-Modell (S. 339) einzubauen.
Possibilité de réaliser le 3e côté avec le modèle LPF3 (page 339).

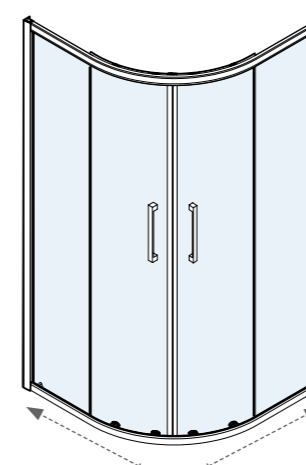

PROFILO A MURO
WALL PROFILE - WANDPROFIL - PROFIL DE MUR

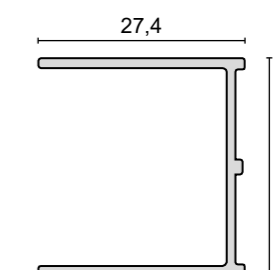

TRATTAMENTO
ANTICALCARE

Descaling
Entkalkungsbehandlung
Traitement anticalcaire



VULCANO EVO MATT

CRISTALLO SATINATO
MATT CRYSTAL
SATINIERTES KRISTALLGLAS
VERRE MAT

| CODICE <i>Code - Artikel - Article</i> | Formato (cm) <i>Size - Format - Dimension</i> | Estensibilità <i>Extensibility - Streckbarkeit - Extensibilité</i> | Prezzo (€) <i>Price - Preis - Prix</i> | E <i>cm</i> | *R <i>(cm)</i> |
|---|--|---|---|----------------|-------------------|
| LSSP3 7946M QI | 70 x 90 | 67,5÷69 x 87,5÷89 | 993,00 | 39,0 | 38,0 |
| LSSP3 8046M QI | 80 x 80 | 77,5÷79 x 77,5÷79 | 985,00 | 39,0 | 55,0 |
| LSSP3 9046M QI | 90 x 90 | 87,5÷89 x 87,5÷89 | 1.033,00 | 54,0 | 55,0 |

*R: Raggio di curvatura - Radius - Krümmungsradius - Rayon de courbure

PROFILO MAGGIORE ESTENSIBILITÀ

Wall profile adjustment - Verlängerungsprofil - Profilé pour extension supplémentaire

| Codice - Code Artikel - Article | Formato (cm) - Size Format - Dimension | + cm. | Prezzo (€) - Price Preis - Prix |
|------------------------------------|---|-------|------------------------------------|
| MTP 31 QI | 4,2 x 200 | 1,5 | 88,00 |

Possibilità di formare 3° lato con modello LPF3 M (pag. 341).
The 3rd side can be made with the LPF3 M model (page 341).
Möglichkeit die 3. Seitenwand mit LPF3 M -Modell (S. 341) einzubauen.
Possibilité de réaliser le 3e côté avec le modèle LPF3 M (page 341).

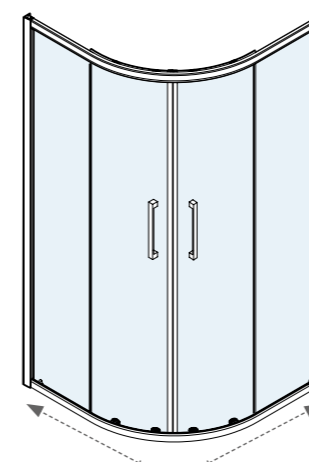
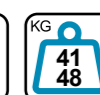
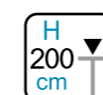

PROFILO A MURO
WALL PROFILE - WANDPROFIL - PROFIL DE MUR

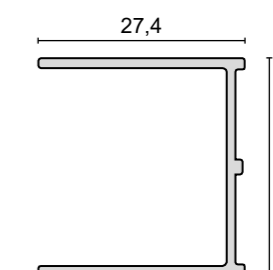

TRATTAMENTO
ANTICALCARE

Descaling
Entkalkungsbehandlung
Traitement anticalcaire

VULCANO EVO FOX

CRISTALLO PIUMATO
FOX CRYSTAL
FOX KRISTALLGLAS
VERRE GRANITÉ

| CODICE <i>Code - Artikel - Article</i> | Formato (cm) <i>Size - Format - Dimension</i> | Estensibilità <i>Extensibility - Streckbarkeit - Extensibilité</i> | Prezzo (€) <i>Price - Preis - Prix</i> | E <i>cm</i> | *R <i>(cm)</i> |
|---|--|---|---|----------------|-------------------|
| LSSP3 7946F QI | 70 x 90 | 67,5÷69 x 87,5÷89 | 993,00 | 39,0 | 38,0 |
| LSSP3 8046F QI | 80 x 80 | 77,5÷79 x 77,5÷79 | 985,00 | 39,0 | 55,0 |
| LSSP3 9046F QI | 90 x 90 | 87,5÷89 x 87,5÷89 | 1.033,00 | 54,0 | 55,0 |

*R: Raggio di curvatura - Radius - Krümmungsradius - Rayon de courbure

PROFILO MAGGIORE ESTENSIBILITÀ

Wall profile adjustment - Verlängerungsprofil - Profilé pour extension supplémentaire

| Codice - Code Artikel - Article | Formato (cm) - Size Format - Dimension | + cm. | Prezzo (€) - Price Preis - Prix |
|------------------------------------|---|-------|------------------------------------|
| MTP 31 QI | 4,2 x 200 | 1,5 | 88,00 |

Possibilità di formare 3° lato con modello LPF3 F QI (pag. 341).
The 3rd side can be made with the LPF3 F QI model (page 341).
Möglichkeit die 3. Seitenwand mit LPF3 F QI-Modell (S. 341) einzubauen.
Possibilité de réaliser le 3e côté avec le modèle LPF3 F QI (page 341).

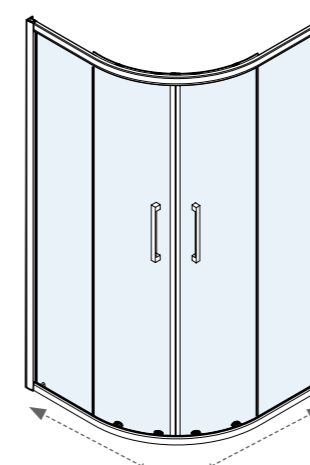

PROFILO A MURO
WALL PROFILE - WANDPROFIL - PROFIL DE MUR

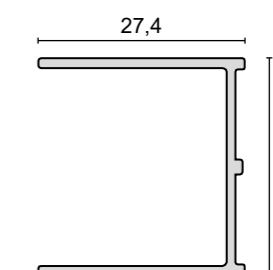

TRATTAMENTO ANTICALCARE

Descaling
Kalkungsbehandlung
Traitement anticalcaire



LIPARI EVO BT

PROFILO NERO SATINATO - CRISTALLO TRASPARENTE

BLACK SATIN PROFILE - TRANSPARENT CRYSTAL
SCHWARZ-SATINIERTES PROFIL - TRANSPARENTES KRISTALLGLAS
PROFILÉ NOIR SATINÉ - VERRE TRANSPARENT

| CODICE <small>Code - Artikel - Article</small> | Formato (cm) <small>Size - Format - Dimension</small> | Estensibilità <small>Extensibility - Streckbarkeit - Extensibilité</small> | Prezzo unitario <small>Price - Preis - Prix</small> | E <small>cm</small> | Lato porta <small>Door - Tür - Porte</small> |
|---|--|---|--|-------------------------------|---|
| LASP3N 9026BT QI | 90 | 87,5 ÷ 90,5 | 703,00 | 34,7 | • |
| LASP3N 10026BT QI | 100 | 97,5 ÷ 100,5 | 737,00 | 39,7 | • |
| LASP3N 11026BT QI | 110 | 107,5 ÷ 110,5 | 772,00 | 44,7 | • |
| LASP3N 12026BT QI | 120 | 117,5 ÷ 120,5 | 806,00 | 49,7 | • |
| LASP3N 13026BT QI | 130 | 127,5 ÷ 130,5 | 838,00 | 49,7 | • |
| LASP3N 14026BT QI | 140 | 137,5 ÷ 140,5 | 883,00 | 49,7 | • |
| LASP3N 15026BT QI | 150 | 147,5 ÷ 150,5 | 931,00 | 59,5 | • |
| LASP3N 16026BT QI | 160 | 157,5 ÷ 160,5 | 955,00 | 59,5 | • |

6 mm
SCORREVOLI
SLIDING

PROFILO MAGGIORE ESTENSIBILITÀ

Wall profile adjustment - Verlängerungsprofil - Profilé pour extension supplémentaire

| Codice - Code Artikel - Article | Formato (cm) - Size Format - Dimension | + cm. | Prezzo (€) - Price Preis - Prix |
|------------------------------------|---|-------|------------------------------------|
| MTP 31B QI | 4,2 x 200 | 1,5 | 88,00 |

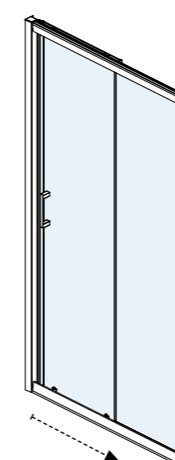
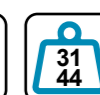

PROFILO A MURO
WALL PROFILE - WANDPROFIL - PROFIL DE MUR

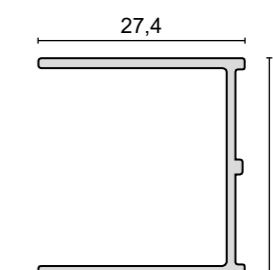

TRATTAMENTO ANTICALCARE

Descaling
Entkalkungsbehandlung
Traitement anticalcaire

LIPARI EVO BT

PROFILO NERO SATINATO - CRISTALLO TRASPARENTE

BLACK SATIN PROFILE - TRANSPARENT CRYSTAL
SCHWARZ-SATINIERTES PROFIL - TRANSPARENTES KRISTALLGLAS
PROFILÉ NOIR SATINÉ - VERRRE TRANSPARENT

| CODICE Code - Artikel - Article | Formato (cm) Size - Format - Dimension | Estensibilità Extensibility - Streckbarkeit - Extensibilité | Prezzo unitario Price - Preis - Prix | E cm | Lato porta Door - Tür - Porte |
|---|--|---|--|----------------|---|
| LASP3N 9026BT QI | 90 | 87,5 ÷ 90,5 | 703,00 | 34,7 | • |
| LASP3N 10026BT QI | 100 | 97,5 ÷ 100,5 | 737,00 | 39,7 | • |
| LASP3N 11026BT QI | 110 | 107,5 ÷ 110,5 | 772,00 | 44,7 | • |
| LASP3N 12026BT QI | 120 | 117,5 ÷ 120,5 | 806,00 | 49,7 | • |
| LASP3N 13026BT QI | 130 | 127,5 ÷ 130,5 | 838,00 | 49,7 | • |
| LASP3N 14026BT QI | 140 | 137,5 ÷ 140,5 | 883,00 | 49,7 | • |
| LASP3N 15026BT QI | 150 | 147,5 ÷ 150,5 | 931,00 | 59,5 | • |
| LASP3N 16026BT QI | 160 | 157,5 ÷ 160,5 | 955,00 | 59,5 | • |

Parete fissa - Pezzi da ordinare
Side - Necessary pieces
Seite - Notwendige Stücke
Paroi fixe - Paroi à commander

| | | | | |
|----------------|----|-----------|--------|---|
| LPF3 7016BT QI | 70 | 67,5 ÷ 69 | 391,00 | 1 |
| LPF3 7516BT QI | 75 | 72,5 ÷ 74 | 407,00 | 1 |
| LPF3 8016BT QI | 80 | 77,5 ÷ 79 | 424,00 | 1 |
| LPF3 9016BT QI | 90 | 87,5 ÷ 89 | 459,00 | 1 |

PROFILO MAGGIORE ESTENSIBILITÀ

Wall profile adjustment - Verlängerungsprofil - Profilé pour extension supplémentaire

| Codice - Code Artikel - Article | Formato (cm) - Size Format - Dimension | + cm. | Prezzo (€) - Price Preis - Prix |
|---|--|--------------|---|
| MTP 31B QI | 4,2 x 200 | 1,5 | 88,00 |

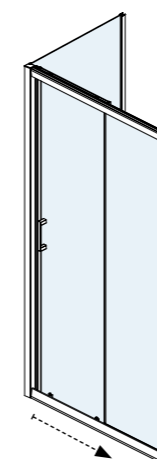
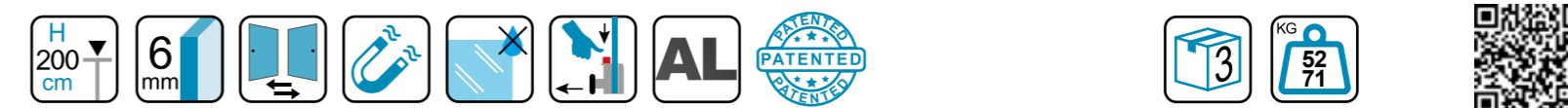

PROFILO A MURO
WALL PROFILE - WANDPROFIL - PROFIL DE MUR

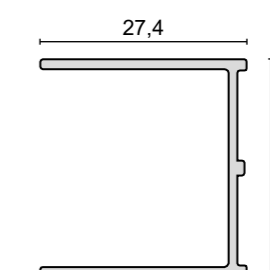

TRATTAMENTO ANTICALCARE

Descaling
Entkalkungsbehandlung
Traitement anticalcaire

LIPARI EVO BT

PROFILO NERO SATINATO - CRISTALLO TRASPARENTE

BLACK SATIN PROFILE - TRANSPARENT CRYSTAL
SCHWARZ-SATINIERTES PROFIL - TRANSPARENTES KRISTALLGLAS
PROFILÉ NOIR SATINÉ - VERRRE TRANSPARENT

| CODICE <small>Code - Artikel - Article</small> | Formato (cm) <small>Size - Format - Dimension</small> | Estensibilità <small>Extensibility - Streckbarkeit - Extensibilité</small> | Prezzo unitario <small>Price - Preis - Prix</small> | E <small>cm</small> | Lato porta <small>Door - Tür - Porte</small> |
|---|--|---|--|-------------------------------|---|
| LASP3N 9026BT QI | 90 | 87,5 ÷ 90,5 | 703,00 | 34,7 | • |
| LASP3N 10026BT QI | 100 | 97,5 ÷ 100,5 | 737,00 | 39,7 | • |
| LASP3N 11026BT QI | 110 | 107,5 ÷ 110,5 | 772,00 | 44,7 | • |
| LASP3N 12026BT QI | 120 | 117,5 ÷ 120,5 | 806,00 | 49,7 | • |
| LASP3N 13026BT QI | 130 | 127,5 ÷ 130,5 | 838,00 | 49,7 | • |
| LASP3N 14026BT QI | 140 | 137,5 ÷ 140,5 | 883,00 | 49,7 | • |
| LASP3N 15026BT QI | 150 | 147,5 ÷ 150,5 | 931,00 | 59,5 | • |
| LASP3N 16026BT QI | 160 | 157,5 ÷ 160,5 | 955,00 | 59,5 | • |

Parete fissa - Pezzi da ordinare
Side - Necessary pieces
Seite - Notwendige Stücke
Paroi fixe - Paroi à commander

| | | | | |
|----------------|----|-----------|--------|---|
| LPF3 7016BT QI | 70 | 67,5 ÷ 69 | 391,00 | 2 |
| LPF3 7516BT QI | 75 | 72,5 ÷ 74 | 407,00 | 2 |
| LPF3 8016BT QI | 80 | 77,5 ÷ 79 | 424,00 | 2 |
| LPF3 9016BT QI | 90 | 87,5 ÷ 89 | 459,00 | 2 |

PROFILO MAGGIORE ESTENSIBILITÀ

Wall profile adjustment - Verlängerungsprofil - Profilé pour extension supplémentaire

| Codice - Code Artikel - Article | Formato (cm) - Size Format - Dimension | + cm. | Prezzo (€) - Price Preis - Prix |
|------------------------------------|---|-------|------------------------------------|
| MTP 31B QI | 4,2 x 200 | 1,5 | 88,00 |

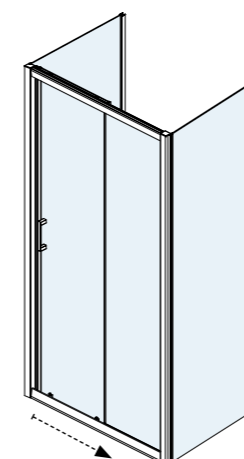

PROFILO A MURO
WALL PROFILE - WANDPROFIL - PROFIL DE MUR

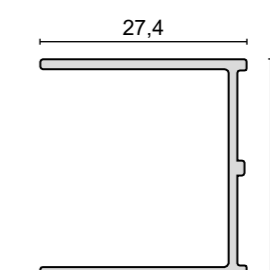

TRATTAMENTO ANTICALCARE

Descaling
Entkalkungsbehandlung
Traitement anticalcaire



LIPARI EVO

CRISTALLO TRASPARENTE
TRANSPARENT CRYSTAL
TRANSPARENTES KRISTALLGLAS
VERRE TRANSPARENT

| CODICE <i>Code - Artikel - Article</i> | Formato (cm) <i>Size - Format - Dimension</i> | Estensibilità <i>Extensibility - Streckbarkeit - Extensibilité</i> | Prezzo unitario <i>Price - Preis - Prix</i> | E <i>cm</i> | Lato porta <i>Door - Tür - Porte</i> |
|--|---|--|---|-----------------------|--|
| LASP3N 9026 QI | 90 | 87,5 ÷ 90,5 | 563,00 | 34,7 | • |
| LASP3N 9526 QI | 95 | 92,5 ÷ 95,5 | 581,00 | 37,2 | • |
| LASP3N 10026 QI | 100 | 97,5 ÷ 100,5 | 588,00 | 39,7 | • |
| LASP3N 10526 QI | 105 | 102,5 ÷ 105,5 | 611,00 | 42,2 | • |
| LASP3N 11026 QI | 110 | 107,5 ÷ 110,5 | 616,00 | 44,7 | • |
| LASP3N 11526 QI | 115 | 112,5 ÷ 115,5 | 621,00 | 47,2 | • |
| LASP3N 12026 QI | 120 | 117,5 ÷ 120,5 | 639,00 | 49,7 | • |
| LASP3N 13026 QI | 130 | 127,5 ÷ 130,5 | 739,00 | 49,7 | • |
| LASP3N 14026 QI | 140 | 137,5 ÷ 140,5 | 740,00 | 49,7 | • |
| LASP3N 15026 QI | 150 | 147,5 ÷ 150,5 | 829,00 | 59,5 | • |
| LASP3N 16026 QI | 160 | 157,5 ÷ 160,5 | 874,00 | 59,5 | • |

6 mm
SCORREVOLI
SLIDING

PROFILO MAGGIORE ESTENSIBILITÀ

Wall profile adjustment - Verlängerungsprofil - Profilé pour extension supplémentaire

| Codice - Code <i>Artikel - Article</i> | Formato (cm) - Size <i>Format - Dimension</i> | + cm. | Prezzo (€) - Price <i>Preis - Prix</i> |
|--|---|--------------|--|
| MTP 31 QI | 4,2 x 200 | 1,5 | 88,00 |

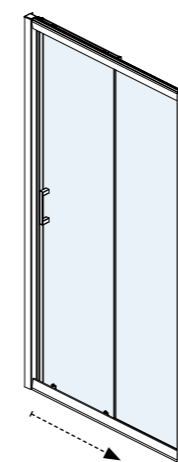
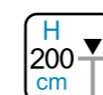

PROFILO A MURO WALL PROFILE - WANDPROFIL - PROFIL DE MUR

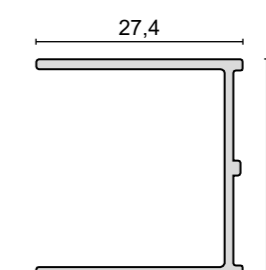

TRATTAMENTO ANTICALCARE

Descaling
Entkalkungsbehandlung
Traitement anticalcaire

LIPARI EVO

CRISTALLO TRASPARENTE
TRANSPARENT CRYSTAL
TRANSPARENTES KRISTALLGLAS
VERRE TRANSPARENT

| CODICE Code - Artikel - Article | Formato (cm) Size - Format - Dimension | Estensibilità Extensibility - Streckbarkeit - Extensibilité | Prezzo unitario Price - Preis - Prix | E cm | Lato porta Door - Tür - Porte |
|---|--|---|--|----------------|---|
| LASP3N 9026 QI | 90 | 87,5 ÷ 90,5 | 563,00 | 34,7 | • |
| LASP3N 9526 QI | 95 | 92,5 ÷ 95,5 | 581,00 | 37,2 | • |
| LASP3N 10026 QI | 100 | 97,5 ÷ 100,5 | 588,00 | 39,7 | • |
| LASP3N 10526 QI | 105 | 102,5 ÷ 105,5 | 611,00 | 42,2 | • |
| LASP3N 11026 QI | 110 | 107,5 ÷ 110,5 | 616,00 | 44,7 | • |
| LASP3N 11526 QI | 115 | 112,5 ÷ 115,5 | 621,00 | 47,2 | • |
| LASP3N 12026 QI | 120 | 117,5 ÷ 120,5 | 639,00 | 49,7 | • |
| LASP3N 13026 QI | 130 | 127,5 ÷ 130,5 | 739,00 | 49,7 | • |
| LASP3N 14026 QI | 140 | 137,5 ÷ 140,5 | 740,00 | 49,7 | • |
| LASP3N 15026 QI | 150 | 147,5 ÷ 150,5 | 829,00 | 59,5 | • |
| LASP3N 16026 QI | 160 | 157,5 ÷ 160,5 | 874,00 | 59,5 | • |

Parete fissa - Pezzi da ordinare
Side - Necessary pieces
Seite - Notwendige Stücke
Paroi fixe - Paroi à commander

| | | | | |
|---------------|-----|-----------|--------|---|
| LPF3 6516 QI | 65 | 62,5 ÷ 64 | 303,00 | 1 |
| LPF3 7016 QI | 70 | 67,5 ÷ 69 | 316,00 | 1 |
| LPF3 7516 QI | 75 | 72,5 ÷ 74 | 336,00 | 1 |
| LPF3 8016 QI | 80 | 77,5 ÷ 79 | 344,00 | 1 |
| LPF3 9016 QI | 90 | 87,5 ÷ 89 | 372,00 | 1 |
| LPF3 10016 QI | 100 | 97,5 ÷ 99 | 436,00 | 1 |

PROFILO MAGGIORE ESTENSIBILITÀ

Wall profile adjustment - Verlängerungsprofil - Profilé pour extension supplémentaire

| Codice - Code Artikel - Article | Formato (cm) - Size Format - Dimension | + cm. | Prezzo (€) - Price Preis - Prix |
|---|--|--------------|---|
| MTP 31 QI | 4,2 x 200 | 1,5 | 88,00 |

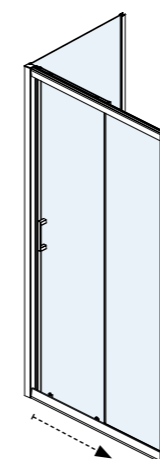

PROFILO A MURO WALL PROFILE - WANDPROFIL - PROFIL DE MUR

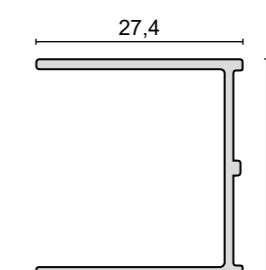

TRATTAMENTO ANTICALCARE

Descaling
Entkalkungsbehandlung
Traitement anticalcaire

LIPARI EVO

CRISTALLO TRASPARENTE
TRANSPARENT CRYSTAL
TRANSPARENTES KRISTALLGLAS
VERRE TRANSPARENT

| CODICE <i>Code - Artikel - Article</i> | Formato (cm) <i>Size - Format - Dimension</i> | Estensibilità <i>Extensibility - Streckbarkeit - Extensibilité</i> | Prezzo unitario <i>Price - Preis - Prix</i> | E <i>cm</i> | Lato porta <i>Door - Tür - Porte</i> |
|--|---|--|---|-----------------------|--|
| LASP3N 9026 QI | 90 | 87,5 ÷ 90,5 | 563,00 | 34,7 | • |
| LASP3N 9526 QI | 95 | 92,5 ÷ 95,5 | 581,00 | 37,2 | • |
| LASP3N 10026 QI | 100 | 97,5 ÷ 100,5 | 588,00 | 39,7 | • |
| LASP3N 10526 QI | 105 | 102,5 ÷ 105,5 | 611,00 | 42,2 | • |
| LASP3N 11026 QI | 110 | 107,5 ÷ 110,5 | 616,00 | 44,7 | • |
| LASP3N 11526 QI | 115 | 112,5 ÷ 115,5 | 621,00 | 47,2 | • |
| LASP3N 12026 QI | 120 | 117,5 ÷ 120,5 | 639,00 | 49,7 | • |
| LASP3N 13026 QI | 130 | 127,5 ÷ 130,5 | 739,00 | 49,7 | • |
| LASP3N 14026 QI | 140 | 137,5 ÷ 140,5 | 740,00 | 49,7 | • |
| LASP3N 15026 QI | 150 | 147,5 ÷ 150,5 | 829,00 | 59,5 | • |
| LASP3N 16026 QI | 160 | 157,5 ÷ 160,5 | 874,00 | 59,5 | • |

Parete fissa - Pezzi da ordinare
Side - Necessary pieces
Seite - Notwendige Stücke
Paroi fixe - Paroi à commander

| | | | | |
|---------------|-----|-----------|--------|----------|
| LPF3 6516 QI | 65 | 62,5 ÷ 64 | 303,00 | 2 |
| LPF3 7016 QI | 70 | 67,5 ÷ 69 | 316,00 | 2 |
| LPF3 7516 QI | 75 | 72,5 ÷ 74 | 336,00 | 2 |
| LPF3 8016 QI | 80 | 77,5 ÷ 79 | 344,00 | 2 |
| LPF3 9016 QI | 90 | 87,5 ÷ 89 | 372,00 | 2 |
| LPF3 10016 QI | 100 | 97,5 ÷ 99 | 436,00 | 2 |

PROFILO MAGGIORE ESTENSIBILITÀ

Wall profile adjustment - Verlängerungsprofil - Profilé pour extension supplémentaire

| Codice - Code <i>Artikel - Article</i> | Formato (cm) - Size <i>Format - Dimension</i> | + cm. | Prezzo (€) - Price <i>Preis - Prix</i> |
|--|---|--------------|--|
| MTP 31 QI | 4,2 x 200 | 1,5 | 88,00 |

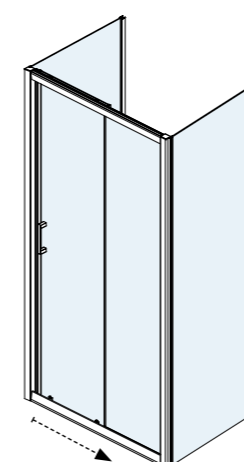

PROFILO A MURO
WALL PROFILE - WANDPROFIL - PROFIL DE MUR

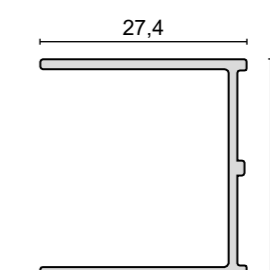

TRATTAMENTO ANTICALCARE

Descaling
Entkalkungsbehandlung
Traitement anticalcaire

LIPARI EVO MATT

CRISTALLO SATINATO
MATT CRYSTAL
SATINIERTES KRISTALLGLAS
VERRE MAT

| CODICE <i>Code - Artikel - Article</i> | Formato (cm) <i>Size - Format - Dimension</i> | Estensibilità <i>Extensibility - Streckbarkeit - Extensibilité</i> | Prezzo unitario <i>Price - Preis - Prix</i> | E cm | Lato porta <i>Door - Tür - Porte</i> |
|---|--|---|--|----------------|---|
| LASP3N 9026M QI | 90 | 87,5 ÷ 90,5 | 612,00 | 34,7 | • |
| LASP3N 10026M QI | 100 | 97,5 ÷ 100,5 | 656,00 | 39,7 | • |
| LASP3N 11026M QI | 110 | 107,5 ÷ 110,5 | 700,00 | 44,7 | • |
| LASP3N 11526M QI | 115 | 112,5 ÷ 115,5 | 717,00 | 47,2 | • |
| LASP3N 12026M QI | 120 | 117,5 ÷ 120,5 | 728,00 | 49,7 | • |
| LASP3N 13026M QI | 130 | 127,5 ÷ 130,5 | 796,00 | 49,7 | • |
| LASP3N 14026M QI | 140 | 137,5 ÷ 140,5 | 840,00 | 49,7 | • |

6 mm
SCORREVOLI
SLIDING

PROFILO MAGGIORE ESTENSIBILITÀ

Wall profile adjustment - Verlängerungsprofil - Profilé pour extension supplémentaire

| Codice - Code Artikel - Article | Formato (cm) - Size Format - Dimension | + cm. | Prezzo (€) - Price Preis - Prix |
|------------------------------------|---|-------|------------------------------------|
| MTP 31 QI | 4,2 x 200 | 1,5 | 88,00 |

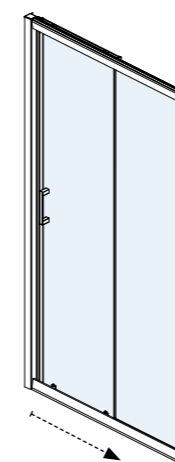

PROFILO A MURO WALL PROFILE - WANDPROFIL - PROFIL DE MUR

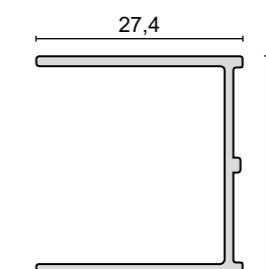

TRATTAMENTO ANTICALCARE

Descaling
Entkalkungsbehandlung
Traitement anticalcaire

LIPARI EVO MATT

CRISTALLO SATINATO
MATT CRYSTAL
SATINIERTES KRISTALLGLAS
VERRE MAT

| CODICE <i>Code - Artikel - Article</i> | Formato (cm) <i>Size - Format - Dimension</i> | Estensibilità <i>Extensibility - Streckbarkeit - Extensibilité</i> | Prezzo unitario <i>Price - Preis - Prix</i> | E cm | Lato porta <i>Door - Tür - Porte</i> |
|---|--|---|--|----------------|---|
| LASP3N 9026M QI | 90 | 87,5 ÷ 90,5 | 612,00 | 34,7 | • |
| LASP3N 10026M QI | 100 | 97,5 ÷ 100,5 | 656,00 | 39,7 | • |
| LASP3N 11026M QI | 110 | 107,5 ÷ 110,5 | 700,00 | 44,7 | • |
| LASP3N 11526M QI | 115 | 112,5 ÷ 115,5 | 717,00 | 47,2 | • |
| LASP3N 12026M QI | 120 | 117,5 ÷ 120,5 | 728,00 | 49,7 | • |
| LASP3N 13026M QI | 130 | 127,5 ÷ 130,5 | 796,00 | 49,7 | • |
| LASP3N 14026M QI | 140 | 137,5 ÷ 140,5 | 840,00 | 49,7 | • |

Parete fissa - Pezzi da ordinare
Side - Necessary pieces
Seite - Notwendige Stücke
Paroi fixe - Paroi à commander

| | | | | |
|---------------|----|-----------|--------|---|
| LPF3 7016M QI | 70 | 67,5 ÷ 69 | 362,00 | 1 |
| LPF3 7516M QI | 75 | 72,5 ÷ 74 | 392,00 | 1 |
| LPF3 8016M QI | 80 | 77,5 ÷ 79 | 397,00 | 1 |
| LPF3 9016M QI | 90 | 87,5 ÷ 89 | 432,00 | 1 |

PROFILO MAGGIORE ESTENSIBILITÀ

Wall profile adjustment - Verlängerungsprofil - Profilé pour extension supplémentaire

| Codice - Code Artikel - Article | Formato (cm) - Size Format - Dimension | + cm. | Prezzo (€) - Price Preis - Prix |
|------------------------------------|---|-------|------------------------------------|
| MTP 31 QI | 4,2 x 200 | 1,5 | 88,00 |

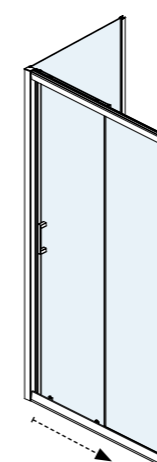

PROFILO A MURO WALL PROFILE - WANDPROFIL - PROFIL DE MUR

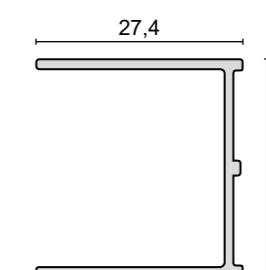

6 mm
SCORREVOLI
SLIDING

TRATTAMENTO ANTICALCARE

Descaling
Entkalkungsbehandlung
Traitement anticalcare

LIPARI EVO MATT

CRISTALLO SATINATO
MATT CRYSTAL
SATINIERTES KRISTALLGLAS
VERRE MAT

| CODICE <i>Code - Artikel - Article</i> | Formato (cm) <i>Size - Format - Dimension</i> | Estensibilità <i>Extensibility - Streckbarkeit - Extensibilité</i> | Prezzo unitario <i>Price - Preis - Prix</i> | E cm | Lato porta <i>Door - Tür - Porte</i> |
|---|--|---|--|----------------|---|
| LASP3N 9026M QI | 90 | 87,5 ÷ 90,5 | 612,00 | 34,7 | • |
| LASP3N 10026M QI | 100 | 97,5 ÷ 100,5 | 656,00 | 39,7 | • |
| LASP3N 11026M QI | 110 | 107,5 ÷ 110,5 | 700,00 | 44,7 | • |
| LASP3N 11526M QI | 115 | 112,5 ÷ 115,5 | 717,00 | 47,2 | • |
| LASP3N 12026M QI | 120 | 117,5 ÷ 120,5 | 728,00 | 49,7 | • |
| LASP3N 13026M QI | 130 | 127,5 ÷ 130,5 | 796,00 | 49,7 | • |
| LASP3N 14026M QI | 140 | 137,5 ÷ 140,5 | 840,00 | 49,7 | • |

Parete fissa - Pezzi da ordinare
Side - Necessary pieces
Seite - Notwendige Stücke
Paroi fixe - Paroi à commander

| | | | | |
|---------------|----|-----------|--------|---|
| LPF3 7016M QI | 70 | 67,5 ÷ 69 | 362,00 | 2 |
| LPF3 7516M QI | 75 | 72,5 ÷ 74 | 392,00 | 2 |
| LPF3 8016M QI | 80 | 77,5 ÷ 79 | 397,00 | 2 |
| LPF3 9016M QI | 90 | 87,5 ÷ 89 | 432,00 | 2 |

PROFILO MAGGIORE ESTENSIBILITÀ

Wall profile adjustment - Verlängerungsprofil - Profilé pour extension supplémentaire

| Codice - Code Artikel - Article | Formato (cm) - Size Format - Dimension | + cm. | Prezzo (€) - Price Preis - Prix |
|------------------------------------|---|-------|------------------------------------|
| MTP 31 QI | 4,2 x 200 | 1,5 | 88,00 |

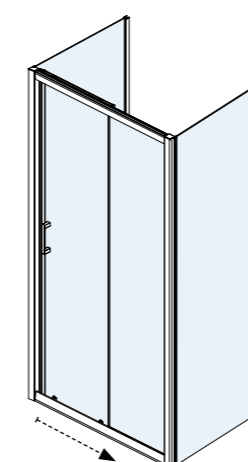

PROFILO A MURO WALL PROFILE - WANDPROFIL - PROFIL DE MUR

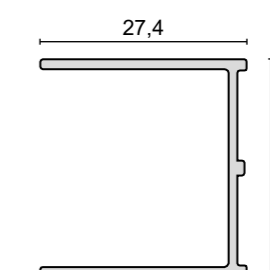

TRATTAMENTO ANTICALCARE

Descaling
Entkalkungsbehandlung
Traitement anticalcaire

LIPARI EVO FOX

CRISTALLO PIUMATO
FOX CRYSTAL
FOX KRISTALLGLAS
VERRE GRANITÉ

| CODICE <i>Code - Artikel - Article</i> | Formato (cm) <i>Size - Format - Dimension</i> | Estensibilità <i>Extensibility - Streckbarkeit - Extensibilité</i> | Prezzo unitario <i>Price - Preis - Prix</i> | E <i>cm</i> | Lato porta <i>Door - Tür - Porte</i> |
|--|---|--|---|-----------------------|--|
| LASP3N 9026F QI | 90 | 87,5 ÷ 90,5 | 612,00 | 34,7 | • |
| LASP3N 10026F QI | 100 | 97,5 ÷ 100,5 | 656,00 | 39,7 | • |
| LASP3N 11026F QI | 110 | 107,5 ÷ 110,5 | 700,00 | 44,7 | • |
| LASP3N 11526F QI | 115 | 112,5 ÷ 115,5 | 717,00 | 47,2 | • |
| LASP3N 12026F QI | 120 | 117,5 ÷ 120,5 | 728,00 | 49,7 | • |
| LASP3N 13026F QI | 130 | 127,5 ÷ 130,5 | 796,00 | 49,7 | • |
| LASP3N 14026F QI | 140 | 137,5 ÷ 140,5 | 840,00 | 49,7 | • |

6 mm
SCORREVOLI
SLIDING

PROFILO MAGGIORE ESTENSIBILITÀ

Wall profile adjustment - Verlängerungsprofil - Profilé pour extension supplémentaire

| Codice - Code <i>Artikel - Article</i> | Formato (cm) - Size <i>Format - Dimension</i> | + cm. | Prezzo (€) - Price <i>Preis - Prix</i> |
|--|---|--------------|--|
| MTP 31 QI | 4,2 x 200 | 1,5 | 88,00 |

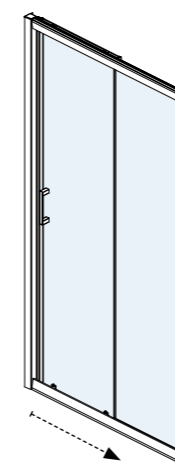

PROFILO A MURO WALL PROFILE - WANDPROFIL - PROFIL DE MUR

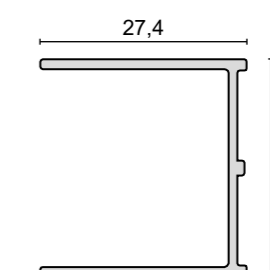

TRATTAMENTO ANTICALCARE

Descaling
Entkalkungsbehandlung
Traitement anticalcaire

LIPARI EVO FOX

CRISTALLO PIUMATO
FOX CRYSTAL
FOX KRISTALLGLAS
VERRE GRANITÉ

| CODICE Code - Artikel - Article | Formato (cm) Size - Format - Dimension | Estensibilità Extensibility - Streckbarkeit - Extensibilité | Prezzo unitario Price - Preis - Prix | E cm | Lato porta Door - Tür - Porte |
|---|--|---|--|----------------|---|
| LASP3N 9026F QI | 90 | 87,5 ÷ 90,5 | 612,00 | 34,7 | • |
| LASP3N 10026F QI | 100 | 97,5 ÷ 100,5 | 656,00 | 39,7 | • |
| LASP3N 11026F QI | 110 | 107,5 ÷ 110,5 | 700,00 | 44,7 | • |
| LASP3N 11526F QI | 115 | 112,5 ÷ 115,5 | 717,00 | 47,2 | • |
| LASP3N 12026F QI | 120 | 117,5 ÷ 120,5 | 728,00 | 49,7 | • |
| LASP3N 13026F QI | 130 | 127,5 ÷ 130,5 | 796,00 | 49,7 | • |
| LASP3N 14026F QI | 140 | 137,5 ÷ 140,5 | 840,00 | 49,7 | • |

Parete fissa - Pezzi da ordinare
Side - Necessary pieces
Seite - Notwendige Stücke
Paroi fixe - Paroi à commander

| | | | | |
|---------------|----|-----------|--------|---|
| LPF3 7016F QI | 70 | 67,5 ÷ 69 | 362,00 | 1 |
| LPF3 7516F QI | 75 | 72,5 ÷ 74 | 392,00 | 1 |
| LPF3 8016F QI | 80 | 77,5 ÷ 79 | 397,00 | 1 |
| LPF3 9016F QI | 90 | 87,5 ÷ 89 | 432,00 | 1 |

PROFILO MAGGIORE ESTENSIBILITÀ

Wall profile adjustment - Verlängerungsprofil - Profilé pour extension supplémentaire

| Codice - Code Artikel - Article | Formato (cm) - Size Format - Dimension | + cm. | Prezzo (€) - Price Preis - Prix |
|---|--|--------------|---|
| MTP 31 QI | 4,2 x 200 | 1,5 | 88,00 |

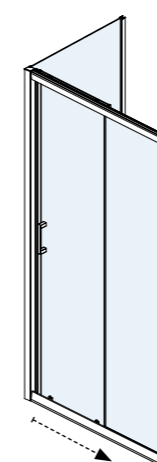

PROFILO A MURO

WALL PROFILE - WANDPROFIL - PROFIL DE MUR

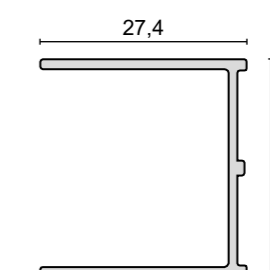

TRATTAMENTO ANTICALCARE

Descaling
Entkalkungsbehandlung
Traitement anticalcare

LIPARI EVO FOX

CRISTALLO PIUMATO
FOX CRYSTAL
FOX KRISTALLGLAS
VERRE GRANITÉ

| CODICE Code - Artikel - Article | Formato (cm) Size - Format - Dimension | Estensibilità Extensibility - Streckbarkeit - Extensibilité | Prezzo unitario Price - Preis - Prix | E cm | Lato porta Door - Tür - Porte |
|---|--|---|--|----------------|---|
| LASP3N 9026F QI | 90 | 87,5 ÷ 90,5 | 612,00 | 34,7 | • |
| LASP3N 10026F QI | 100 | 97,5 ÷ 100,5 | 656,00 | 39,7 | • |
| LASP3N 11026F QI | 110 | 107,5 ÷ 110,5 | 700,00 | 44,7 | • |
| LASP3N 11526F QI | 115 | 112,5 ÷ 115,5 | 717,00 | 47,2 | • |
| LASP3N 12026F QI | 120 | 117,5 ÷ 120,5 | 728,00 | 49,7 | • |
| LASP3N 13026F QI | 130 | 127,5 ÷ 130,5 | 796,00 | 49,7 | • |
| LASP3N 14026F QI | 140 | 137,5 ÷ 140,5 | 840,00 | 49,7 | • |

Parete fissa - Pezzi da ordinare
Side - Necessary pieces
Seite - Notwendige Stücke
Paroi fixe - Paroi à commander

| | | | | |
|---------------|----|-----------|--------|----------|
| LPF3 7016F QI | 70 | 67,5 ÷ 69 | 362,00 | 2 |
| LPF3 7516F QI | 75 | 72,5 ÷ 74 | 392,00 | 2 |
| LPF3 8016F QI | 80 | 77,5 ÷ 79 | 397,00 | 2 |
| LPF3 9016F QI | 90 | 87,5 ÷ 89 | 432,00 | 2 |

PROFILO MAGGIORE ESTENSIBILITÀ

Wall profile adjustment - Verlängerungsprofil - Profilé pour extension supplémentaire

| Codice - Code Artikel - Article | Formato (cm) - Size Format - Dimension | + cm. | Prezzo (€) - Price Preis - Prix |
|---|--|--------------|---|
| MTP 31 QI | 4,2 x 200 | 1,5 | 88,00 |

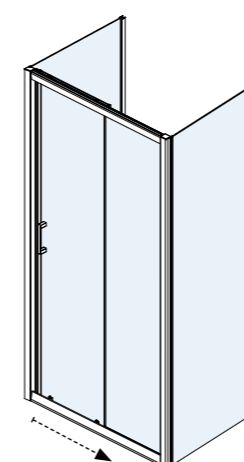

PROFILO A MURO WALL PROFILE - WANDPROFIL - PROFIL DE MUR

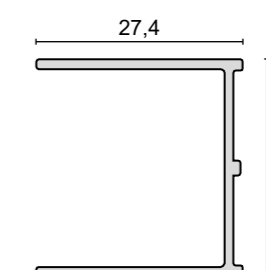

TRATTAMENTO ANTICALCARE

Descaling
Entkalkungsbehandlung
Traitement anticalcaire

STROMBOLI EVO

CRISTALLO TRASPARENTE
TRANSPARENT CRYSTAL
TRANSPARENTES KRISTALLGLAS
VERRE TRANSPARENT

| CODICE <i>Code - Artikel - Article</i> | Formato (cm) <i>Size - Format - Dimension</i> | Estensibilità <i>Extensibility - Streckbarkeit - Extensibilité</i> | Prezzo (€) <i>Price - Preis - Prix</i> | E <i>cm</i> | Lato porta <i>Door - Tür - Porte</i> |
|--|---|--|--|-----------------------|--|
| LPS3 1246 QI | 120 | 117 ÷ 120 | 833,00 | 44,2 | • |
| LPS3 1346 QI | 130 | 127 ÷ 130 | 857,00 | 49,2 | • |
| LPS3 1446 QI | 140 | 137 ÷ 140 | 881,00 | 54,2 | • |
| LPS3 1546 QI | 150 | 147 ÷ 150 | 904,00 | 59,2 | • |
| LPS3 1646 QI | 160 | 157 ÷ 160 | 927,00 | 64,2 | • |
| LPS3 1746 QI | 170 | 167 ÷ 170 | 951,00 | 69,2 | • |
| LPS3 1846 QI | 180 | 177 ÷ 180 | 987,00 | 74,2 | • |

6 mm
SCORREVOLI
SLIDING

PROFILO MAGGIORE ESTENSIBILITÀ

Wall profile adjustment - Verlängerungsprofil - Profilé pour extension supplémentaire

| Codice - Code <i>Artikel - Article</i> | Formato (cm) - Size <i>Format - Dimension</i> | + cm. | Prezzo (€) - Price <i>Preis - Prix</i> |
|--|---|--------------|--|
| MTP 31 QI | 4,2 x 200 | 1,5 | 88,00 |

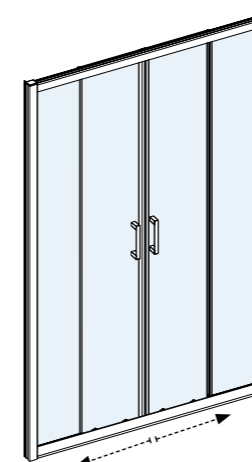

PROFILO A MURO WALL PROFILE - WANDPROFIL - PROFIL DE MUR

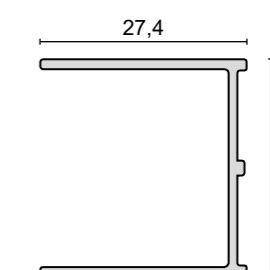

TRATTAMENTO ANTICALCARE

Descaling
Entkalkungsbehandlung
Traitement anticalcaire

STROMBOLI EVO

CRISTALLO TRASPARENTE
TRANSPARENT CRYSTAL
TRANSPARENTES KRISTALLGLAS
VERRE TRANSPARENT

| CODICE <i>Code - Artikel - Article</i> | Formato (cm) <i>Size - Format - Dimension</i> | Estensibilità <i>Extensibility - Streckbarkeit - Extensibilité</i> | Prezzo (€) <i>Price - Preis - Prix</i> | E cm | Lato porta <i>Door - Tür - Porte</i> |
|---|--|---|---|----------------|---|
| LPS3 1246 QI | 120 | 117 ÷ 120 | 833,00 | 44,2 | • |
| LPS3 1346 QI | 130 | 127 ÷ 130 | 857,00 | 49,2 | • |
| LPS3 1446 QI | 140 | 137 ÷ 140 | 881,00 | 54,2 | • |
| LPS3 1546 QI | 150 | 147 ÷ 150 | 904,00 | 59,2 | • |
| LPS3 1646 QI | 160 | 157 ÷ 160 | 927,00 | 64,2 | • |
| LPS3 1746 QI | 170 | 167 ÷ 170 | 951,00 | 69,2 | • |
| LPS3 1846 QI | 180 | 177 ÷ 180 | 987,00 | 74,2 | • |

Parete fissa - Pezzi da ordinare
Side - Necessary pieces
Seite - Notwendige Stücke
Paroi fixe - Paroi à commander

| | | | | |
|---------------|-----|-----------|--------|----------|
| LPF3 6516 QI | 65 | 62,5 ÷ 64 | 303,00 | 1 |
| LPF3 7016 QI | 70 | 67,5 ÷ 69 | 316,00 | 1 |
| LPF3 7516 QI | 75 | 72,5 ÷ 74 | 336,00 | 1 |
| LPF3 8016 QI | 80 | 77,5 ÷ 79 | 344,00 | 1 |
| LPF3 9016 QI | 90 | 87,5 ÷ 89 | 372,00 | 1 |
| LPF3 10016 QI | 100 | 97,5 ÷ 99 | 436,00 | 1 |

PROFILO MAGGIORE ESTENSIBILITÀ

Wall profile adjustment - Verlängerungsprofil - Profilé pour extension supplémentaire

| Codice - Code Artikel - Article | Formato (cm) - Size Format - Dimension | + cm. | Prezzo (€) - Price Preis - Prix |
|------------------------------------|---|------------|------------------------------------|
| MTP 31 QI | 4,2 x 200 | 1,5 | 88,00 |

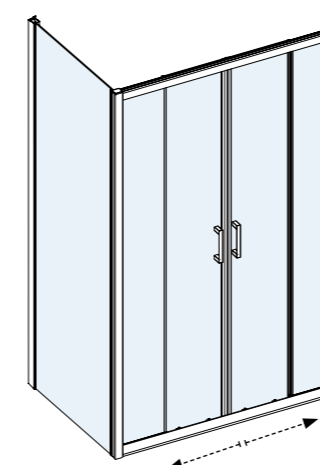

PROFILO A MURO WALL PROFILE - WANDPROFIL - PROFIL DE MUR

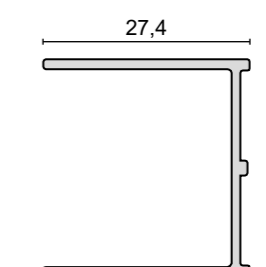

TRATTAMENTO ANTICALCARE

Descaling
Entkalkungsbehandlung
Traitement anticalcaire

STROMBOLI EVO

CRISTALLO TRASPARENTE
TRANSPARENT CRYSTAL
TRANSPARENTES KRISTALLGLAS
VERRE TRANSPARENT

| CODICE Code - Artikel - Article | Formato (cm) Size - Format - Dimension | Estensibilità Extensibility - Streckbarkeit - Extensibilité | Prezzo (€) Price - Preis - Prix | E cm | Lato porta Door - Tür - Porte |
|---|--|---|---|----------------|---|
| LPS3 1246 QI | 120 | 117 ÷ 120 | 833,00 | 44,2 | • |
| LPS3 1346 QI | 130 | 127 ÷ 130 | 857,00 | 49,2 | • |
| LPS3 1446 QI | 140 | 137 ÷ 140 | 881,00 | 54,2 | • |
| LPS3 1546 QI | 150 | 147 ÷ 150 | 904,00 | 59,2 | • |
| LPS3 1646 QI | 160 | 157 ÷ 160 | 927,00 | 64,2 | • |
| LPS3 1746 QI | 170 | 167 ÷ 170 | 951,00 | 69,2 | • |
| LPS3 1846 QI | 180 | 177 ÷ 180 | 987,00 | 74,2 | • |

Parete fissa - Pezzi da ordinare
Side - Necessary pieces
Seite - Notwendige Stücke
Paroi fixe - Paroi à commander

| | | | | |
|---------------|-----|-----------|--------|---|
| LPF3 6516 QI | 65 | 62,5 ÷ 64 | 303,00 | 2 |
| LPF3 7016 QI | 70 | 67,5 ÷ 69 | 316,00 | 2 |
| LPF3 7516 QI | 75 | 72,5 ÷ 74 | 336,00 | 2 |
| LPF3 8016 QI | 80 | 77,5 ÷ 79 | 344,00 | 2 |
| LPF3 9016 QI | 90 | 87,5 ÷ 89 | 372,00 | 2 |
| LPF3 10016 QI | 100 | 97,5 ÷ 99 | 436,00 | 2 |

PROFILO MAGGIORE ESTENSIBILITÀ

Wall profile adjustment - Verlängerungsprofil - Profilé pour extension supplémentaire

| Codice - Code Artikel - Article | Formato (cm) - Size Format - Dimension | + cm. | Prezzo (€) - Price Preis - Prix |
|---|--|--------------|---|
| MTP 31 QI | 4,2 x 200 | 1,5 | 88,00 |

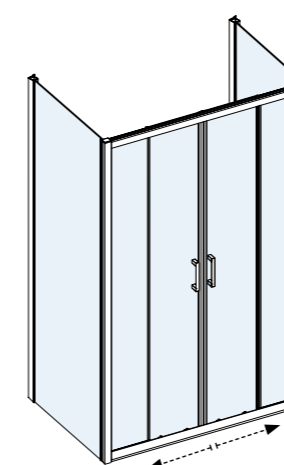

PROFILO A MURO WALL PROFILE - WANDPROFIL - PROFIL DE MUR

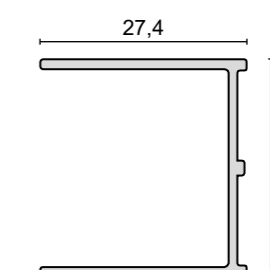

TRATTAMENTO ANTICALCARE

Descaling
Entkalkungsbehandlung
Traitement anticalcaire

STROMBOLI EVO MATT

CRISTALLO SATINATO
MATT CRYSTAL
SATINIERTES KRISTALLGLAS
VERRE MAT

| CODICE <i>Code - Artikel - Article</i> | Formato (cm) <i>Size - Format - Dimension</i> | Estensibilità <i>Extensibility - Streckbarkeit - Extensibilité</i> | Prezzo (€) <i>Price - Preis - Prix</i> | E <i>cm</i> | Lato porta <i>Door - Tür - Porte</i> |
|--|---|--|--|-----------------------|--|
| LPS3 1246M QI | 120 | 117 ÷ 130 | 942,00 | 44,2 | • |
| LPS3 1346M QI | 130 | 127 ÷ 130 | 946,00 | 49,2 | • |
| LPS3 1446M QI | 140 | 137 ÷ 140 | 989,00 | 54,2 | • |
| LPS3 1546M QI | 150 | 147 ÷ 150 | 1.006,00 | 59,2 | • |
| LPS3 1646M QI | 160 | 157 ÷ 160 | 1.035,00 | 64,2 | • |
| LPS3 1746M QI | 170 | 167 ÷ 170 | 1.064,00 | 69,2 | • |

6 mm
SCORREVOLI
SLIDING

PROFILO MAGGIORE ESTENSIBILITÀ

Wall profile adjustment - Verlängerungsprofil - Profilé pour extension supplémentaire

| Codice - Code <i>Artikel - Article</i> | Formato (cm) - Size <i>Format - Dimension</i> | + cm. | Prezzo (€) - Price <i>Preis - Prix</i> |
|--|---|--------------|--|
| MTP 31 QI | 4,2 x 200 | 1,5 | 88,00 |

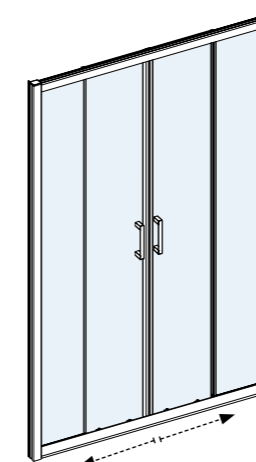

PROFILO A MURO WALL PROFILE - WANDPROFIL - PROFIL DE MUR

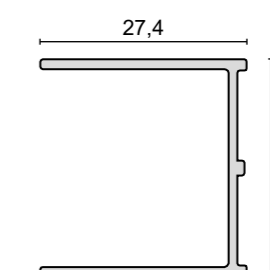

TRATTAMENTO ANTICALCARE

Descaling
Entkalkungsbehandlung
Traitement anticalcaire

STROMBOLI EVO MATT

CRISTALLO SATINATO
MATT CRYSTAL
SATINIERTES KRISTALLGLAS
VERRE MAT

| CODICE <i>Code - Artikel - Article</i> | Formato (cm) <i>Size - Format - Dimension</i> | Estensibilità <i>Extensibility - Streckbarkeit - Extensibilité</i> | Prezzo (€) <i>Price - Preis - Prix</i> | E cm | Lato porta <i>Door - Tür - Porte</i> |
|---|--|---|---|----------------|---|
| LPS3 1246M QI | 120 | 117 ÷ 120 | 942,00 | 44,2 | • |
| LPS3 1346M QI | 130 | 127 ÷ 130 | 946,00 | 49,2 | • |
| LPS3 1446M QI | 140 | 137 ÷ 140 | 989,00 | 54,2 | • |
| LPS3 1546M QI | 150 | 147 ÷ 150 | 1.006,00 | 59,2 | • |
| LPS3 1646M QI | 160 | 157 ÷ 160 | 1.035,00 | 64,2 | • |
| LPS3 1746M QI | 170 | 167 ÷ 170 | 1.064,00 | 69,2 | • |

Parete fissa - Pezzi da ordinare
Side - Necessary pieces
Seite - Notwendige Stücke
Paroi fixe - Paroi à commander

| | | | | |
|---------------|----|-----------|--------|---|
| LPF3 7016M QI | 70 | 67,5 ÷ 69 | 362,00 | 1 |
| LPF3 7516M QI | 75 | 72,5 ÷ 74 | 392,00 | 1 |
| LPF3 8016M QI | 80 | 77,5 ÷ 79 | 397,00 | 1 |
| LPF3 9016M QI | 90 | 87,5 ÷ 89 | 432,00 | 1 |

PROFILO MAGGIORE ESTENSIBILITÀ

Wall profile adjustment - Verlängerungsprofil - Profilé pour extension supplémentaire

| Codice - Code Artikel - Article | Formato (cm) - Size Format - Dimension | + cm. | Prezzo (€) - Price Preis - Prix |
|------------------------------------|---|-------|------------------------------------|
| MTP 31 QI | 4,2 x 200 | 1,5 | 88,00 |

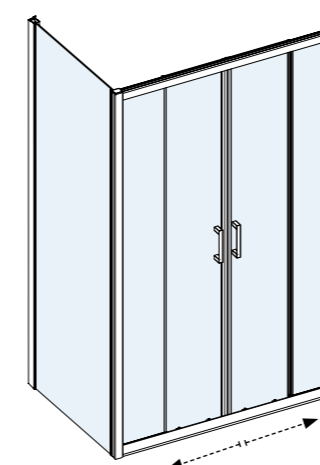

PROFILO A MURO WALL PROFILE - WANDPROFIL - PROFIL DE MUR

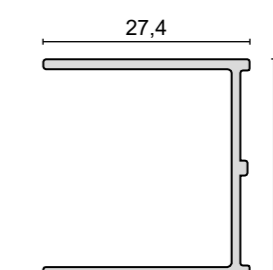

TRATTAMENTO ANTICALCARE

Descaling
Entkalkungsbehandlung
Traitement anticalcaire

STROMBOLI EVO MATT

CRISTALLO SATINATO
MATT CRYSTAL
SATINIERTES KRISTALLGLAS
VERRE MAT

| CODICE <i>Code - Artikel - Article</i> | Formato (cm) <i>Size - Format - Dimension</i> | Estensibilità <i>Extensibility - Streckbarkeit - Extensibilité</i> | Prezzo (€) <i>Price - Preis - Prix</i> | E <i>cm</i> | Lato porta <i>Door - Tür - Porte</i> |
|--|---|--|--|-----------------------|--|
| LPS3 1246M QI | 120 | 117 ÷ 120 | 942,00 | 44,2 | • |
| LPS3 1346M QI | 130 | 127 ÷ 130 | 946,00 | 49,2 | • |
| LPS3 1446M QI | 140 | 137 ÷ 140 | 989,00 | 54,2 | • |
| LPS3 1546M QI | 150 | 147 ÷ 150 | 1.006,00 | 59,2 | • |
| LPS3 1646M QI | 160 | 157 ÷ 160 | 1.035,00 | 64,2 | • |
| LPS3 1746M QI | 170 | 167 ÷ 170 | 1.064,00 | 69,2 | • |

Parete fissa - Pezzi da ordinare
Side - Necessary pieces
Seite - Notwendige Stücke
Paroi fixe - Paroi à commander

| | | | | |
|----------------------|----|-----------|--------|----------|
| LPF3 7016M QI | 70 | 67,5 ÷ 69 | 362,00 | 2 |
| LPF3 7516M QI | 75 | 72,5 ÷ 74 | 392,00 | 2 |
| LPF3 8016M QI | 80 | 77,5 ÷ 79 | 397,00 | 2 |
| LPF3 9016M QI | 90 | 87,5 ÷ 89 | 432,00 | 2 |

PROFILO MAGGIORE ESTENSIBILITÀ

Wall profile adjustment - Verlängerungsprofil - Profilé pour extension supplémentaire

| Codice - Code <i>Artikel - Article</i> | Formato (cm) - Size <i>Format - Dimension</i> | + cm. | Prezzo (€) - Price <i>Preis - Prix</i> |
|--|---|--------------|--|
| MTP 31 QI | 4,2 x 200 | 1,5 | 88,00 |

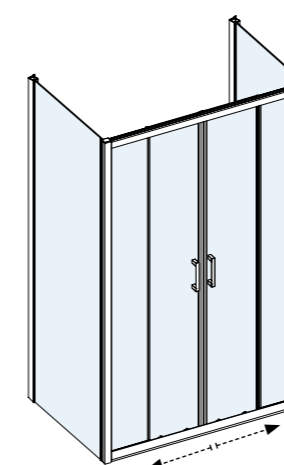

PROFILO A MURO WALL PROFILE - WANDPROFIL - PROFIL DE MUR

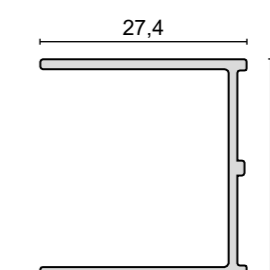

TRATTAMENTO ANTICALCARE

Descaling
Entkalkungsbehandlung
Traitement anticalcaire

PONZA EVO

CRISTALLO TRASPARENTE
TRANSPARENT CRYSTAL
TRANSPARENTES KRISTALLGLAS
VERRE TRANSPARENT

| CODICE Code - Artikel - Article | Formato (cm) Size - Format - Dimension | Estensibilità Extensibility - Streckbarkeit - Extensibilité | Prezzo (€) Price - Preis - Prix | E cm | Ingombro porta Door space Tür-Raumbedarf - Passage |
|---|--|---|---|----------------|---|
| LL3 7026 | 70 | 67 ÷ 70 | 726,00 | 46 | 31,0 |
| LL3 7526 | 75 | 72 ÷ 75 | 744,00 | 51 | 33,5 |
| LL3 8026 | 80 | 77 ÷ 80 | 759,00 | 56 | 36,0 |
| LL3 8526 | 85 | 82 ÷ 85 | 768,00 | 59 | 38,5 |
| LL3 9026 | 90 | 87 ÷ 90 | 780,00 | 64 | 41,0 |
| LL3 9526 | 95 | 92 ÷ 95 | 804,00 | 69 | 43,5 |
| LL3 10026 | 100 | 97 ÷ 100 | 807,00 | 74 | 46,0 |
| LL3 10526 | 105 | 102 ÷ 105 | 827,00 | 79 | 48,5 |
| LL3 11026 | 110 | 107 ÷ 110 | 840,00 | 84 | 51,0 |
| LL3 11526 | 115 | 112 ÷ 115 | 856,00 | 89 | 53,5 |
| LL3 12026 | 120 | 117 ÷ 120 | 866,00 | 94 | 56,0 |

6 mm
SCORREVOLI
SLIDING

PROFILO MAGGIORE ESTENSIBILITÀ

Wall profile adjustment - Verlängerungsprofil - Profilé pour extension supplémentaire

| Codice - Code Artikel - Article | Formato (cm) - Size Format - Dimension | + cm. | Prezzo (€) - Price Preis - Prix |
|---|--|--------------|---|
| MTP 31 QI | 4,2 x 200 | 1,5 | 88,00 |

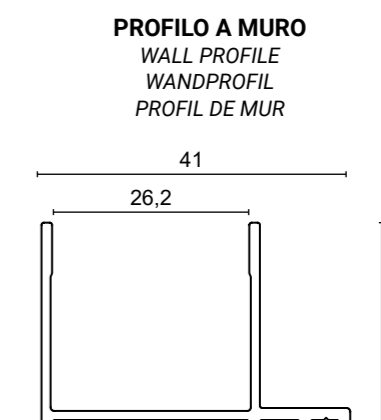
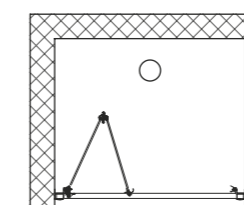
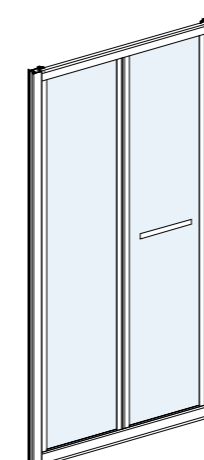
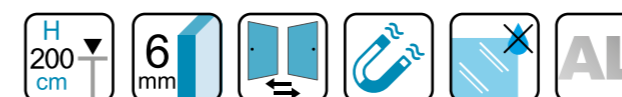

PROFILO A MURO
WALL PROFILE
WANDPROFIL
PROFIL DE MUR

TRATTAMENTO ANTICALCARE

Descaling
Entkalkungsbehandlung
Traitement anticalcaire

PONZA EVO

CRISTALLO TRASPARENTE
TRANSPARENT CRYSTAL
TRANSPARENTES KRISTALLGLAS
VERRE TRANSPARENT

| CODICE Code - Artikel - Article | Formato (cm) Size - Format - Dimension | Estensibilità Extensibility - Streckbarkeit - Extensibilité | Prezzo (€) Price - Preis - Prix | E cm | Ingombro porta Door space Tür-Raumbedarf - Passage |
|---|--|---|---|----------------|---|
| LL3 7026 | 70 | 67 ÷ 70 | 726,00 | 46 | 31,0 |
| LL3 7526 | 75 | 72 ÷ 75 | 744,00 | 51 | 33,5 |
| LL3 8026 | 80 | 77 ÷ 80 | 759,00 | 56 | 36,0 |
| LL3 8526 | 85 | 82 ÷ 85 | 768,00 | 59 | 38,5 |
| LL3 9026 | 90 | 87 ÷ 90 | 780,00 | 64 | 41,0 |
| LL3 9526 | 95 | 92 ÷ 95 | 804,00 | 69 | 43,5 |
| LL3 10026 | 100 | 97 ÷ 100 | 807,00 | 74 | 46,0 |
| LL3 10526 | 105 | 102 ÷ 105 | 827,00 | 79 | 48,5 |
| LL3 11026 | 110 | 107 ÷ 110 | 840,00 | 84 | 51,0 |
| LL3 11526 | 115 | 112 ÷ 115 | 856,00 | 89 | 53,5 |
| LL3 12026 | 120 | 117 ÷ 120 | 866,00 | 94 | 56,0 |

Parete fissa - Pezzi da ordinare
Side - Necessary pieces
Seite - Notwendige Stücke
Paroi fixe - Paroi à commander

| | | | | |
|---------------|-----|-----------|--------|---|
| LPF3 6516 QI | 65 | 62,5 ÷ 64 | 303,00 | 1 |
| LPF3 7016 QI | 70 | 67,5 ÷ 69 | 316,00 | 1 |
| LPF3 7516 QI | 75 | 72,5 ÷ 74 | 336,00 | 1 |
| LPF3 8016 QI | 80 | 77,5 ÷ 79 | 344,00 | 1 |
| LPF3 9016 QI | 90 | 87,5 ÷ 89 | 372,00 | 1 |
| LPF3 10016 QI | 100 | 97,5 ÷ 99 | 436,00 | 1 |

PROFILO MAGGIORE ESTENSIBILITÀ

Wall profile adjustment - Verlängerungsprofil - Profilé pour extension supplémentaire

| Codice - Code Artikel - Article | Formato (cm) - Size Format - Dimension | + cm. | Prezzo (€) - Price Preis - Prix |
|---|--|--------------|---|
| MTP 31 QI | 4,2 x 200 | 1,5 | 88,00 |

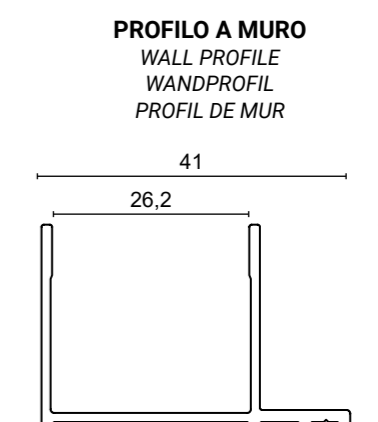
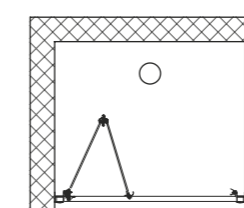
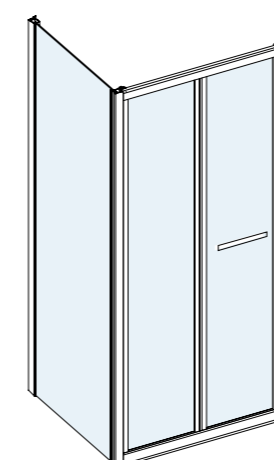
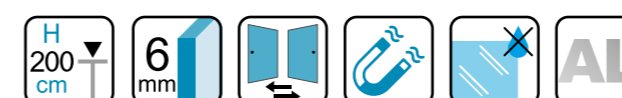

TRATTAMENTO ANTICALCARE

Descaling
Entkalkungsbehandlung
Traitement anticalcaire

PONZA EVO

CRISTALLO TRASPARENTE
TRANSPARENT CRYSTAL
TRANSPARENTES KRISTALLGLAS
VERRE TRANSPARENT

| CODICE Code - Artikel - Article | Formato (cm) Size - Format - Dimension | Estensibilità Extensibility - Streckbarkeit - Extensibilité | Prezzo (€) Price - Preis - Prix | E cm | Ingombro porta Door space Tür-Raumbedarf - Passage |
|---|--|---|---|----------------|---|
| LL3 7026 | 70 | 67 ÷ 70 | 726,00 | 46 | 31,0 |
| LL3 7526 | 75 | 72 ÷ 75 | 744,00 | 51 | 33,5 |
| LL3 8026 | 80 | 77 ÷ 80 | 759,00 | 56 | 36,0 |
| LL3 8526 | 85 | 82 ÷ 85 | 768,00 | 59 | 38,5 |
| LL3 9026 | 90 | 87 ÷ 90 | 780,00 | 64 | 41,0 |
| LL3 9526 | 95 | 92 ÷ 95 | 804,00 | 69 | 43,5 |
| LL3 10026 | 100 | 97 ÷ 100 | 807,00 | 74 | 46,0 |
| LL3 10526 | 105 | 102 ÷ 105 | 827,00 | 79 | 48,5 |
| LL3 11026 | 110 | 107 ÷ 110 | 840,00 | 84 | 51,0 |
| LL3 11526 | 115 | 112 ÷ 115 | 856,00 | 89 | 53,5 |
| LL3 12026 | 120 | 117 ÷ 120 | 866,00 | 94 | 56,0 |

Parete fissa - Pezzi da ordinare
Side - Necessary pieces
Seite - Notwendige Stücke
Paroi fixe - Paroi à commander

| | | | | |
|---------------|-----|-----------|--------|---|
| LPF3 6516 QI | 65 | 62,5 ÷ 64 | 303,00 | 2 |
| LPF3 7016 QI | 70 | 67,5 ÷ 69 | 316,00 | 2 |
| LPF3 7516 QI | 75 | 72,5 ÷ 74 | 336,00 | 2 |
| LPF3 8016 QI | 80 | 77,5 ÷ 79 | 344,00 | 2 |
| LPF3 9016 QI | 90 | 87,5 ÷ 89 | 372,00 | 2 |
| LPF3 10016 QI | 100 | 97,5 ÷ 99 | 436,00 | 2 |

PROFILO MAGGIORE ESTENSIBILITÀ

Wall profile adjustment - Verlängerungsprofil - Profilé pour extension supplémentaire

| Codice - Code Artikel - Article | Formato (cm) - Size Format - Dimension | + cm. | Prezzo (€) - Price Preis - Prix |
|---|--|--------------|---|
| MTP 31 QI | 4,2 x 200 | 1,5 | 88,00 |

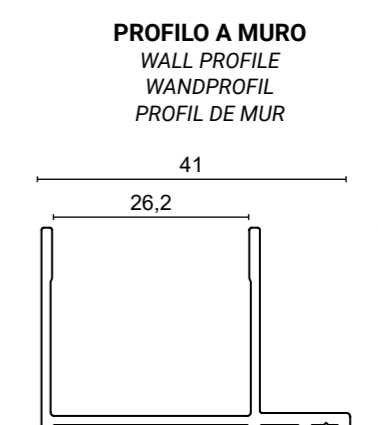
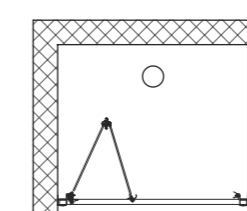
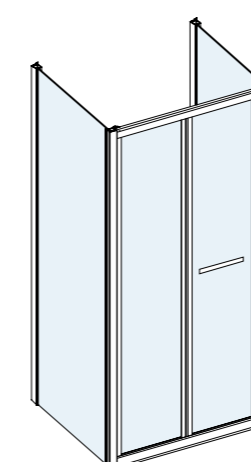
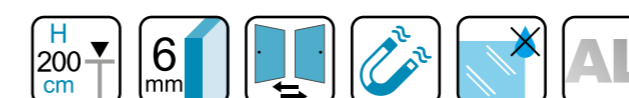

PROFILO A MURO
WALL PROFILE
WANDPROFIL
PROFIL DE MUR

TRATTAMENTO ANTICALCARE

Descaling
Entkalkungsbehandlung
Traitement anticalcaire

PONZA EVO MATT

CRISTALLO SATINATO
MATT CRYSTAL
SATINIERTES KRISTALLGLAS
VERRE MAT

| CODICE <i>Code - Artikel - Article</i> | Formato (cm) <i>Size - Format - Dimension</i> | Estensibilità <i>Extensibility Streckbarkeit - Extensibilité</i> | Prezzo (€) <i>Price - Preis - Prix</i> |  6 cm | Ingombro porta <i>Door space Tür-Raumbedarf - Passage</i> | Lato porta <i>Door Tür - Porte</i> |
|---|--|---|---|--|--|---|
| LL3 7526M | 75 | 72 ÷ 75 | 780,00 | 51 | 33,5 | • |
| LL3 8026M | 80 | 77 ÷ 80 | 792,00 | 56 | 36,0 | • |
| LL3 8526M | 85 | 82 ÷ 85 | 804,00 | 59 | 38,5 | • |
| LL3 9026M | 90 | 87 ÷ 90 | 818,00 | 64 | 41,0 | • |
| LL3 9526M | 95 | 92 ÷ 95 | 852,00 | 69 | 43,5 | • |
| LL3 10026M | 100 | 97 ÷ 100 | 858,00 | 74 | 46,0 | • |
| LL3 10526M | 105 | 102 ÷ 105 | 890,00 | 79 | 48,5 | • |
| LL3 11026M | 110 | 107 ÷ 110 | 908,00 | 84 | 51,0 | • |
| LL3 12026M | 120 | 117 ÷ 120 | 946,00 | 94 | 56,0 | • |

6 mm
SCORREVOLI
SLIDING

PROFILO MAGGIORE ESTENSIBILITÀ

Wall profile adjustment - Verlängerungsprofil - Profilé pour extension supplémentaire

| Codice - Code Artikel - Article | Formato (cm) - Size Format - Dimension | + cm. | Prezzo (€) - Price Preis - Prix |
|------------------------------------|---|-------|------------------------------------|
| MTP 31 QI | 4,2 x 200 | 1,5 | 88,00 |

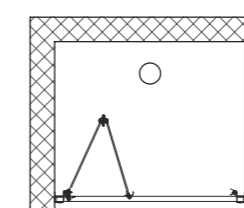
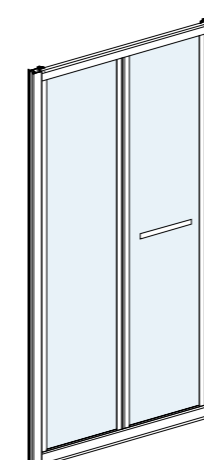
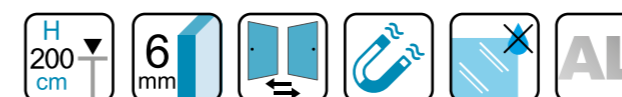

PROFILO A MURO
WALL PROFILE
WANDPROFIL
PROFIL DE MUR

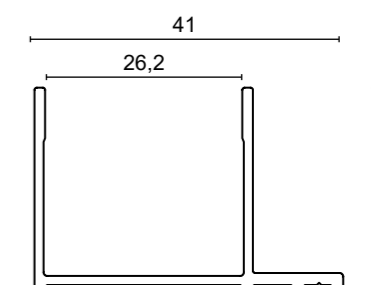

TRATTAMENTO ANTICALCARE

Descaling
Entkalkungsbehandlung
Traitement anticalcaire

PONZA EVO MATT

CRISTALLO SATINATO
MATT CRYSTAL
SATINIERTES KRISTALLGLAS
VERRE MAT

| CODICE Code - Artikel - Article | Formato (cm) Size - Format - Dimension | Estensibilità Extensibility Streckbarkeit - Extensibilité | Prezzo (€) Price - Preis - Prix | E cm | Ingombro porta Door space Tür-Raumbedarf - Passage | Lato porta Door Tür - Porte |
|---|--|--|---|----------------|---|--|
| LL3 7526M | 75 | 72 ÷ 75 | 780,00 | 51 | 33,5 | • |
| LL3 8026M | 80 | 77 ÷ 80 | 792,00 | 56 | 36,0 | • |
| LL3 8526M | 85 | 82 ÷ 85 | 804,00 | 59 | 38,5 | • |
| LL3 9026M | 90 | 87 ÷ 90 | 818,00 | 64 | 41,0 | • |
| LL3 9526M | 95 | 92 ÷ 95 | 852,00 | 69 | 43,5 | • |
| LL3 10026M | 100 | 97 ÷ 100 | 858,00 | 74 | 46,0 | • |
| LL3 10526M | 105 | 102 ÷ 105 | 890,00 | 79 | 48,5 | • |
| LL3 11026M | 110 | 107 ÷ 110 | 908,00 | 84 | 51,0 | • |
| LL3 12026M | 120 | 117 ÷ 120 | 946,00 | 94 | 56,0 | • |

Parete fissa - Pezzi da ordinare
Side - Necessary pieces
Seite - Notwendige Stücke
Paroi fixe - Paroi à commander

| | | | | |
|---------------|----|-----------|--------|---|
| LPF3 7016M QI | 70 | 67,5 ÷ 69 | 362,00 | 1 |
| LPF3 7516M QI | 75 | 72,5 ÷ 74 | 392,00 | 1 |
| LPF3 8016M QI | 80 | 77,5 ÷ 79 | 397,00 | 1 |
| LPF3 9016M QI | 90 | 87,5 ÷ 89 | 432,00 | 1 |

PROFILO MAGGIORE ESTENSIBILITÀ

Wall profile adjustment - Verlängerungsprofil - Profilé pour extension supplémentaire

| Codice - Code Artikel - Article | Formato (cm) - Size Format - Dimension | + cm. | Prezzo (€) - Price Preis - Prix |
|---|--|--------------|---|
| MTP 31 QI | 4,2 x 200 | 1,5 | 88,00 |

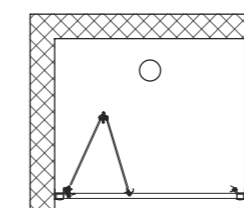
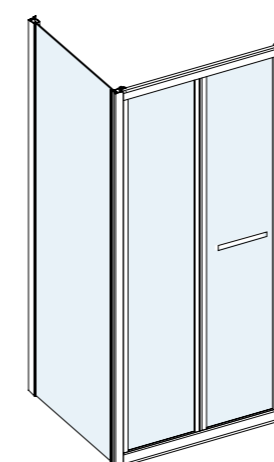
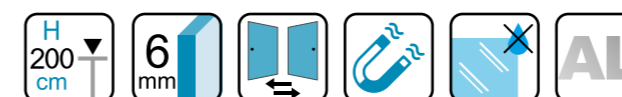

PROFILO A MURO
WALL PROFILE
WANDPROFIL
PROFIL DE MUR

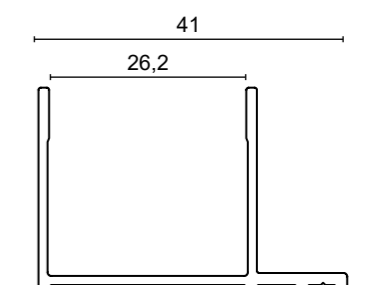

TRATTAMENTO ANTICALCARE

Descaling
Entkalkungsbehandlung
Traitement anticalcaire

PONZA EVO MATT

CRISTALLO SATINATO
MATT CRYSTAL
SATINIERTES KRISTALLGLAS
VERRE MAT

| CODICE Code - Artikel - Article | Formato (cm) Size - Format - Dimension | Estensibilità Extensibility Streckbarkeit - Extensibilität | Prezzo (€) Price - Preis - Prix | E cm | Ingombro porta Door space Tür-Raumbedarf - Passage | Lato porta Door Tür - Porte |
|---|--|---|---|----------------|---|--|
| LL3 7526M | 75 | 72 ÷ 75 | 780,00 | 51 | 33,5 | • |
| LL3 8026M | 80 | 77 ÷ 80 | 792,00 | 56 | 36,0 | • |
| LL3 8526M | 85 | 82 ÷ 85 | 804,00 | 59 | 38,5 | • |
| LL3 9026M | 90 | 87 ÷ 90 | 818,00 | 64 | 41,0 | • |
| LL3 9526M | 95 | 92 ÷ 95 | 852,00 | 69 | 43,5 | • |
| LL3 10026M | 100 | 97 ÷ 100 | 858,00 | 74 | 46,0 | • |
| LL3 10526M | 105 | 102 ÷ 105 | 890,00 | 79 | 48,5 | • |
| LL3 11026M | 110 | 107 ÷ 110 | 908,00 | 84 | 51,0 | • |
| LL3 12026M | 120 | 117 ÷ 120 | 946,00 | 94 | 56,0 | • |

Parete fissa - Pezzi da ordinare
Side - Necessary pieces
Seite - Notwendige Stücke
Paroi fixe - Paroi à commander

| | | | | |
|---------------|----|-----------|--------|---|
| LPF3 7016M QI | 70 | 67,5 ÷ 69 | 362,00 | 2 |
| LPF3 7516M QI | 75 | 72,5 ÷ 74 | 392,00 | 2 |
| LPF3 8016M QI | 80 | 77,5 ÷ 79 | 397,00 | 2 |
| LPF3 9016M QI | 90 | 87,5 ÷ 89 | 432,00 | 2 |

PROFILO MAGGIORE ESTENSIBILITÀ

Wall profile adjustment - Verlängerungsprofil - Profilé pour extension supplémentaire

| Codice - Code Artikel - Article | Formato (cm) - Size Format - Dimension | + cm. | Prezzo (€) - Price Preis - Prix |
|---|--|--------------|---|
| MTP 31 QI | 4,2 x 200 | 1,5 | 88,00 |

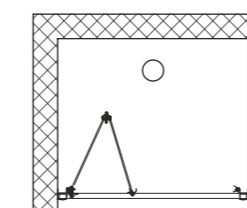
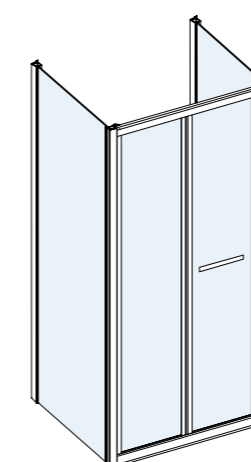
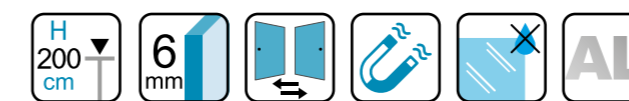

PROFILO A MURO
WALL PROFILE
WANDPROFIL
PROFIL DE MUR

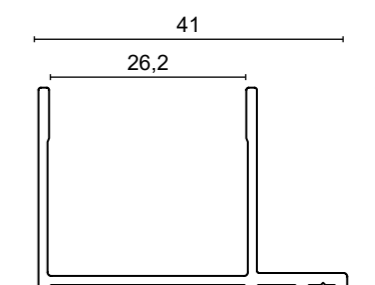

TRATTAMENTO
ANTICALCARE

Descaling
Entkalkungsbehandlung
Traitement anticalcaire

VULCANO EVO / BLACK

CRISTALLO TRASPARENTE
TRANSPARENT CRYSTAL
TRANSPARENTES KRISTALLGLAS
VERRE TRANSPARENT

| CODICE <i>Code - Artikel - Article</i> | Formato (cm) <i>Size - Format - Dimension</i> | Estensibilità <i>Extensibility - Streckbarkeit - Extensibilité</i> | Prezzo (€) <i>Price - Preis - Prix</i> |
|---|--|---|---|
| LPF3 6516 QI | 65 | 62,5 ÷ 64 | 303,00 |
| LPF3 7016 QI | 70 | 67,5 ÷ 69 | 316,00 |
| LPF3 7516 QI | 75 | 72,5 ÷ 74 | 336,00 |
| LPF3 8016 QI | 80 | 77,5 ÷ 79 | 344,00 |
| LPF3 9016 QI | 90 | 87,5 ÷ 89 | 372,00 |
| LPF3 10016 QI | 100 | 97,5 ÷ 99 | 436,00 |
| | | | |
| LPF3 7016BT QI | 70 | 67,5 ÷ 69 | 391,00 |
| LPF3 7516BT QI | 75 | 72,5 ÷ 74 | 407,00 |
| LPF3 8016BT QI | 80 | 77,5 ÷ 79 | 424,00 |
| LPF3 9016BT QI | 90 | 87,5 ÷ 89 | 459,00 |

PROFILO MAGGIORE ESTENSIBILITÀ

Wall profile adjustment - Verlängerungsprofil - Profilé pour extension supplémentaire

| Codice - Code Artikel - Article | Formato (cm) - Size Format - Dimension | + cm. | Prezzo (€) - Price Preis - Prix |
|------------------------------------|---|-------|------------------------------------|
| MTP 31 QI | 4,2 x 200 | 1,5 | 88,00 |

PROFILO MAGGIORE ESTENSIBILITÀ

Wall profile adjustment - Verlängerungsprofil - Profilé pour extension supplémentaire

| Codice - Code Artikel - Article | Formato (cm) - Size Format - Dimension | + cm. | Prezzo (€) - Price Preis - Prix |
|------------------------------------|---|-------|------------------------------------|
| MTP 31B QI | 4,2 x 200 | 1,5 | 88,00 |

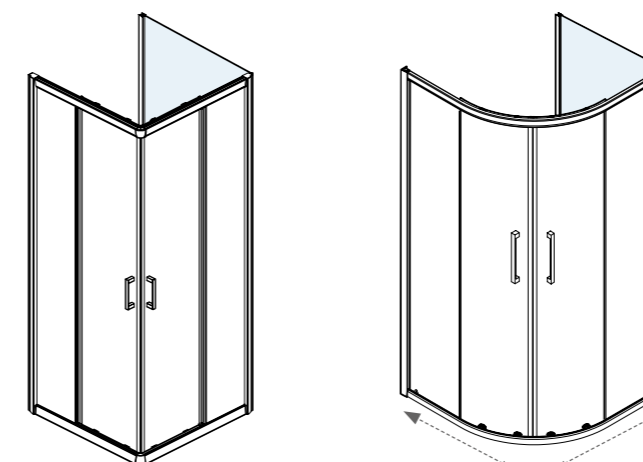
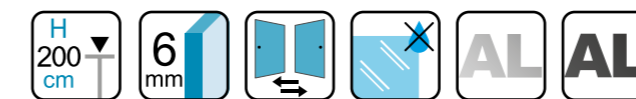

PROFILO A MURO WALL PROFILE - WANDPROFIL - PROFIL DE MUR

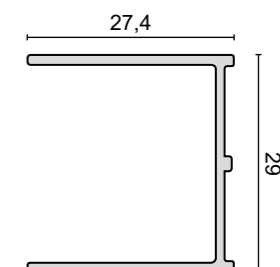

TRATTAMENTO
ANTICALCARE

Descaling
Entkalkungsbehandlung
Traitement anticalcaire

VULCANO EVO MATT / FOX

CRISTALLO SATINATO / PIUMATO
MATT CRYSTAL - FOX CRYSTAL
SATINIERTES KRISTALLGLAS - FOX KRISTALLGLAS
VERRE MAT - VERRE GRANITÉ

| CODICE <i>Code - Artikel - Article</i> | Formato (cm) <i>Size - Format - Dimension</i> | Estensibilità <i>Extensibility - Streckbarkeit - Extensibilité</i> | Prezzo (€) <i>Price - Preis - Prix</i> |
|---|--|---|---|
| LPF3 7016M QI | 70 | 67,5 ÷ 69 | 362,00 |
| LPF3 7516M QI | 75 | 72,5 ÷ 74 | 392,00 |
| LPF3 8016M QI | 80 | 77,5 ÷ 79 | 397,00 |
| LPF3 9016M QI | 90 | 87,5 ÷ 89 | 432,00 |
| LPF3 7016F QI | 70 | 67,5 ÷ 69 | 362,00 |
| LPF3 7516F QI | 75 | 72,5 ÷ 74 | 392,00 |
| LPF3 8016F QI | 80 | 77,5 ÷ 79 | 397,00 |
| LPF3 9016F QI | 90 | 87,5 ÷ 89 | 432,00 |



Cristallo piumato - Fox crystal
Fox Kristallglas - Verre granité

PROFILO MAGGIORE ESTENSIBILITÀ

Wall profile adjustment - Verlängerungsprofil - Profilé pour extension supplémentaire

| Codice - Code Artikel - Article | Formato (cm) - Size Format - Dimension | + cm. | Prezzo (€) - Price Preis - Prix |
|------------------------------------|---|------------|------------------------------------|
| MTP 31 QI | 4,2 x 200 | 1,5 | 88,00 |

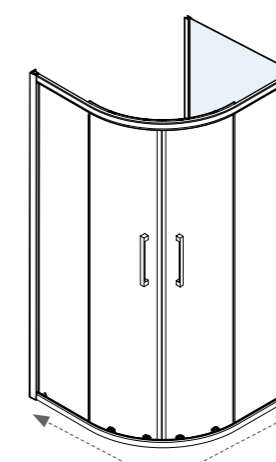
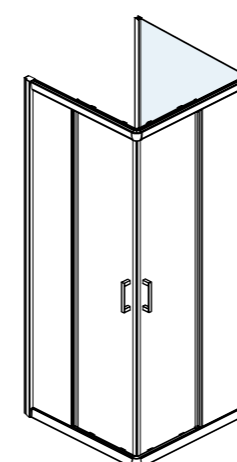

PROFILO A MURO WALL PROFILE - WANDPROFIL - PROFIL DE MUR

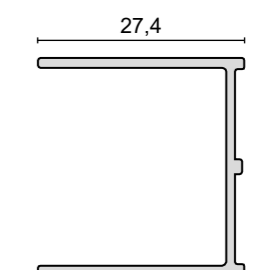

LIPARI / STROMBOLI / PONZA EVO / VULCANO EVO

LACUS RIVESTE... SU MISURA - LACUS MAKES IT... TO MEASURE - LACUS FERTIG ...MASSGERECHT - LACUS UNE FABRICATION SUR ...MESURE

Articoli speciali su ordinazione - Special Items on request - Sonderanfertigungen auf Bestellung - Articles 'à la carte' sur commande

| LATO FISSO - FIXED PANEL FESTE SEITENWAND - PANNEAU FIXE | LATO PORTA DOOR - TÜR - PORTE | VETRO SOPRA MURETTO - GLASS ON THE WALL GLAS AN DER WAND - PAROI SUR MURET |
|---|--|---|
| Altezza max 200 cm. - Larghezza max 150 cm. Height max 200 cm. - Width max 150 cm. Maximale Höhe 200 cm. - Maximale Breite 150 cm. Hauteur 200 cm. maximum - Largeur 150 cm. maximum | Altezza N.D. - Larghezza max 180 cm. Height N.A. - Width max cm. 180 Höhe N.V. - Maximale Breite 180 cm. Hauteur N.D. - Largeur 180 cm. maximum | |
| | Altezza N.D. - Larghezza max 140 cm. Height N.A. - Width max cm. 140 Höhe N.V. - Maximale Breite 140 cm. Hauteur N.D. - Largeur 140 cm. maximum | |

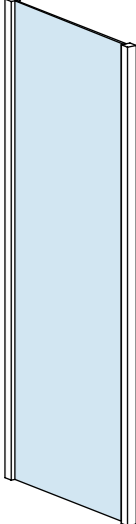
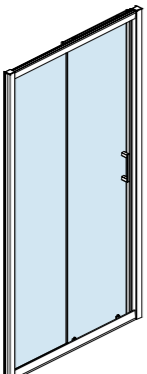
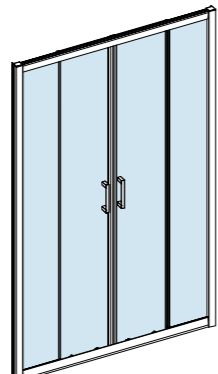
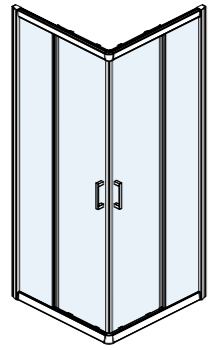
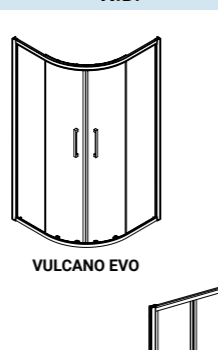

| PREZZO DI LISTINO AL PEZZO (TRASPARENTE) GROSS PREIS PRO PIECE (TRANSPARENT) LISTENPREIS PRO STÜCK (TRANSPARENT) PRIX TARIF PAR PIÈCE (TRANSPARENT) | PREVENTIVO SU RICHIESTA PRICE ON REQUEST ANGEBOT AUF ANFRAGE DEVIS SUR DEMANDE | PREVENTIVO SU RICHIESTA PRICE ON REQUEST ANGEBOT AUF ANFRAGE DEVIS SUR DEMANDE |
|---|--|---|
|  <p>FASCIA 1: da 0,01 a 0,50 mq Level 1: from 0.01 to 0.5 sqm</p> <p>€ 450,00</p> |  <p>LIPARI</p> | |
| <p>FASCIA 2: da 0,51 a 1,00 mq Level 2: from 0.51 to 1.0 sqm</p> <p>€ 530,00</p> |  <p>STROMBOLI</p> | |
| <p>FASCIA 3: da 1,01 a 1,50 mq Level 3: from 1.01 to 1.5 sqm</p> <p>€ 627,00</p> | | |
| <p>FASCIA 4: da 1,51 a 2,00 mq Level 4: from 1.51 to 2.0 sqm</p> <p>€ 710,00</p> |  <p>VULCANO EVO</p> | |
| <p>FASCIA 5: da 2,01 a 2,50 mq Level 5: from 2.01 to 2.5 sqm</p> <p>€ 793,00</p> | <p>N.D.</p>  <p>PONZA EVO</p> | |
| <p>FASCIA 6: da 2,51 a 3,00 mq Level 6: from 2.51 to 3.0 sqm</p> <p>€ 900,00</p> | | |
| <p>Maggiorazione per vetro Matt, Fox e Gray: +15% Surcharge for matt, fox and grey crystal + 15% Aufpreis für Matt, Fox und Grey Kristallglas +15% Majoration pour les verres Matt, Fox et Grey: +15%</p> | | |

ATTENZIONE:

CALCOLARE I MQ. DEL PEZZO PER STABILIRE LA FASCIA DI APPARTENENZA

Per soluzioni diverse da quelle contemplate contattare ns. ufficio tecnico per avere indicazioni di fattibilità e prezzi.

VORSICHT:

BERECHNEN DIE QM. DES STÜCKES, ZUR ERFÜLLUNG DER ZUGEHÖRIGEN BAND
Für andere als die in Betracht gezogenen Lösungen wenden Sie sich an unser technisches Büro, um Informationen zu Machbarkeit und Preisen zu erhalten.

ATTENTION:

CALCULATE THE SQM OF THE ARTIKEL TO ESTABLISH THE BELONGING LEVEL.

For information on feasibility and prices of other solutions, please get in touch with our technical dept.

ATTENTION:

CALCULER LES M². DE LA PAROI POUR ÉTABLIR LA TRANCHE D'APPARTENANCE
Pour d'autres solutions que celles envisagées, contactez notre bureau technique pour connaître la faisabilité et les tarifs.

DETTAGLI & CARATTERISTICHE



PONZA EVO
CARRUCOLE - ROLLERS
RIEMENSCHLEIBE - ROULETTE

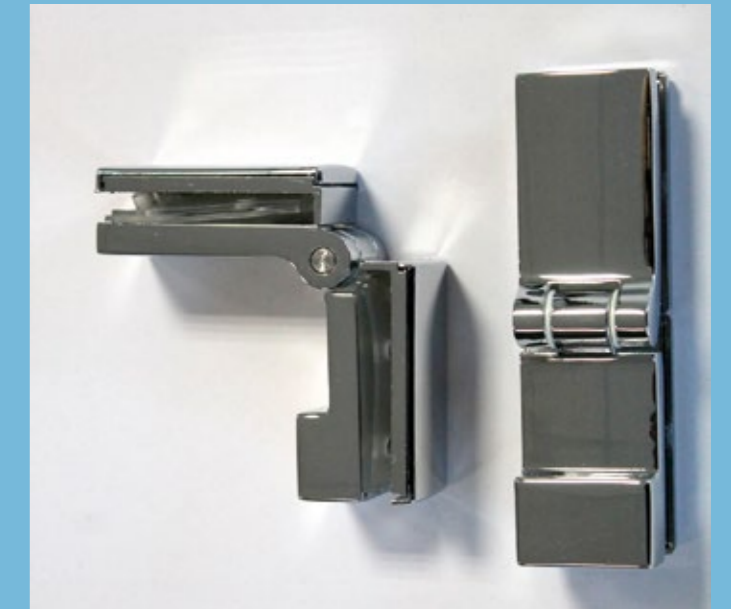

PONZA EVO
CERNIERE - HINGES - SCHARNIERE - CHARNIÈRE



VULCANO EVO / LIPARI EVO / STROMBOLI EVO
MANIGLIA - Handle - Griff - Poignée



VULCANO EVO
CORNER - Corner - Eckprofil - Profilé d'angle

CARATTERISTICHE GENERALI

- Cristallo temperato da 6 mm.
- Finitura trasparente, satinato, piumato.
- Profilo in alluminio cromo o laccato nero satinato.
- Chiusura magnetica delle ante.
- Doppia Clips a sgancio per la pulizia dei cristalli.
- Estensione da 1,5 cm.
- Maniglia in zama.

GENERAL CHARACTERISTICS

- Tempered crystal 6 mm.
- Transparent - matt - fox.
- Chrome aluminum, black satin profile.
- Magnetic waterproof clousure.
- Double opening clips for easy cleaning.
- Wall profile adjustment 1,5 cm.
- Handles made of zinc alloy.

TECHNISCHE MERKMALE

- Sekurirkristallglas 6 mm stark.
- Kristallglasfinish: Transparent, matt, fox.
- Poliertes Chrom- und schwarz-satiniertes Profil.
- Magnetverschluss.
- Lösbare Tür zur Kristallreinigung.
- Streckbarkeit 1,5 cm.
- Griff aus Zamak.

SPECIFICATIONS GENERALES

- Verre trempé de 6 mm.
- Finition du verre: transparent, mat, granité.
- Profilé en aluminium chromé, noir satiné.
- Portes à fermeture magnétique.
- Portes déclipantes dans la partie basse pour le nettoyage du verre.
- Extensibilité de 1,5 cm.
- Poignées en zamak.

PANAREA EVO

CRISTALLO TRASPARENTE
TRANSPARENT CRYSTAL
TRANSPARENTES KRISTALLGLAS
VERRE TRANSPARENT

| CODICE <i>Code - Artikel - Article</i> | Formato (cm) <i>Size - Format - Dimension</i> | Estensibilità <i>Extensibility Streckbarkeit - Extensibilité</i> | Prezzo (€) <i>Price - Preis - Prix</i> | E <i>cm</i> | Singolo lato <i>Single side Einzel Seite - Seul côté</i> |
|---|--|---|---|-----------------------|---|
| LA6 EVO 70 | 70 | 67 ÷ 69 | 314,00 | 19,0 | • |
| LA6 EVO 75 | 75 | 72 ÷ 74 | 347,00 | 20,8 | • |
| LA6 EVO 80 | 80 | 77 ÷ 79 | 329,00 | 22,5 | • |
| LA6 EVO 90 | 90 | 87 ÷ 89 | 346,00 | 26,0 | • |
| LA6 EVO 100 | 100 | 97 ÷ 99 | 377,00 | 29,5 | • |
| LA6 EVO 110 | 110 | 107 ÷ 109 | 449,00 | 33,0 | • |
| LA6 EVO 120 | 120 | 117 ÷ 119 | 420,00 | 36,5 | • |
| LA6 EVO 130 | 130 | 127 ÷ 129 | 502,00 | 39,5 | • |
| LA6 EVO 140 | 140 | 137 ÷ 139 | 504,00 | 42,5 | • |

*E: Spazio utile entrata - Entrance - Eingang - Entrée
 ↳ Sommare i valori dei singoli lati - Sum the value of each side
 Den Wert der einzelnen Seite addieren - Additionner la valeur de chaque côté

*Prezzo: ATTENZIONE il prezzo è relativo ad un singolo lato.
 *Price: NOTICE: Price is for 1 side only.
 *Preis: VORSICHT: Der Preis ist für eine einzelne Seite.
 *Prix: ATTENTION: le prix est pour un seul côté.

Possibilità di formare 3° lato con modello LPF6 EVO (pag. 381).
 The 3rd side can be made with the LPF6 EVO model (page 381).
 Möglichkeit die 3. Seitenwand mit LPF EVO-Modell (S. 381) einzubauen.
 Possibilité de réaliser le 3e côté avec le modèle LPF6 EVO (page 381).

PROFILO MAGGIORE ESTENSIBILITÀ

Wall profile adjustment - Verlängerungsprofil - Profilé pour extension supplémentaire

| Codice - Code Artikel - Article | Formato (cm) - Size Format - Dimension | + cm. | Prezzo (€) - Price Preis - Prix |
|------------------------------------|---|-------|------------------------------------|
| MTP 16E | 6,2 x 195 | 2,0 | 99,00 |

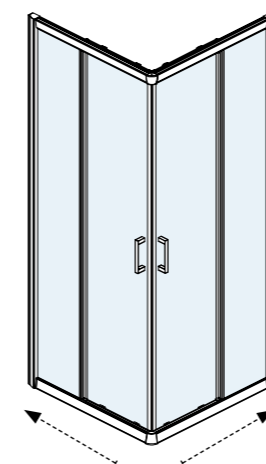
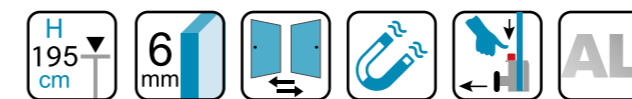

PROFILO A MURO WALL PROFILE - WANDPROFIL - PROFIL DE MUR

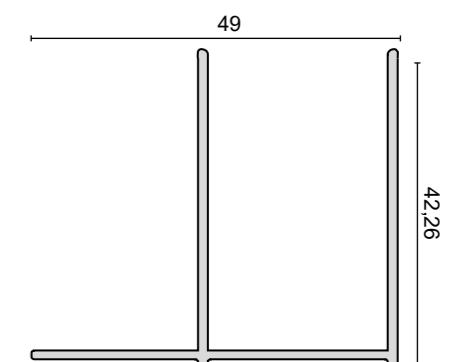

PANAREA EVO MATT

CRISTALLO SATINATO
MATT CRYSTAL
SATINIERTES KRISTALLGLAS
VERRE MAT

| CODICE <i>Code - Artikel - Article</i> | Formato (cm) <i>Size - Format - Dimension</i> | Estensibilità <i>Extensibility Streckbarkeit - Extensibilité</i> | Prezzo (€) <i>Price - Preis - Prix</i> | E <i>cm</i> | Singolo lato <i>Single side Einzel Seite - Seul côté</i> |
|---|--|---|---|-----------------------|---|
| LA6 EVO 70M | 70 | 67 ÷ 69 | 348,00 | 19,0 | • |
| LA6 EVO 75M | 75 | 72 ÷ 74 | 373,00 | 20,8 | • |
| LA6 EVO 80M | 80 | 77 ÷ 79 | 359,00 | 22,5 | • |
| LA6 EVO 90M | 90 | 87 ÷ 89 | 370,00 | 26,0 | • |
| LA6 EVO 100M | 100 | 97 ÷ 99 | 413,00 | 29,5 | • |
| LA6 EVO 110M | 110 | 107 ÷ 109 | 478,00 | 33,0 | • |
| LA6 EVO 120M | 120 | 117 ÷ 119 | 462,00 | 36,5 | • |
| LA6 EVO 130M | 130 | 127 ÷ 129 | 532,00 | 39,5 | • |
| LA6 EVO 140M | 140 | 137 ÷ 139 | 534,00 | 42,5 | • |

*E: Spazio utile entrata - Entrance - Eingang - Entrée

↳ Sommare i valori dei singoli lati - Sum the value of each side

Den Wert der einzelnen Seite addieren - Additionner la valeur de chaque côté

*Prezzo: ATTENZIONE il prezzo è relativo ad un singolo lato.

*Price: NOTICE: Price is for 1 side only.

*Preis: VORSICHT: Der Preis ist für eine einzelne Seite.

*Prix: ATTENTION: le prix est pour un seul côté.

Possibilità di formare 3° lato con modello LPF6 EVOM (pag. 383).

The 3rd side can be made with the LPF6 EVOM model (page 383).

Möglichkeit die 3. Seitenwand mit LPF6 EVOM-Modell (S. 383) einzubauen.

Possibilité de réaliser le 3e côté avec le modèle LPF6 EVOM (page 383).

PROFILO MAGGIORE ESTENSIBILITÀ

Wall profile adjustment - Verlängerungsprofil - Profilé pour extension supplémentaire

| Codice - Code Artikel - Article | Formato (cm) - Size Format - Dimension | + cm. | Prezzo (€) - Price Preis - Prix |
|------------------------------------|---|-------|------------------------------------|
| MTP 16E | 6,2 x 195 | 2,0 | 99,00 |

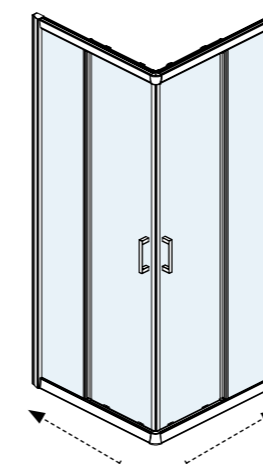
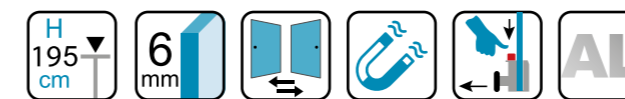

PROFILO A MURO WALL PROFILE - WANDPROFIL - PROFIL DE MUR

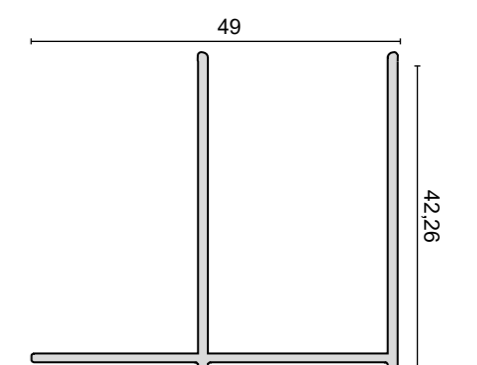

PANAREA EVO FOX

CRISTALLO PIUMATO
FOX CRYSTAL
FOX KRISTALLGLAS
VERRE GRANITÉ

| CODICE <i>Code - Artikel - Article</i> | Formato (cm) <i>Size - Format - Dimension</i> | Estensibilità <i>Extensibility Streckbarkeit - Extensibilité</i> | Prezzo (€) <i>Price - Preis - Prix</i> | E <i>cm</i> | Singolo lato <i>Single side Einzel Seite - Seul côté</i> |
|---|--|---|---|-----------------------|---|
| LA6 EVO 70F | 70 | 67 ÷ 69 | 348,00 | 19,0 | • |
| LA6 EVO 75F | 75 | 72 ÷ 74 | 373,00 | 20,8 | • |
| LA6 EVO 80F | 80 | 77 ÷ 79 | 359,00 | 22,5 | • |
| LA6 EVO 90F | 90 | 87 ÷ 89 | 370,00 | 26,0 | • |
| LA6 EVO 100F | 100 | 97 ÷ 99 | 413,00 | 29,5 | • |
| LA6 EVO 110F | 110 | 107 ÷ 109 | 478,00 | 33,0 | • |
| LA6 EVO 120F | 120 | 117 ÷ 119 | 462,00 | 36,5 | • |
| LA6 EVO 130F | 130 | 127 ÷ 129 | 532,00 | 39,5 | • |
| LA6 EVO 140F | 140 | 137 ÷ 139 | 534,00 | 42,5 | • |

*E: Spazio utile entrata - Entrance - Eingang - Entrée

↳ Sommare i valori dei singoli lati - Sum the value of each side

Den Wert der einzelnen Seite addieren - Additionner la valeur de chaque côté

*Prezzo: ATTENZIONE il prezzo è relativo ad un singolo lato.

*Price: NOTICE: Price is for 1 side only.

*Preis: VORSICHT: Der Preis ist für eine einzelne Seite.

*Prix: ATTENTION: le prix est pour un seul côté.

Possibilità di formare 3° lato con modello LPF6 EVOF (pag. 383).
The 3rd side can be made with the LPF6 EVOF model (page 383).
Möglichkeit die 3. Seitenwand mit LPF6 EVOF-Modell (S. 383) einzubauen.
Possibilité de réaliser le 3e côté avec le modèle LPF6 EVOF (page 383).

PROFILO MAGGIORE ESTENSIBILITÀ

Wall profile adjustment - Verlängerungsprofil - Profilé pour extension supplémentaire

| Codice - Code Artikel - Article | Formato (cm) - Size Format - Dimension | + cm. | Prezzo (€) - Price Preis - Prix |
|------------------------------------|---|-------|------------------------------------|
| MTP 16E | 6,2 x 195 | 2,0 | 99,00 |

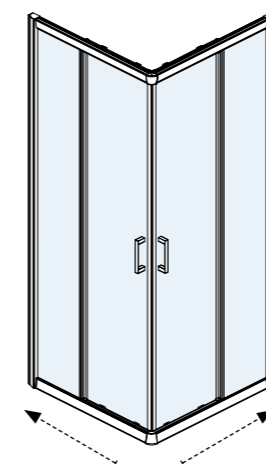
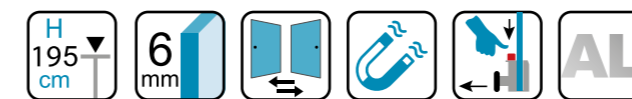

PROFILO A MURO WALL PROFILE - WANDPROFIL - PROFIL DE MUR

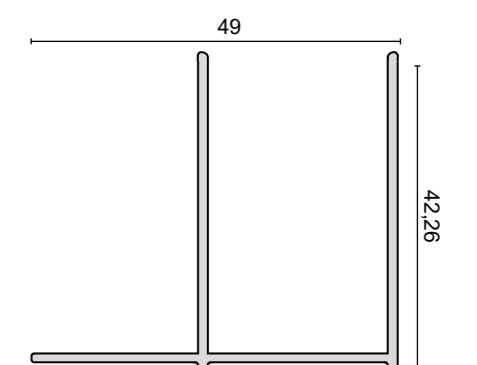

PANAREA EVO

CRISTALLO TRASPARENTE
 TRANSPARENT CRYSTAL
 TRANSPARENTES KRISTALLGLAS
 VERRRE TRANSPARENT

| CODICE Code - Artikel - Article | Formato (cm) Size - Format - Dimension | Estensibilità Extensibility Streckbarkeit - Extensibilité | Prezzo (€) Price - Preis - Prix | E cm | *R (cm) |
|---|--|--|---|----------------|-------------------|
| LS6 EVO 7946 | 70 x 90 | 67 ÷ 69 x 87 ÷ 89 | 760,00 | 36,0 | 38,0 |
| LS6 EVO 8046 | 80 x 80 | 77 ÷ 79 x 77 ÷ 79 | 767,00 | 38,0 | 55,0 |
| LS6 EVO 9046 | 90 x 90 | 87 ÷ 89 x 87 ÷ 89 | 798,00 | 48,0 | 55,0 |

*R: **Raggio di curvatura** - Radius - Krümmungsradius - Rayon de courbure

Possibilità di formare 3° lato con modello LPF6 EVO (pag. 381).
 The 3rd side can be made with the LPF6 EVO model (page 381).
 Möglichkeit die 3. Seitenwand mit LPF6 EVO-Modell (S. 381) einzubauen.
 Possibilité de réaliser le 3e côté avec le modèle LPF6 EVO (page 381).

PROFILO MAGGIORE ESTENSIBILITÀ

Wall profile adjustment - Verlängerungsprofil - Profilé pour extension supplémentaire

| Codice - Code Artikel - Article | Formato (cm) - Size Format - Dimension | + cm. | Prezzo (€) - Price Preis - Prix |
|---|--|--------------|---|
| MTP 16E | 6,2 x 195 | 2,0 | 99,00 |

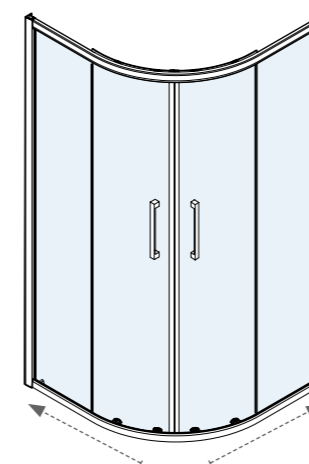
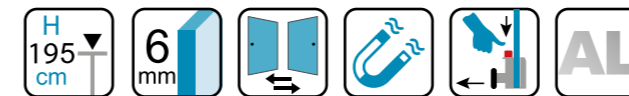

PROFILO A MURO WALL PROFILE - WANDPROFIL - PROFIL DE MUR

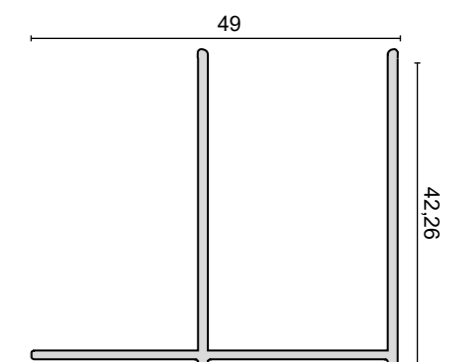

PANAREA EVO MATT

CRISTALLO SATINATO
MATT CRYSTAL
SATINIERTES KRISTALLGLAS
VERRE MAT

| CODICE <i>Code - Artikel - Article</i> | Formato (cm) <i>Size - Format - Dimension</i> | Estensibilità <i>Extensibility Streckbarkeit - Extensibilité</i> | Prezzo (€) <i>Price - Preis - Prix</i> |  | *R <i>(cm)</i> |
|---|--|---|---|---|-------------------|
| LS6 EVO 7946M | 70 x 90 | 67 ÷ 69 x 87 ÷ 89 | 851,00 | 36,0 | 38,0 |
| LS6 EVO 8046M | 80 x 80 | 77 ÷ 79 x 77 ÷ 79 | 857,00 | 38,0 | 55,0 |
| LS6 EVO 9046M | 90 x 90 | 87 ÷ 89 x 87 ÷ 89 | 890,00 | 48,0 | 55,0 |

*R: **Raggio di curvatura** - Radius - Krümmungsradius - Rayon de courbure

Possibilità di formare 3° lato con modello LPF6 EVOM (pag. 383).
The 3rd side can be made with the LPF6 EVOM model (page 383).
Möglichkeit die 3. Seitenwand mit LPF6 EVOM-Modell (S. 383) einzubauen.
Possibilité de réaliser le 3e côté avec le modèle LPF6 EVOM (page 383).

PROFILO MAGGIORE ESTENSIBILITÀ

Wall profile adjustment - Verlängerungsprofil - Profilé pour extension supplémentaire

| Codice - Code Artikel - Article | Formato (cm) - Size Format - Dimension | + cm. | Prezzo (€) - Price Preis - Prix |
|------------------------------------|---|-------|------------------------------------|
| MTP 16E | 6,2 x 195 | 2,0 | 99,00 |

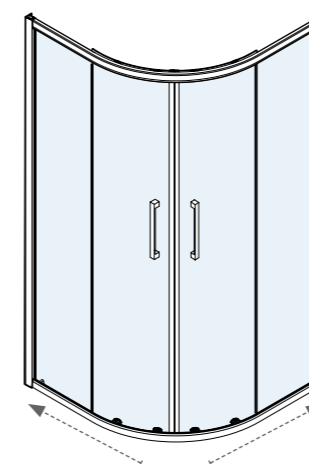
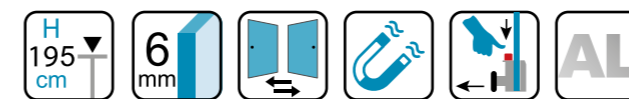

PROFILO A MURO WALL PROFILE - WANDPROFIL - PROFIL DE MUR

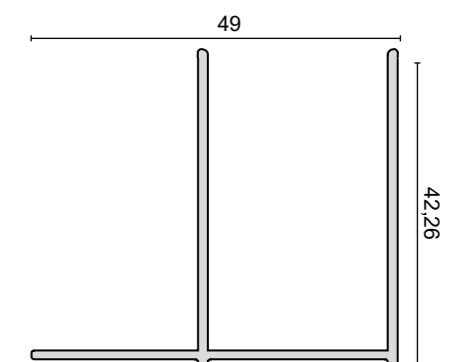

PANAREA EVO FOX

CRISTALLO PIUMATO
FOX CRYSTAL
FOX KRISTALLGLAS
VERRE GRANITÉ

| CODICE <i>Code - Artikel - Article</i> | Formato (cm) <i>Size - Format - Dimension</i> | Estensibilità <i>Extensibility Streckbarkeit - Extensibilité</i> | Prezzo (€) <i>Price - Preis - Prix</i> | E <small>cm</small> | *R <small>(cm)</small> |
|---|--|---|---|-------------------------------|---------------------------|
| LS6 EVO 7946F | 70 x 90 | 67 ÷ 69 x 87 ÷ 89 | 823,00 | 36,0 | 38,0 |
| LS6 EVO 8046F | 80 x 80 | 77 ÷ 79 x 77 ÷ 79 | 827,00 | 38,0 | 55,0 |
| LS6 EVO 9046F | 90 x 90 | 87 ÷ 89 x 87 ÷ 89 | 851,00 | 48,0 | 55,0 |

*R: **Raggio di curvatura** - Radius - Krümmungsradius - Rayon de courbure

Possibilità di formare 3° lato con modello LPF6 EVOF (pag. 383).
The 3rd side can be made with the LPF6 EVOF model (page 383).
Möglichkeit die 3. Seitenwand mit LPF6 EVOF-Modell (S. 383) einzubauen.
Possibilité de réaliser le 3e côté avec le modèle LPF6 EVOF (page 383).

PROFILO MAGGIORE ESTENSIBILITÀ

Wall profile adjustment - Verlängerungsprofil - Profilé pour extension supplémentaire

| Codice - Code Artikel - Article | Formato (cm) - Size Format - Dimension | + cm. | Prezzo (€) - Price Preis - Prix |
|------------------------------------|---|-------|------------------------------------|
| MTP 16E | 6,2 x 195 | 2,0 | 99,00 |

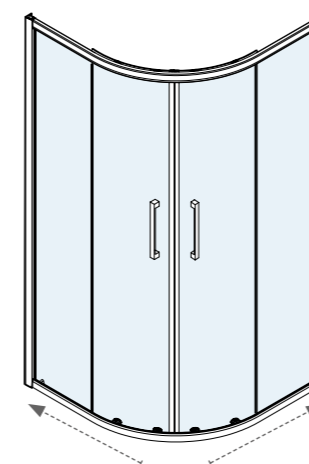
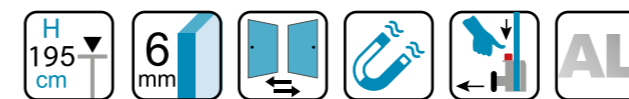

PROFILO A MURO WALL PROFILE - WANDPROFIL - PROFIL DE MUR

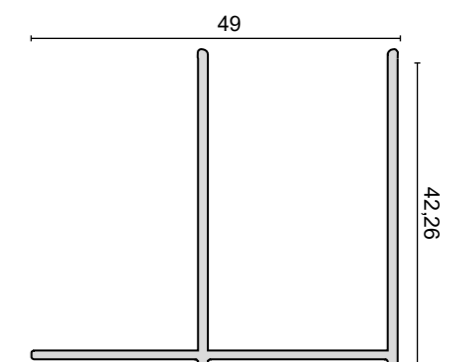



ORTIGIA

CRISTALLO TRASPARENTE
 TRANSPARENT CRYSTAL
 TRANSPARENTES KRISTALLGLAS
 VERRE TRANSPARENT

| CODICE <i>Code - Artikel - Article</i> | Formato (cm) <i>Size - Format - Dimension</i> | Estensibilità <i>Extensibility Streckbarkeit - Extensibilité</i> | Prezzo (€) <i>Price - Preis - Prix</i> | E <i>cm</i> | Lato porta <i>Door Tür - Porte</i> |
|--|---|--|--|-----------------------|--|
| LA6N EVO 90 | 90 | 87,5 ÷ 91,5 | 482,00 | 36 | • |
| LA6N EVO 100 | 100 | 97,5 ÷ 101,5 | 522,00 | 41 | • |
| LA6N EVO 110 | 110 | 107,5 ÷ 111,5 | 524,00 | 46 | • |
| LA6N EVO 120 | 120 | 117,5 ÷ 121,5 | 526,00 | 51 | • |
| LA6N EVO 130 | 130 | 127,5 ÷ 131,5 | 593,00 | 56 | • |
| LA6N EVO 140 | 140 | 137,5 ÷ 141,5 | 595,00 | 61 | • |
| LA6N EVO 150 | 150 | 147,5 ÷ 151,5 | 700,00 | 66 | • |
| LA6N EVO 160 | 160 | 157,5 ÷ 161,5 | 735,00 | 71 | • |

6 mm
 SCORREVOLI
 SLIDING

PROFILO MAGGIORE ESTENSIBILITÀ

Wall profile adjustment - Verlängerungsprofil - Profilé pour extension supplémentaire

| Codice - Code <i>Artikel - Article</i> | Formato (cm) - Size <i>Format - Dimension</i> | + cm. | Prezzo (€) - Price <i>Preis - Prix</i> |
|--|---|--------------|--|
| MTP 16E | 6,2 x 195 | 2,0 | 99,00 |

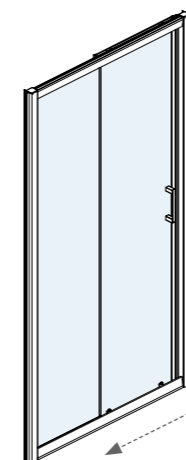
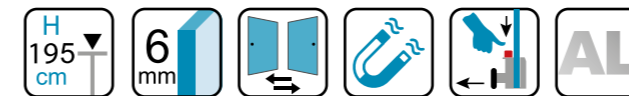

PROFILO A MURO WALL PROFILE - WANDPROFIL - PROFIL DE MUR

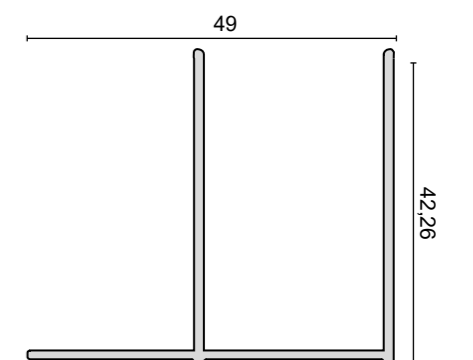

ORTIGIA

CRISTALLO TRASPARENTE
 TRANSPARENT CRYSTAL
 TRANSPARENTES KRISTALLGLAS
 VERRE TRANSPARENT



| CODICE Code - Artikel - Article | Formato (cm) Size - Format - Dimension | Estensibilità Extensibility Streckbarkeit - Extensibilität | Prezzo (€) Price - Preis - Prix | E cm | Lato porta Door Tür - Porte |
|---|--|---|---|----------------|--|
| LA6N EVO 90 | 90 | 87,5 ÷ 91,5 | 482,00 | 36 | • |
| LA6N EVO 100 | 100 | 97,5 ÷ 101,5 | 522,00 | 41 | • |
| LA6N EVO 110 | 110 | 107,5 ÷ 111,5 | 524,00 | 46 | • |
| LA6N EVO 120 | 120 | 117,5 ÷ 121,5 | 526,00 | 51 | • |
| LA6N EVO 130 | 130 | 127,5 ÷ 131,5 | 593,00 | 56 | • |
| LA6N EVO 140 | 140 | 137,5 ÷ 141,5 | 595,00 | 61 | • |
| LA6N EVO 150 | 150 | 147,5 ÷ 151,5 | 700,00 | 66 | • |
| LA6N EVO 160 | 160 | 157,5 ÷ 161,5 | 735,00 | 71 | • |

Parete fissa - Pezzi da ordinare
 Side - Necessary pieces
 Seite - Notwendige Stücke
 Paroi fixe - Paroi à commander

| | | | | |
|---------------|----|---------|--------|---|
| LPF6 EVO 7016 | 70 | 67 ÷ 69 | 336,00 | 1 |
| LPF6 EVO 7516 | 75 | 72 ÷ 74 | 358,00 | 1 |
| LPF6 EVO 8016 | 80 | 77 ÷ 79 | 360,00 | 1 |
| LPF6 EVO 9016 | 90 | 87 ÷ 89 | 384,00 | 1 |

PROFILO MAGGIORE ESTENSIBILITÀ

Wall profile adjustment - Verlängerungsprofil - Profilé pour extension supplémentaire

| Codice - Code Artikel - Article | Formato (cm) - Size Format - Dimension | + cm. | Prezzo (€) - Price Preis - Prix |
|---|--|--------------|---|
| MTP 16E | 6,2 x 195 | 2,0 | 99,00 |

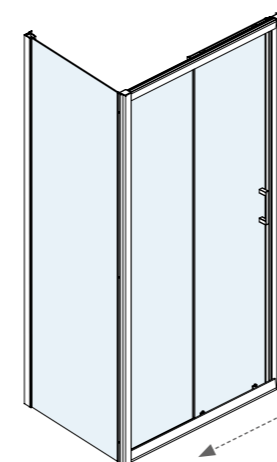
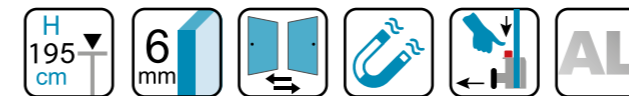

PROFILO A MURO

WALL PROFILE - WANDPROFIL - PROFIL DE MUR

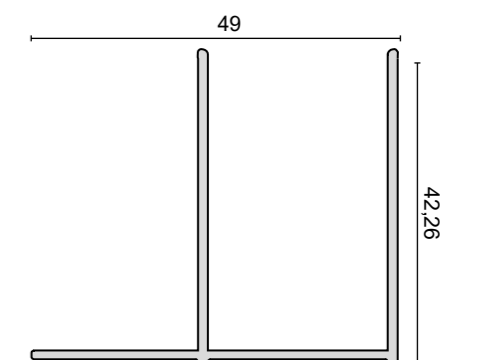



ORTIGIA

CRISTALLO TRASPARENTE
 TRANSPARENT CRYSTAL
 TRANSPARENTES KRISTALLGLAS
 VERRE TRANSPARENT

| CODICE Code - Artikel - Article | Formato (cm) Size - Format - Dimension | Estensibilità Extensibility Streckbarkeit - Extensibilität | Prezzo (€) Price - Preis - Prix | E cm | Lato porta Door Tür - Porte |
|---|--|---|---|----------------|--|
| LA6N EVO 90 | 90 | 87,5 ÷ 91,5 | 482,00 | 36 | • |
| LA6N EVO 100 | 100 | 97,5 ÷ 101,5 | 522,00 | 41 | • |
| LA6N EVO 110 | 110 | 107,5 ÷ 111,5 | 524,00 | 46 | • |
| LA6N EVO 120 | 120 | 117,5 ÷ 121,5 | 526,00 | 51 | • |
| LA6N EVO 130 | 130 | 127,5 ÷ 131,5 | 593,00 | 56 | • |
| LA6N EVO 140 | 140 | 137,5 ÷ 141,5 | 595,00 | 61 | • |
| LA6N EVO 150 | 150 | 147,5 ÷ 151,5 | 700,00 | 66 | • |
| LA6N EVO 160 | 160 | 157,5 ÷ 161,5 | 735,00 | 71 | • |

Parete fissa - Pezzi da ordinare
 Side - Necessary pieces
 Seite - Notwendige Stücke
 Paroi fixe - Paroi à commander

| | | | | |
|---------------|----|---------|--------|---|
| LPF6 EVO 7016 | 70 | 67 ÷ 69 | 336,00 | 2 |
| LPF6 EVO 7516 | 75 | 72 ÷ 74 | 358,00 | 2 |
| LPF6 EVO 8016 | 80 | 77 ÷ 79 | 360,00 | 2 |
| LPF6 EVO 9016 | 90 | 87 ÷ 89 | 384,00 | 2 |

PROFILO MAGGIORE ESTENSIBILITÀ

Wall profile adjustment - Verlängerungsprofil - Profilé pour extension supplémentaire

| Codice - Code Artikel - Article | Formato (cm) - Size Format - Dimension | + cm. | Prezzo (€) - Price Preis - Prix |
|---|--|--------------|---|
| MTP 16E | 6,2 x 195 | 2,0 | 99,00 |

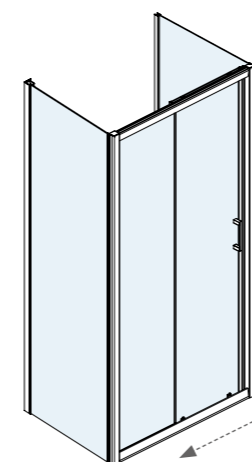
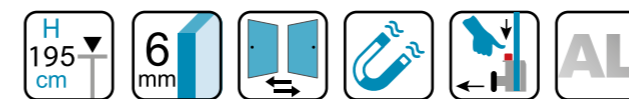

PROFILO A MURO WALL PROFILE - WANDPROFIL - PROFIL DE MUR

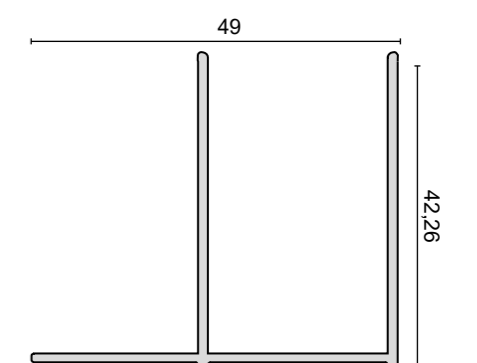

ORTIGIA MATT

CRISTALLO SATINATO
MATT CRYSTAL
SATINIERTES KRISTALLGLAS
VERRE MAT

| CODICE <i>Code - Artikel - Article</i> | Formato (cm) <i>Size - Format - Dimension</i> | Estensibilità <i>Extensibility</i> <i>Streckbarkeit - Extensibilité</i> | Prezzo (€) <i>Price - Preis - Prix</i> | E <i>cm</i> | Lato porta <i>Door</i> <i>Tür - Porte</i> |
|--|---|--|--|-----------------------|--|
| LA6N EVO 90M | 90 | 87,5 ÷ 91,5 | 515,00 | 36 | • |
| LA6N EVO 100M | 100 | 97,5 ÷ 101,5 | 522,00 | 41 | • |
| LA6N EVO 110M | 110 | 107,5 ÷ 111,5 | 545,00 | 46 | • |
| LA6N EVO 120M | 120 | 117,5 ÷ 121,5 | 566,00 | 51 | • |
| LA6N EVO 130M | 130 | 127,5 ÷ 131,5 | 623,00 | 56 | • |
| LA6N EVO 140M | 140 | 137,5 ÷ 141,5 | 625,00 | 61 | • |

6 mm
SCORREVOLI
SLIDING

PROFILO MAGGIORE ESTENSIBILITÀ

Wall profile adjustment - Verlängerungsprofil - Profilé pour extension supplémentaire

| Codice - Code <i>Artikel - Article</i> | Formato (cm) - Size <i>Format - Dimension</i> | + cm. | Prezzo (€) - Price <i>Preis - Prix</i> |
|--|---|--------------|--|
| MTP 16E | 6,2 x 195 | 2,0 | 99,00 |

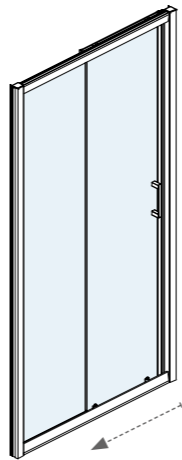
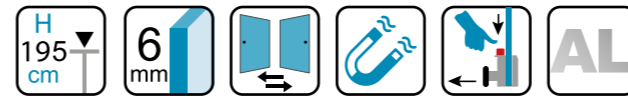

PROFILO A MURO WALL PROFILE - WANDPROFIL - PROFIL DE MUR

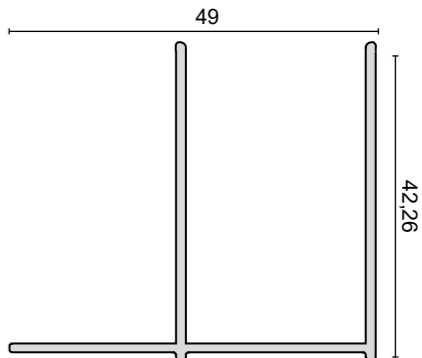



ORTIGIA MATT

CRISTALLO SATINATO
MATT CRYSTAL
SATINIERTES KRISTALLGLAS
VERRE MAT

| CODICE <i>Code - Artikel - Article</i> | Formato (cm) <i>Size - Format - Dimension</i> | Estensibilità <i>Extensibility Streckbarkeit - Extensibilité</i> | Prezzo (€) <i>Price - Preis - Prix</i> | E <i>cm</i> | Lato porta <i>Door Tür - Porte</i> |
|---|--|---|---|-----------------------|---|
| LA6N EVO 90M | 90 | 87,5 ÷ 91,5 | 515,00 | 36 | • |
| LA6N EVO 100M | 100 | 97,5 ÷ 101,5 | 522,00 | 41 | • |
| LA6N EVO 110M | 110 | 107,5 ÷ 111,5 | 545,00 | 46 | • |
| LA6N EVO 120M | 120 | 117,5 ÷ 121,5 | 566,00 | 51 | • |
| LA6N EVO 130M | 130 | 127,5 ÷ 131,5 | 623,00 | 56 | • |
| LA6N EVO 140M | 140 | 137,5 ÷ 141,5 | 625,00 | 61 | • |

Parete fissa - Pezzi da ordinare
*Side - Necessary pieces
Seite - Notwendige Stücke
Paroi fixe - Paroi à commander*

| | | | | |
|----------------|----|---------|--------|---|
| LPF6 EVO 7016M | 70 | 67 ÷ 69 | 369,00 | 1 |
| LPF6 EVO 7516M | 75 | 72 ÷ 74 | 393,00 | 1 |
| LPF6 EVO 8016M | 80 | 77 ÷ 79 | 395,00 | 1 |
| LPF6 EVO 9016M | 90 | 87 ÷ 89 | 417,00 | 1 |

PROFILO MAGGIORE ESTENSIBILITÀ

Wall profile adjustment - Verlängerungsprofil - Profilé pour extension supplémentaire

| Codice - Code <i>Artikel - Article</i> | Formato (cm) - Size <i>Format - Dimension</i> | + cm. | Prezzo (€) - Price <i>Preis - Prix</i> |
|---|--|-------|---|
| MTP 16E | 6,2 x 195 | 2,0 | 99,00 |

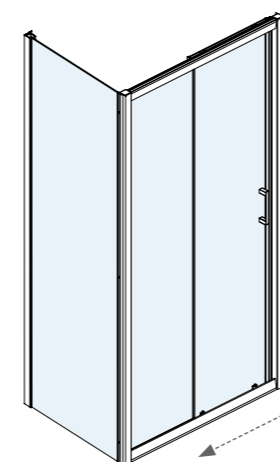
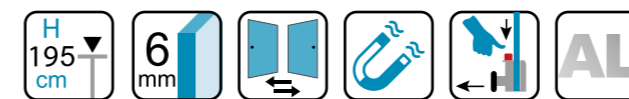

PROFILO A MURO WALL PROFILE - WANDPROFIL - PROFIL DE MUR

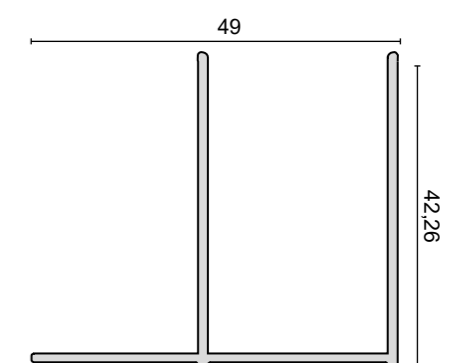



ORTIGIA MATT

CRISTALLO SATINATO
MATT CRYSTAL
SATINIERTES KRISTALLGLAS
VERRE MAT

| CODICE <i>Code - Artikel - Article</i> | Formato (cm) <i>Size - Format - Dimension</i> | Estensibilità <i>Extensibility Streckbarkeit - Extensibilité</i> | Prezzo (€) <i>Price - Preis - Prix</i> | E <i>cm</i> | Lato porta <i>Door Tür - Porte</i> |
|---|--|---|---|-----------------------|---|
| LA6N EVO 90M | 90 | 87,5 ÷ 91,5 | 515,00 | 36 | • |
| LA6N EVO 100M | 100 | 97,5 ÷ 101,5 | 522,00 | 41 | • |
| LA6N EVO 110M | 110 | 107,5 ÷ 111,5 | 545,00 | 46 | • |
| LA6N EVO 120M | 120 | 117,5 ÷ 121,5 | 566,00 | 51 | • |
| LA6N EVO 130M | 130 | 127,5 ÷ 131,5 | 623,00 | 56 | • |
| LA6N EVO 140M | 140 | 137,5 ÷ 141,5 | 625,00 | 61 | • |

Parete fissa - Pezzi da ordinare
*Side - Necessary pieces
Seite - Notwendige Stücke
Paroi fixe - Paroi à commander*

| | | | | |
|----------------|----|---------|--------|---|
| LPF6 EVO 7016M | 70 | 67 ÷ 69 | 369,00 | 2 |
| LPF6 EVO 7516M | 75 | 72 ÷ 74 | 393,00 | 2 |
| LPF6 EVO 8016M | 80 | 77 ÷ 79 | 395,00 | 2 |
| LPF6 EVO 9016M | 90 | 87 ÷ 89 | 417,00 | 2 |

PROFILO MAGGIORE ESTENSIBILITÀ

Wall profile adjustment - Verlängerungsprofil - Profilé pour extension supplémentaire

| Codice - Code Artikel - Article | Formato (cm) - Size Format - Dimension | + cm. | Prezzo (€) - Price Preis - Prix |
|------------------------------------|---|-------|------------------------------------|
| MTP 16E | 6,2 x 195 | 2,0 | 99,00 |

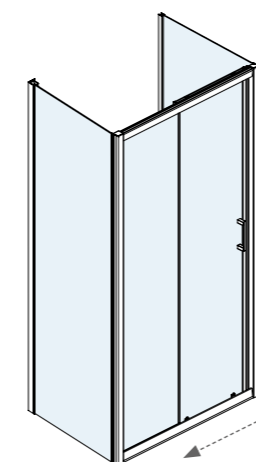
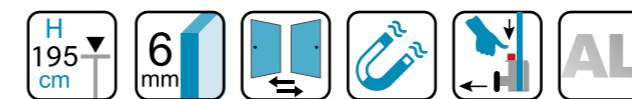

PROFILO A MURO WALL PROFILE - WANDPROFIL - PROFIL DE MUR

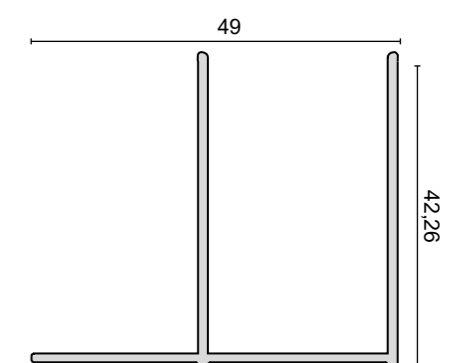

ORTIGIA FOX

CRISTALLO PIUMATO
FOX CRYSTAL
FOX KRISTALLGLAS
VERRE GRANITÉ

| CODICE <i>Code - Artikel - Article</i> | Formato (cm) <i>Size - Format - Dimension</i> | Estensibilità <i>Extensibility Streckbarkeit - Extensibilité</i> | Prezzo (€) <i>Price - Preis - Prix</i> | E <i>cm</i> | Lato porta <i>Door Tür - Porte</i> |
|---|--|---|---|-----------------------|---|
| LA6N EVO 90F | 90 | 87,5 ÷ 91,5 | 515,00 | 36 | • |
| LA6N EVO 100F | 100 | 97,5 ÷ 101,5 | 522,00 | 41 | • |
| LA6N EVO 110F | 110 | 107,5 ÷ 111,5 | 545,00 | 46 | • |
| LA6N EVO 120F | 120 | 117,5 ÷ 121,5 | 566,00 | 51 | • |
| LA6N EVO 130F | 130 | 127,5 ÷ 131,5 | 623,00 | 56 | • |
| LA6N EVO 140F | 140 | 137,5 ÷ 141,5 | 625,00 | 61 | • |

6 mm
SCORREVOLI
SLIDING

PROFILO MAGGIORE ESTENSIBILITÀ

Wall profile adjustment - Verlängerungsprofil - Profilé pour extension supplémentaire

| Codice - Code Artikel - Article | Formato (cm) - Size Format - Dimension | + cm. | Prezzo (€) - Price Preis - Prix |
|------------------------------------|---|-------|------------------------------------|
| MTP 16E | 6,2 x 195 | 2,0 | 99,00 |

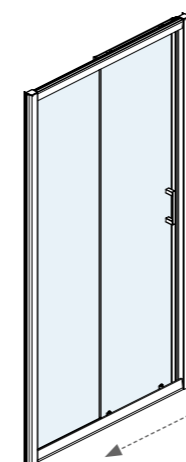
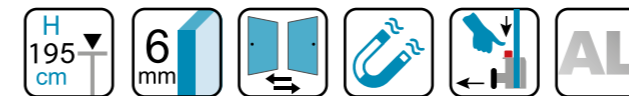

PROFILO A MURO WALL PROFILE - WANDPROFIL - PROFIL DE MUR

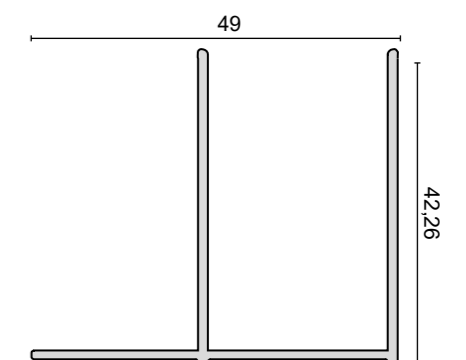

ORTIGIA FOX

CRISTALLO PIUMATO
FOX CRYSTAL
FOX KRISTALLGLAS
VERRE GRANITÉ



| CODICE <i>Code - Artikel - Article</i> | Formato (cm) <i>Size - Format - Dimension</i> | Estensibilità <i>Extensibility Streckbarkeit - Extensibilité</i> | Prezzo (€) <i>Price - Preis - Prix</i> | E <i>cm</i> | Lato porta <i>Door Tür - Porte</i> |
|---|--|---|---|-----------------------|---|
| LA6N EVO 90F | 90 | 87,5 ÷ 91,5 | 515,00 | 36 | • |
| LA6N EVO 100F | 100 | 97,5 ÷ 101,5 | 522,00 | 41 | • |
| LA6N EVO 110F | 110 | 107,5 ÷ 111,5 | 545,00 | 46 | • |
| LA6N EVO 120F | 120 | 117,5 ÷ 121,5 | 566,00 | 51 | • |
| LA6N EVO 130F | 130 | 127,5 ÷ 131,5 | 623,00 | 56 | • |
| LA6N EVO 140F | 140 | 137,5 ÷ 141,5 | 625,00 | 61 | • |

| Parete fissa - Pezzi da ordinare <i>Side - Necessary pieces Seite - Notwendige Stücke Paroi fixe - Paroi à commander</i> | | | | |
|---|----|---------|--------|---|
| LPF6 EVO 7016F | 70 | 67 ÷ 69 | 369,00 | 1 |
| LPF6 EVO 7516F | 75 | 72 ÷ 74 | 393,00 | 1 |
| LPF6 EVO 8016F | 80 | 77 ÷ 79 | 395,00 | 1 |
| LPF6 EVO 9016F | 90 | 87 ÷ 89 | 417,00 | 1 |

PROFILO MAGGIORE ESTENSIBILITÀ

Wall profile adjustment - Verlängerungsprofil - Profilé pour extension supplémentaire

| Codice - Code Artikel - Article | Formato (cm) - Size Format - Dimension | + cm. | Prezzo (€) - Price Preis - Prix |
|------------------------------------|---|-------|------------------------------------|
| MTP 16E | 6,2 x 195 | 2,0 | 99,00 |

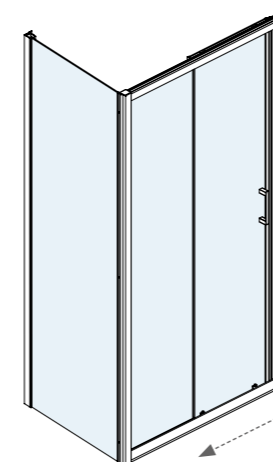
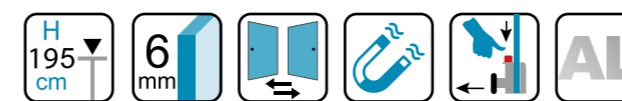

PROFILO A MURO WALL PROFILE - WANDPROFIL - PROFIL DE MUR

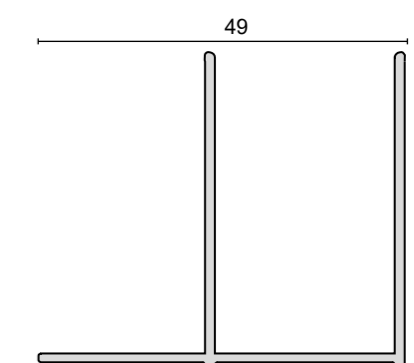



ORTIGIA FOX

CRISTALLO PIUMATO
FOX CRYSTAL
FOX KRISTALLGLAS
VERRE GRANITÉ

| CODICE <i>Code - Artikel - Article</i> | Formato (cm) <i>Size - Format - Dimension</i> | Estensibilità <i>Extensibility Streckbarkeit - Extensibilité</i> | Prezzo (€) <i>Price - Preis - Prix</i> | E <i>cm</i> | Lato porta <i>Door Tür - Porte</i> |
|---|--|---|---|-----------------------|---|
| LA6N EVO 90F | 90 | 87,5 ÷ 91,5 | 515,00 | 36 | • |
| LA6N EVO 100F | 100 | 97,5 ÷ 101,5 | 522,00 | 41 | • |
| LA6N EVO 110F | 110 | 107,5 ÷ 111,5 | 545,00 | 46 | • |
| LA6N EVO 120F | 120 | 117,5 ÷ 121,5 | 566,00 | 51 | • |
| LA6N EVO 130F | 130 | 127,5 ÷ 131,5 | 623,00 | 56 | • |
| LA6N EVO 140F | 140 | 137,5 ÷ 141,5 | 625,00 | 61 | • |

| Parete fissa - Pezzi da ordinare <i>Side - Necessary pieces Seite - Notwendige Stücke Paroi fixe - Paroi à commander</i> | | | | |
|---|----|---------|--------|---|
| LPF6 EVO 7016F | 70 | 67 ÷ 69 | 369,00 | 2 |
| LPF6 EVO 7516F | 75 | 72 ÷ 74 | 393,00 | 2 |
| LPF6 EVO 8016F | 80 | 77 ÷ 79 | 395,00 | 2 |
| LPF6 EVO 9016F | 90 | 87 ÷ 89 | 417,00 | 2 |

PROFILO MAGGIORE ESTENSIBILITÀ

Wall profile adjustment - Verlängerungsprofil - Profilé pour extension supplémentaire

| Codice - Code Artikel - Article | Formato (cm) - Size Format - Dimension | + cm. | Prezzo (€) - Price Preis - Prix |
|------------------------------------|---|-------|------------------------------------|
| MTP 16E | 6,2 x 195 | 2,0 | 99,00 |

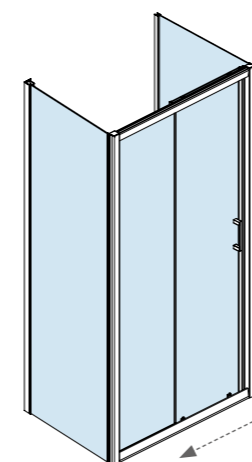
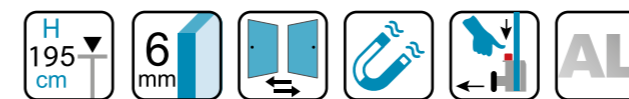

PROFILO A MURO WALL PROFILE - WANDPROFIL - PROFIL DE MUR

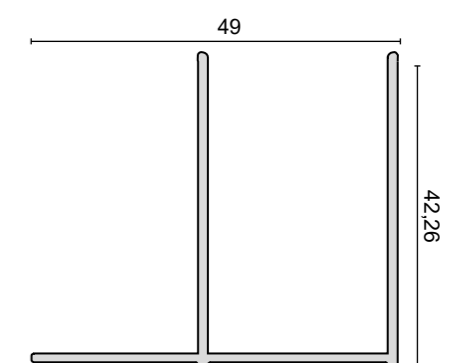



FORMICA

CRISTALLO TRASPARENTE
 TRANSPARENT CRYSTAL
 TRANSPARENTES KRISTALLGLAS
 VERRE TRANSPARENT

| CODICE <i>Code - Artikel - Article</i> | Formato (cm) <i>Size - Format - Dimension</i> | Estensibilità <i>Extensibility Streckbarkeit - Extensibilité</i> | Prezzo (€) <i>Price - Preis - Prix</i> | E <i>cm</i> | Lato porta <i>Door Tür - Porte</i> |
|--|---|--|--|-----------------------|--|
| LL6 7026 | 70 | 67 ÷ 71 | 532,00 | 36 | • |
| LL6 7526 | 75 | 72 ÷ 76 | 548,00 | 41 | • |
| LL6 8026 | 80 | 77 ÷ 81 | 576,00 | 46 | • |
| LL6 9026 | 90 | 87 ÷ 91 | 593,00 | 51 | • |
| LL6 10026 | 100 | 97 ÷ 101 | 616,00 | 56 | • |

6 mm
 SCORREVOLI
 SLIDING

PROFILO MAGGIORE ESTENSIBILITÀ

Wall profile adjustment - Verlängerungsprofil - Profilé pour extension supplémentaire

| Codice - Code <i>Artikel - Article</i> | Formato (cm) - Size <i>Format - Dimension</i> | + cm. | Prezzo (€) - Price <i>Preis - Prix</i> |
|--|---|--------------|--|
| MTP 16E | 6,2 x 195 | 2,0 | 99,00 |

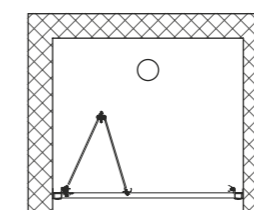
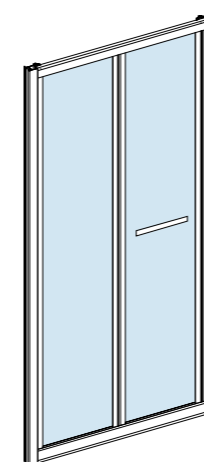

PROFILO A MURO WALL PROFILE - WANDPROFIL - PROFIL DE MUR

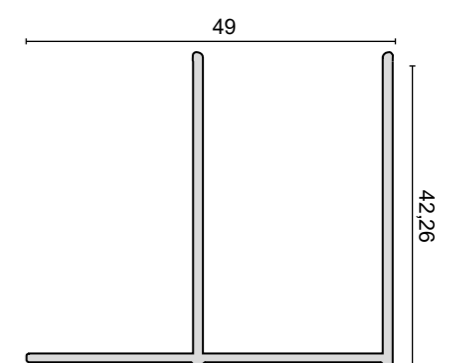



FORMICA

CRISTALLO TRASPARENTE
 TRANSPARENT CRYSTAL
 TRANSPARENTES KRISTALLGLAS
 VERRE TRANSPARENT

| CODICE Code - Artikel - Article | Formato (cm) Size - Format - Dimension | Estensibilità Extensibility Streckbarkeit - Extensibilität | Prezzo (€) Price - Preis - Prix | E cm | Lato porta Door Tür - Porte |
|---|--|---|---|----------------|--|
| LL6 7026 | 70 | 67 ÷ 71 | 532,00 | 36 | • |
| LL6 7526 | 75 | 72 ÷ 76 | 548,00 | 41 | • |
| LL6 8026 | 80 | 77 ÷ 81 | 576,00 | 46 | • |
| LL6 9026 | 90 | 87 ÷ 91 | 593,00 | 51 | • |
| LL6 10026 | 100 | 97 ÷ 101 | 616,00 | 56 | • |

| Parete fissa - Pezzi da ordinare Side - Necessary pieces Seite - Notwendige Stücke Paroi fixe - Paroi à commander | | | | |
|---|----|---------|--------|---|
| LPF6 EVO 7016 | 70 | 67 ÷ 69 | 336,00 | 1 |
| LPF6 EVO 7516 | 75 | 72 ÷ 74 | 358,00 | 1 |
| LPF6 EVO 8016 | 80 | 77 ÷ 79 | 360,00 | 1 |
| LPF6 EVO 9016 | 90 | 87 ÷ 89 | 384,00 | 1 |

PROFILO MAGGIORE ESTENSIBILITÀ

Wall profile adjustment - Verlängerungsprofil - Profilé pour extension supplémentaire

| Codice - Code Artikel - Article | Formato (cm) - Size Format - Dimension | + cm. | Prezzo (€) - Price Preis - Prix |
|---|--|--------------|---|
| MTP 16E | 6,2 x 195 | 2,0 | 99,00 |

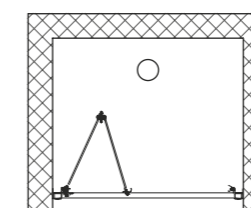
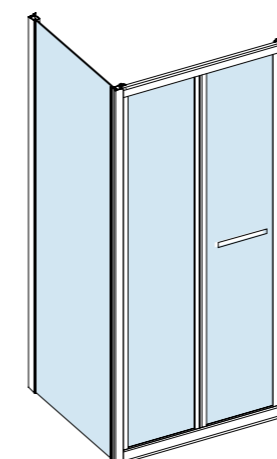

PROFILO A MURO WALL PROFILE - WANDPROFIL - PROFIL DE MUR

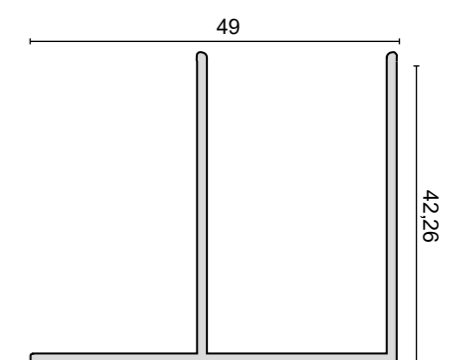



FORMICA

CRISTALLO TRASPARENTE
 TRANSPARENT CRYSTAL
 TRANSPARENTE KRISTALLGLAS
 VERRE TRANSPARENT

| CODICE Code - Artikel - Article | Formato (cm) Size - Format - Dimension | Estensibilità Extensibility Streckbarkeit - Extensibilité | Prezzo (€) Price - Preis - Prix | E cm | Lato porta Door Tür - Porte |
|---|--|--|---|----------------|--|
| LL6 7026 | 70 | 67 ÷ 71 | 532,00 | 36 | • |
| LL6 7526 | 75 | 72 ÷ 76 | 548,00 | 41 | • |
| LL6 8026 | 80 | 77 ÷ 81 | 576,00 | 46 | • |
| LL6 9026 | 90 | 87 ÷ 91 | 593,00 | 51 | • |
| LL6 10026 | 100 | 97 ÷ 101 | 616,00 | 56 | • |

Parete fissa - Pezzi da ordinare
 Side - Necessary pieces
 Seite - Notwendige Stücke
 Paroi fixe - Paroi à commander

| | | | | |
|---------------|----|---------|--------|----------|
| LPF6 EVO 7016 | 70 | 67 ÷ 69 | 336,00 | 2 |
| LPF6 EVO 7516 | 75 | 72 ÷ 74 | 358,00 | 2 |
| LPF6 EVO 8016 | 80 | 77 ÷ 79 | 360,00 | 2 |
| LPF6 EVO 9016 | 90 | 87 ÷ 89 | 384,00 | 2 |

PROFILO MAGGIORE ESTENSIBILITÀ

Wall profile adjustment - Verlängerungsprofil - Profilé pour extension supplémentaire

| Codice - Code Artikel - Article | Formato (cm) - Size Format - Dimension | + cm. | Prezzo (€) - Price Preis - Prix |
|---|--|--------------|---|
| MTP 16E | 6,2 x 195 | 2,0 | 99,00 |

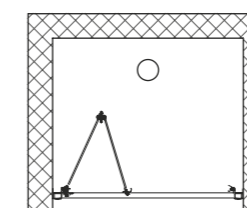
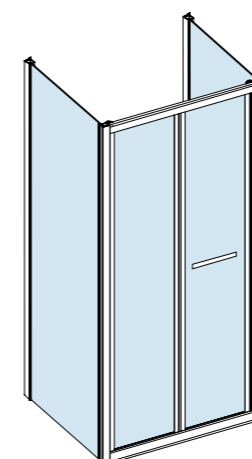

PROFILO A MURO

WALL PROFILE - WANDPROFIL - PROFIL DE MUR

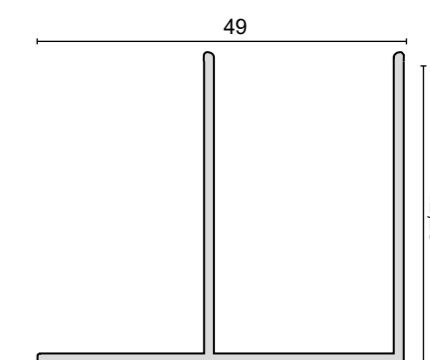



PANAREA EVO

CRISTALLO TRASPARENTE
 TRANSPARENT CRYSTAL
 TRANSPARENTES KRISTALLGLAS
 VERRE TRANSPARENT

| CODICE <i>Code - Artikel - Article</i> | Formato (cm) <i>Size - Format - Dimension</i> | Estensibilità <i>Extensibility - Streckbarkeit - Extensibilité</i> | Prezzo (€) <i>Price - Preis - Prix</i> |
|--|---|--|--|
| LPF6 EVO7016 | 70 | 67 ÷ 69 | 336,00 |
| LPF6 EVO7516 | 75 | 72 ÷ 74 | 358,00 |
| LPF6 EVO8016 | 80 | 77 ÷ 79 | 360,00 |
| LPF6 EVO9016 | 90 | 87 ÷ 89 | 384,00 |

6 mm
 SCORREVOLI
 SLIDING

PROFILO MAGGIORE ESTENSIBILITÀ

Wall profile adjustment - Verlängerungsprofil - Profilé pour extension supplémentaire

| Codice - Code <i>Artikel - Article</i> | Formato (cm) - Size <i>Format - Dimension</i> | + cm. | Prezzo (€) - Price <i>Preis - Prix</i> |
|--|---|--------------|--|
| MTP 16E | 6,2 x 195 | 2,0 | 99,00 |

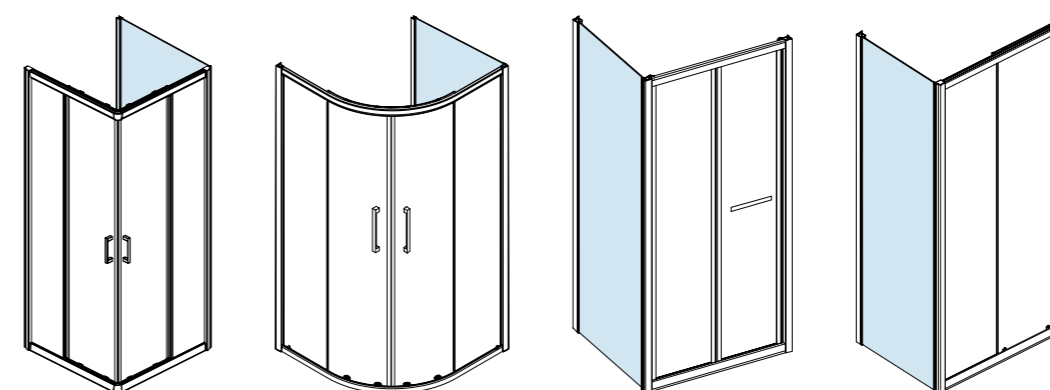

PROFILO A MURO - WALL PROFILE
 WANDPROFIL - PROFIL DE MUR

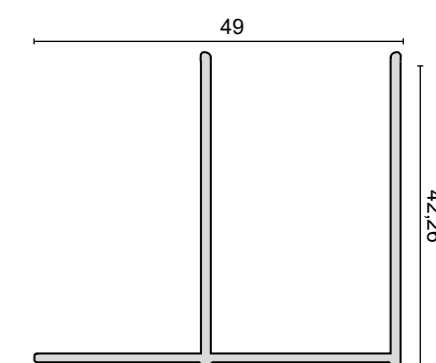

PANAREA EVO MATT / FOX

CRISTALLO SATINATO / PIUMATO
 MATT CRYSTAL - FOX CRYSTAL
 SATINIERTES KRISTALLGLAS - FOX KRISTALLGLAS
 VERRE MAT - VERRE GRANITÉ

| CODICE <i>Code - Artikel - Article</i> | Formato (cm) <i>Size - Format - Dimension</i> | Estensibilità <i>Extensibility - Streckbarkeit - Extensibilité</i> | Prezzo (€) <i>Price - Preis - Prix</i> |
|--|---|--|--|
| LPF6 EVO7016M | 70 | 67 ÷ 69 | 369,00 |
| LPF6 EVO7516M | 75 | 72 ÷ 74 | 393,00 |
| LPF6 EVO8016M | 80 | 77 ÷ 79 | 395,00 |
| LPF6 EVO9016M | 90 | 87 ÷ 89 | 417,00 |
| LPF6 EVO7016F | 70 | 67 ÷ 69 | 369,00 |
| LPF6 EVO7516F | 75 | 72 ÷ 74 | 393,00 |
| LPF6 EVO8016F | 80 | 77 ÷ 79 | 395,00 |
| LPF6 EVO9016F | 90 | 87 ÷ 89 | 417,00 |

Cristallo piumato - Fox crystal
 Fox Kristallglas - Verre granité

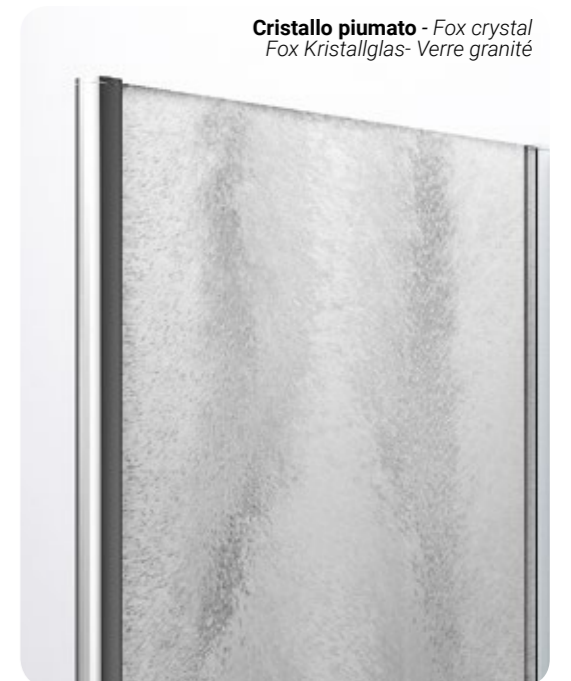

PROFILO MAGGIORE ESTENSIBILITÀ

Wall profile adjustment - Verlängerungsprofil - Profilé pour extension supplémentaire

| Codice - Code <i>Artikel - Article</i> | Formato (cm) - Size <i>Format - Dimension</i> | + cm. | Prezzo (€) - Price <i>Preis - Prix</i> |
|--|---|--------------|--|
| MTP 16E | 6,2 x 195 | 2,0 | 99,00 |

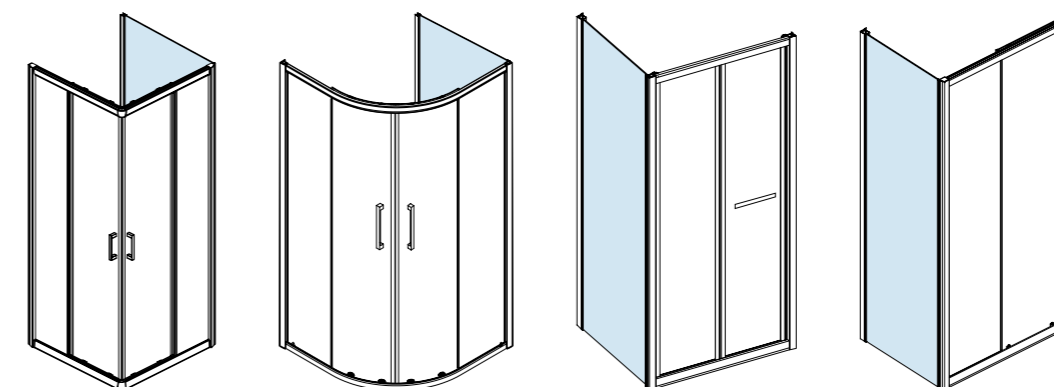

PROFILO A MURO - WALL PROFILE
 WANDPROFIL - PROFIL DE MUR

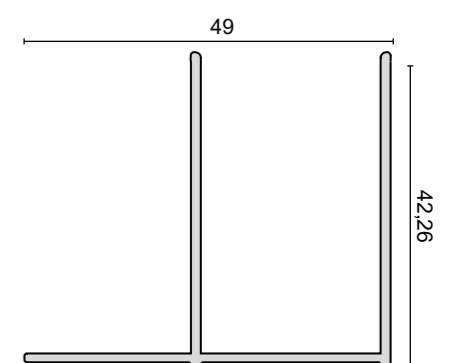

6 mm
 SCORREVOLI
 SLIDING

PANAREA EVO / ORTIGIA / FORMICA

LACUS RIVESTE... SU MISURA - LACUS MAKES IT... TO MEASURE - LACUS FERTIG ...MASSGERECHT - LACUS UNE FABRICATION SUR ...MESURE

Articoli speciali su ordinazione - Special Items on request - Sonderanfertigungen auf Bestellung - Articles 'à la carte' sur commande

| LATO FISSO - FIXED PANEL FESTE SEITENWAND - PANNEAU FIXE | LATO PORTA DOOR - TÜR - PORTE | VETRO SOPRA MURETTO - GLASS ON THE WALL GLAS AN DER WAND - PAROI SUR MURET |
|---|--|---|
| Altezza max 195 cm. - Larghezza max 140 cm. Height max 195 cm. - Width max 140 cm. Maximale Höhe 195 cm. - Maximale Breite 140 cm. Hauteur 195 cm. maximum - Largeur 140 cm. maximum | PANAREA E. Altezza max 195 cm. - Larghezza max 140 cm. Height max 195 cm. - Width max 140 cm. Maximale Höhe 195 cm. - Maximale Breite 140 cm. Hauteur 195 cm. maximum - Largeur 140 cm. maximum | NON DISPONIBILE UNAVAILABLE NICHT VERFÜGBAR PAS DISPONIBLE |
| | ORTIGIA Altezza max 195 cm. - Larghezza max 180 cm. Height max 195 cm. - Width max 180 cm. Maximale Höhe 195 cm. - Maximale Breite 180 cm. Hauteur 195 cm. maximum - Largeur 180 cm. maximum | |
| | FORMICA Altezza max 195 cm. - Larghezza max 100 cm. Height max 195 cm. - Width max 100 cm. Maximale Höhe 195 cm. - Maximale Breite 100 cm. Hauteur 195 cm. maximum - Largeur 100 cm. maximum | |



| PREZZO DI LISTINO AL PEZZO (TRASPARENTE) GROSS PREIS PRO PIECE (TRANSPARENT) LISTENPREIS PRO STÜCK (TRANSPARENT) PRIX TARIF PAR PIÈCE (TRANSPARENT) | PREVENTIVO SU RICHIESTA PRICE ON REQUEST ANGEBOT AUF ANFRAGE DEVIS SUR DEMANDE | NON DISPONIBILE UNAVAILABLE NICHT VERFÜGBAR PAS DISPONIBLE |
|--|---|---|
|--|---|---|

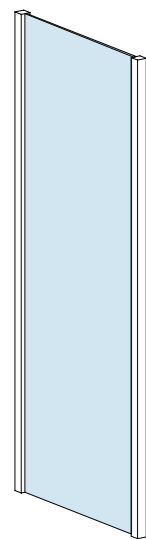

| | |
|---|----------|
| FASCIA 1: da 0,01 a 0,50 mq Level 1: from 0.01 to 0.5 sqm | € 527,00 |
| FASCIA 2: da 0,51 a 1,00 mq Level 2: from 0.51 to 1.0 sqm | € 606,00 |
| FASCIA 3: da 1,01 a 1,50 mq Level 3: from 1.01 to 1.5 sqm | € 703,00 |
| FASCIA 4: da 1,51 a 2,00 mq Level 4: from 1.51 to 2.0 sqm | € 786,00 |
| FASCIA 5: da 2,01 a 2,50 mq Level 5: from 2.01 to 2.5 sqm | € 869,00 |
| FASCIA 6: da 2,51 a 3,00 mq Level 6: from 2.51 to 3.0 sqm | € 976,00 |



PANAREA EVO

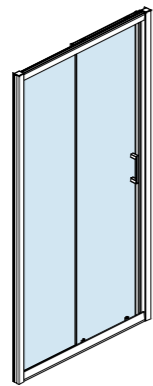

ORTIGIA

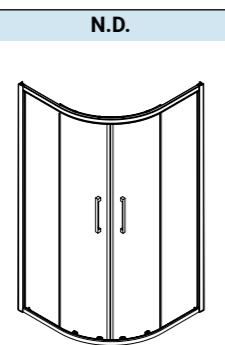

PANAREA EVO

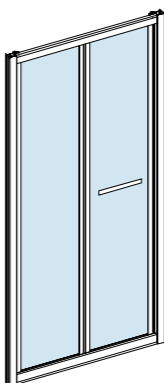

FORMICA

Maggiorazione per vetro Matt, Fox e Gray: +15%
 Surcharge for matt, fox and grey crystal + 15%
 Aufpreis für Matt, Fox und Grey Kristallglas +15%
 Majoration pour les verres Matt, Fox et Grey: +15%

ATTENZIONE:
CALCOLARE I MQ. DEL PEZZO PER STABILIRE LA FASCIA DI APPARTENENZA
 Per soluzioni diverse da quelle contemplate contattare ns. ufficio tecnico per avere indicazioni di fattibilità e prezzi.

VORSICHT:
BERECHNEN DIE QM. DES STÜCKES, ZUR ERFÜLLUNG DER ZUGEHÖRIGEN BAND
 Für andere als die in Betracht gezogenen Lösungen wenden Sie sich an unser technisches Büro, um Informationen zu Machbarkeit und Preisen zu erhalten.

ATTENTION:
CALCULATE THE SQM OF THE ARTIKEL TO ESTABLISH THE BELONGING LEVEL.
 For information on feasibility and prices of other solutions, please get in touch with our technical dept.

ATTENTION:
CALCULER LES M². DE LA PAROI POUR ÉTABLIR LA TRANCHE D'APPARTENANCE
 Pour d'autres solutions que celles envisagées, contactez notre bureau technique pour connaître la faisabilité et les tarifs.

DETTAGLI & CARATTERISTICHE



PANAREA EVO
CORNER - CORNER
 ECKPROFIL - PROFILÉ D'ANGLE

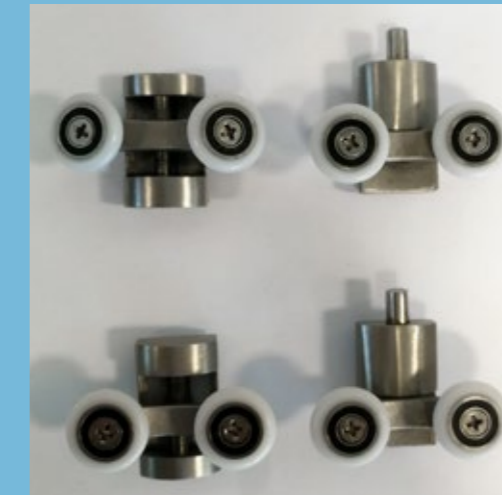

PANAREA / ORTIGIA
CARRUCOLE - ROLLERS
 RIEMENSCHLEIBE - ROULETTE



PANAREA / ORTIGIA
PROFILO INFERIORE - BOTTOM PROFILE
 UNTERES PROFIL - PROFILÉ INFÉRIEUR

6 mm
 SCORREVOLI
 SLIDING



FORMICA / PANAREA
MANIGLIA - HANDLE - GRIFF - POIGNÉE



FORMICA
CERNIERE - HINGE - SCHARNIER - CHARNIÈRE

CARATTERISTICHE GENERALI

- Cristallo temperato da 6 mm.
- Finitura trasparente, satinato, piumato.
- Profilo in alluminio cromo.
- Chiusura magnetica delle ante.
- Doppia Clips a sgancio per la pulizia dei cristalli.
- Estensione da 2 cm.
- Maniglie in acciaio inox.

GENERAL CHARACTERISTICS

- Tempered crystal 6 mm.
- Transparent - matt - fox.
- Chrome aluminum profile.
- Magnetic waterproof closure.
- Double opening clips for easy cleaning.
- Wall profile adjustment 2 cm.
- Handle made of stainless steel.

TECHNISCHE MERKMALE

- Sekuritkristallglas 6 mm stark.
- Kristallglasfinish: Transparent, matt, fox.
- Poliertes Chrom Profil.
- Magnetverschluss.
- Lösbare Tür zur Kristallreinigung.
- Streckbarkeit 2 cm.
- Griff aus Rostfreie Stahl.

SPECIFICATIONS GENERALES

- Verre trempé de 6 mm.
- Finition du verre: transparent, mat, granité.
- Profilé en aluminium chromé.
- Portes à fermeture magnétique.
- Portes déclipantes dans la partie basse pour le nettoyage du verre.
- Extensibilité de 2 cm.
- Poignée en acier.



TRATTAMENTO ANTICALCARE

Descaling
Entkalkungsbehandlung
Traitement anticalcaire



CAPRI WALL

CRISTALLO TRASPARENTE
TRANSPARENT CRYSTAL
TRANSPARENTES KRISTALLGLAS
VERRE TRANSPARENT

| CODICE <small>Code - Artikel - Article</small> | Formato (cm) <small>Size - Format - Dimension</small> | Estensibilità <small>Extensibility - Streckbarkeit - Extensibilité</small> | Prezzo (€) <small>Price - Preis - Prix</small> | E <small>cm</small> |
|--|---|--|--|-------------------------------|
| LCWI 1208 | 120 | 117,5 ÷ 119 | 1.201,00 | 48,0 |
| LCWI 1308 | 130 | 127,5 ÷ 129 | 1.265,00 | 53,0 |
| LCWI 1408 | 140 | 137,5 ÷ 139 | 1.328,00 | 58,0 |
| LCWI 1508 | 150 | 147,5 ÷ 149 | 1.392,00 | 63,0 |
| LCWI 1608 | 160 | 157,5 ÷ 159 | 1.454,00 | 68,0 |
| LCWI 1708 | 170 | 167,5 ÷ 169 | 1.519,00 | 73,0 |
| LCWI 1808 | 180 | 177,5 ÷ 179 | 1.582,00 | 78,0 |

Profilo maggiore estensibilità

Wall profile adjustment - Verlängerungsprofil - Profilé pour extension supplémentaire

| Codice - Code <small>Artikel - Article</small> | Formato (cm) - Size <small>Format - Dimension</small> | + cm. | Prezzo (€) - Price <small>Preis - Prix</small> |
|--|---|--------------|--|
| MTP 24 | 4,6 x 210 | 1,5 | 102,00 |

8 mm
OPEN SPACE

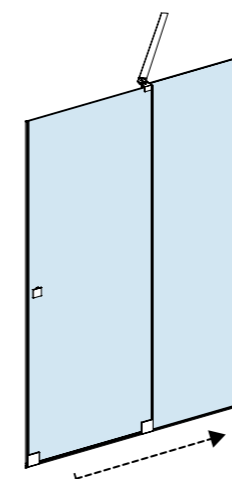
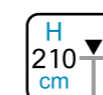

PROFILO A MURO
WALL PROFILE - WANDPROFIL - PROFIL DE MUR

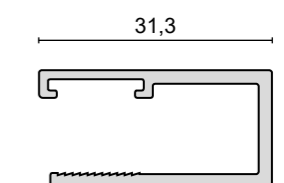

TRATTAMENTO ANTICALCARE

Descaling
Entkalkungsbehandlung
Traitement anticalcaire



CAPRI WALL MIRROR

CRISTALLO A SPECCHIO / TRASPARENTE
MIRROR / TRANSPARENT CRYSTAL
SPIEGEL- / TRANSPARENTES KRISTALLGLAS
VERRE MIROIR ET TRANSPARENT

| CODICE <i>Code - Artikel - Article</i> | Formato (cm) <i>Size - Format - Dimension</i> | Estensibilità <i>Extensibility - Streckbarkeit - Extensibilité</i> | Prezzo (€) <i>Price - Preis - Prix</i> | E <i>cm</i> |
|--|---|--|--|-----------------------|
| LCWIM 1208 | 120 | 117,5 ÷ 119 | 1.339,00 | 48,0 |
| LCWIM 1308 | 130 | 127,5 ÷ 129 | 1.434,00 | 53,0 |
| LCWIM 1408 | 140 | 137,5 ÷ 139 | 1.527,00 | 58,0 |
| LCWIM 1508 | 150 | 147,5 ÷ 149 | 1.623,00 | 63,0 |
| LCWIM 1608 | 160 | 157,5 ÷ 159 | 1.717,00 | 68,0 |
| LCWIM 1708 | 170 | 167,5 ÷ 169 | 1.812,00 | 73,0 |
| LCWIM 1808 | 180 | 177,5 ÷ 179 | 1.934,00 | 78,0 |

Profilo maggiore estensibilità

Wall profile adjustment - Verlängerungsprofil - Profilé pour extension supplémentaire

| Codice - Code <i>Artikel - Article</i> | Formato (cm) - Size <i>Format - Dimension</i> | + cm. | Prezzo (€) - Price <i>Preis - Prix</i> |
|--|---|--------------|--|
| MTP 24 | 4,6 x 210 | 1,5 | 102,00 |

8 mm
OPEN SPACE

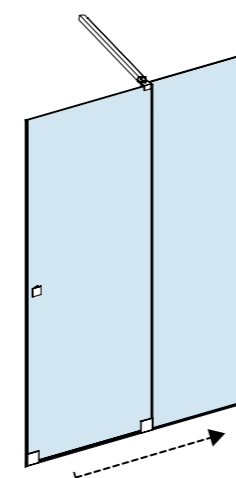

PROFILO A MURO
WALL PROFILE - WANDPROFIL - PROFIL DE MUR

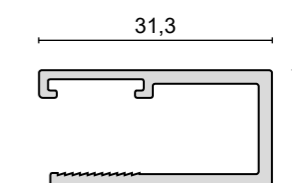

CAPRI WALL

LACUS RIVESTE... SU MISURA - LACUS MAKES IT... TO MEASURE - LACUS FERTIG ...MASSGERECHT - LACUS UNE FABRICATION SUR ...MESURE

Articoli speciali su ordinazione - Special Items on request - Sonderanfertigungen auf Bestellung - Articles 'à la carte' sur commande

LATO PORTA - DOOR - TÜR - PORTE

Altezza **max 210 cm.** - Larghezza **max 180 cm.**
 Height **max 210 cm.** - Width **max 180 cm.**
 Maximale Höhe **210 cm.** - Maximale Breite **180 cm.**
 Hauteur **210 cm. maximum** - Largeur **180 cm. maximum**



PREVENTIVO SU RICHIESTA

PRICE ON REQUEST
 ANGEBOT AUF ANFRAGE
 DEVIS SUR DEMANDE

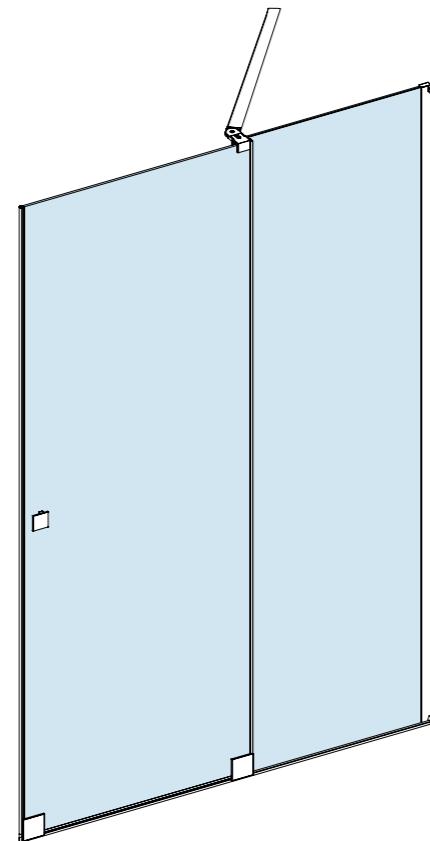

Per soluzioni diverse da quelle contemplate contattare ns. ufficio tecnico per avere indicazioni di fattibilità e prezzi.

For information on feasibility and prices of other solutions, please get in touch with our technical dept.

Für andere als die in Betracht gezogenen Lösungen wenden Sie sich an unser technisches Büro, um Informationen zu Machbarkeit und Preisen zu erhalten.

Pour des solutions autres que celles envisagées, contactez notre bureau technique pour connaître la faisabilité et les tarifs.

DETTAGLI & CARATTERISTICHE



BRACCIO SNODABILE - ADJUSTABLE ARM
 VERSTELLBARER ARM - BARRE DE RENFORT ARTICULÉE



POMOLO
 KNOB - KNOPF - POIGNÉE

8
 mm
 OPEN SPACE

CARATTERISTICHE GENERALI DELLA PARETE

- Cristallo temperato da 8 mm.
- Finitura trasparente e mirror.
- Profili in alluminio cromo lucido.
- Trattamento anticalcare.

GENERAL CHARACTERISTICS OF PANEL

- 8 mm tempered safety crystal.
- Crystal finishing: Transparent and mirror.
- Profiles made of chrome aluminium.
- Descaling.

TECHNISCHE MERKMALE

- Sekurirkristallglas 8 mm stark.
- Kristallfinish: Transparent und Spiegel.
- Poliertes-Verchromtes Aluminiumprofil.
- Entkalkungsbehandlung.

SPECIFICATIONS GENERALES DES PAROIS POUR ESPACE OUVERT

- Verre trempé 8 mm.
- Finition du verre: transparent et en miroir.
- Profils et barres de renfort en aluminium chromé.
- Traitement anticalcaire.

TRATTAMENTO ANTICALCARE

Descaling
Entkalkungsbehandlung
Traitement anticalcaire



FILICUDI

CRISTALLO TRASPARENTE
TRANSPARENT CRYSTAL
TRANSPARENTES KRISTALLGLAS
VERRE TRANSPARENT

| CODICE <i>Code - Artikel - Article</i> | Formato (cm) <i>Size - Format - Dimension</i> | Prezzo (€) <i>Price - Preis - Prix</i> |
|--|---|--|
| LOSA E 1008 | 98 x 200 | 563,00 |
| LOSA E 1108 | 108 x 200 | 591,00 |
| LOSA E 1208 | 118 x 200 | 629,00 |
| LOSA E 1308 | 128 x 200 | 689,00 |
| LOSA E 1408 | 138 x 200 | 692,00 |
| LOSA E 1508 | 148 x 200 | 713,00 |
| LOSA E 1608 | 158 x 200 | 769,00 |
| LOSA E 1708 | 168 x 200 | 788,00 |

Estensibilità del braccio cromo da 65 fino a 120 cm. - *Adjustment chrome arm from 65 to 120 cm.*
Streckbarkeit der verchromten Wandstange von 65 bis 120 cm. - *Extensibilité de la barre de renfort chromée de 65 à 120 cm.*

| | | |
|----------------|----------|-------|
| LBRS 01 | 60 ÷ 100 | 89,00 |
|----------------|----------|-------|

Braccio Quadrato a soffitto - *Ceiling square arm - Viereckige Deckstange - Barre de renfort carré fixation plafond*

| | | |
|----------------|----------|-------|
| LBRP 01 | 69 ÷ 128 | 89,00 |
|----------------|----------|-------|

Braccio pieghevole - *Joint arm - Gelenktragarm - Barre de renfort.*

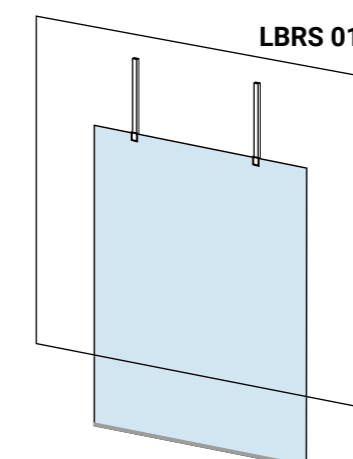
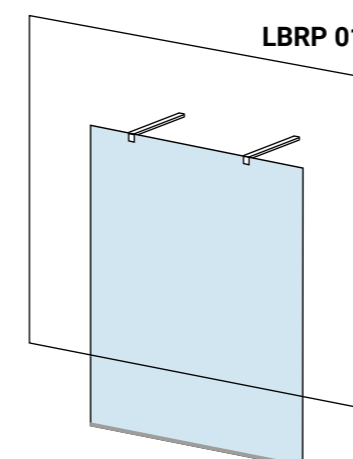
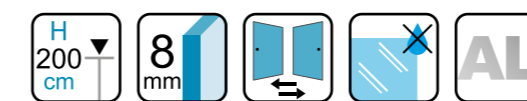

TRATTAMENTO ANTICALCARE

Descaling
Entkalkungsbehandlung
Traitement anticalcaire

FILICUDI INOX

CRISTALLO TRASPARENTE
TRANSPARENT CRYSTAL
TRANSPARENTES KRISTALLGLAS
VERRE TRANSPARENT

| CODICE Code - Artikel - Article | Formato (cm) Size - Format - Dimension | Prezzo (€) Price - Preis - Prix |
|---|--|---|
| LOSA E 1008 X | 98 x 200 | 629,00 |
| LOSA E 1108 X | 108 x 200 | 663,00 |
| LOSA E 1208 X | 118 x 200 | 697,00 |
| LOSA E 1308 X | 128 x 200 | 769,00 |
| LOSA E 1408 X | 138 x 200 | 772,00 |
| LOSA E 1508 X | 148 x 200 | 798,00 |
| LOSA E 1608 X | 158 x 200 | 861,00 |
| LOSA E 1708 X | 168 x 200 | 866,00 |

Braccio in acciaio inox spazzolato L.120 tagliabile - Cuttable brushed stainless steel arm L.120.
L.120 Schneidbarer Tragarm aus gebürstetem Edelstahl - Barre de renfort en acier brossé L. 120 découpable.

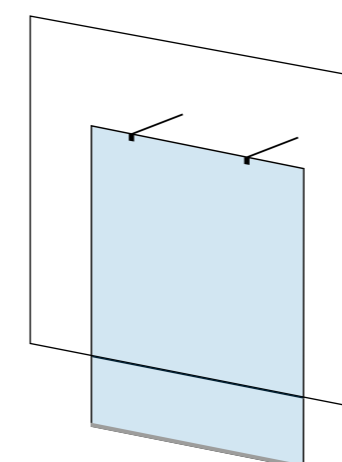
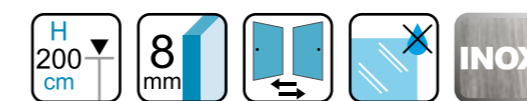
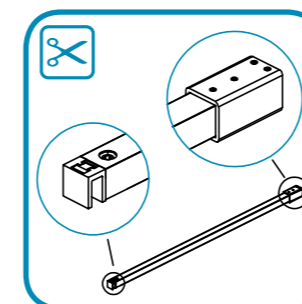

8 mm
OPEN SPACE

**TRATTAMENTO
ANTICALCARE**

Descaling
Entkalkungsbehandlung
Traitement anticalcaire



FILICUDI BLACK

CRISTALLO FUMÈ
GREY CRYSTAL
GRAUES KRISTALLGLAS
VERRE FUMÉ

| CODICE Code - Artikel - Article | Formato (cm) Size - Format - Dimension | Prezzo (€) Price - Preis - Prix |
|---|--|---|
| LOSA E 1008B | 98 x 200 | 592,00 |
| LOSA E 1108B | 108 x 200 | 624,00 |
| LOSA E 1208B | 118 x 200 | 665,00 |
| LOSA E 1308B | 128 x 200 | 729,00 |
| LOSA E 1408B | 138 x 200 | 734,00 |
| LOSA E 1508B | 148 x 200 | 758,00 |
| LOSA E 1608B | 158 x 200 | 818,00 |
| LOSA E 1708B | 168 x 200 | 820,00 |

Estensibilità del braccio nero satinato da 65 fino a 120 cm. - Adjustment black satin arm from 65 to 120 cm. -
Streckbarkeit der schwarz-satinierten Wandstange von 65 bis 120 cm. - Extensibilité de la barre de renfort satiné noire de 65 à 120 cm.

**8
mm**
OPEN SPACE

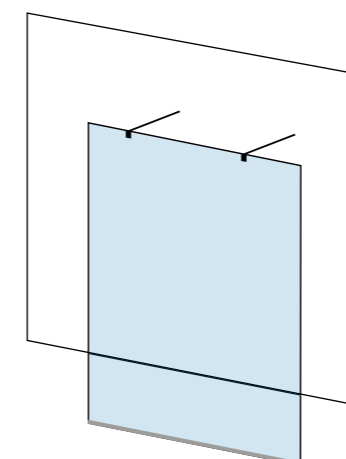
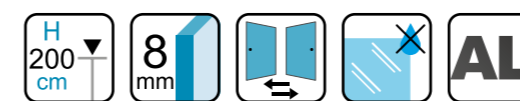

TRATTAMENTO ANTICALCARE

Descaling
Entkalkungsbehandlung
Traitement anticalcaire

FILICUDI WALL

CRISTALLO TRASPARENTE
TRANSPARENT CRYSTAL
TRANSPARENTES KRISTALLGLAS
VERRE TRANSPARENT

| CODICE Code - Artikel - Article | Formato (cm) Size - Format - Dimension | Estensibilità Extensibility - Streckbarkeit - Extensibilité | Prezzo (€) Price - Preis - Prix |
|---|--|---|---|
| LOSA EW 708 | 70 x 200 | 68,5 ÷ 70 | 479,00 |
| LOSA EW 808 | 80 x 200 | 78,5 ÷ 80 | 510,00 |
| LOSA EW 908 | 90 x 200 | 88,5 ÷ 90 | 535,00 |
| LOSA EW 1008 | 100 x 200 | 98,5 ÷ 100 | 564,00 |
| LOSA EW 1108 | 110 x 200 | 108,5 ÷ 110 | 595,00 |
| LOSA EW 1208 | 120 x 200 | 118,5 ÷ 120 | 629,00 |
| LOSA EW 1308 | 130 x 200 | 128,5 ÷ 130 | 688,00 |
| LOSA EW 1408 | 140 x 200 | 138,5 ÷ 140 | 691,00 |
| LOSA EW 1508 | 150 x 200 | 148,5 ÷ 150 | 718,00 |
| LOSA EW 1608 | 160 x 200 | 158,5 ÷ 160 | 773,00 |
| LOSA EW 1708 | 170 x 200 | 168,5 ÷ 170 | 777,00 |

Estensibilità del braccio cromo da 65 fino a 120 cm. - Adjustment chrome arm from 65 to 120 cm. -
Streckbarkeit der verchromten Wandstange von 65 bis 120 cm. - Extensibilité de la barre de renfort chromée de 65 à 120 cm.

| | | |
|--------------|----------|-------|
| LBR01 | 60 ÷ 100 | 89,00 |
|--------------|----------|-------|

Braccio Quadrato a soffitto - Ceiling square arm - Viereckige Deckstange - Barre de renfort carré fixation plafond

| | | |
|----------------|----------|-------|
| LBRP 01 | 69 ÷ 128 | 89,00 |
|----------------|----------|-------|

Braccio Pieghevole - Joint arm - Gelenkstange - Barre de renfort articulée.

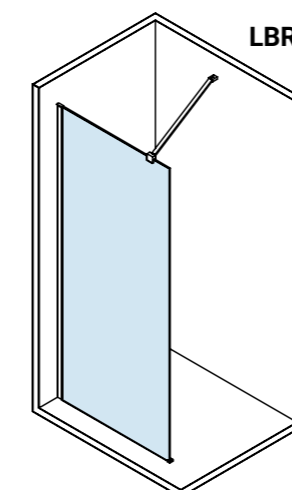
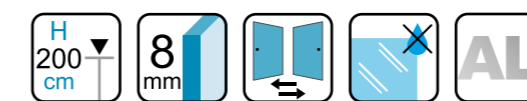

LBRP 01

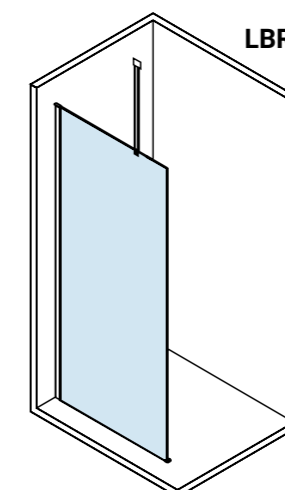

LBR01

PROFILO A MURO
WALL PROFILE - WANDPROFIL - PROFIL DE MUR

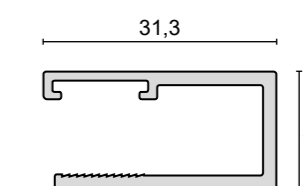

8 mm
OPEN SPACE

TRATTAMENTO ANTICALCARE

Descaling
Entkalkungsbehandlung
Traitement anticalcaire

FILICUDI WALL INOX

CRISTALLO TRASPARENTE
TRANSPARENT CRYSTAL
TRANSPARENTES KRISTALLGLAS
VERRE TRANSPARENT

| CODICE <i>Code - Artikel - Article</i> | Formato (cm) <i>Size - Format - Dimension</i> | Estensibilità <i>Extensibility - Streckbarkeit - Extensibilité</i> | Prezzo (€) <i>Price - Preis - Prix</i> |
|--|---|--|--|
| LOSA EW 708X | 70 x 200 | 68,5 ÷ 70 | 566,00 |
| LOSA EW 808X | 80 x 200 | 78,5 ÷ 80 | 594,00 |
| LOSA EW 908X | 90 x 200 | 88,5 ÷ 90 | 622,00 |
| LOSA EW 1008X | 100 x 200 | 98,5 ÷ 100 | 657,00 |
| LOSA EW 1108X | 110 x 200 | 108,5 ÷ 110 | 685,00 |
| LOSA EW 1208X | 120 x 200 | 118,5 ÷ 120 | 730,00 |
| LOSA EW 1308X | 130 x 200 | 128,5 ÷ 130 | 784,00 |
| LOSA EW 1408X | 140 x 200 | 138,5 ÷ 140 | 786,00 |
| LOSA EW 1508X | 150 x 200 | 148,5 ÷ 150 | 819,00 |
| LOSA EW 1608X | 160 x 200 | 158,5 ÷ 160 | 873,00 |
| LOSA EW 1708X | 170 x 200 | 168,5 ÷ 170 | 875,00 |

Braccio in acciaio inox spazzolato L.120 tagliabile - *Cuttable brushed stainless steel arm L.120.*
L.120 Schneidbarer Tragarm aus gebürstetem Edelstahl - Barre de renfort en acier brossé L. 120 découpable.

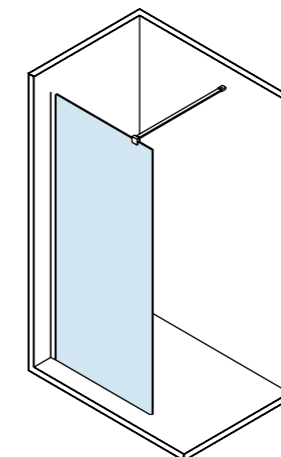
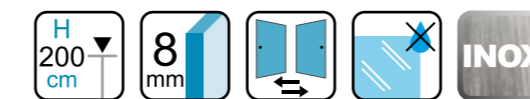
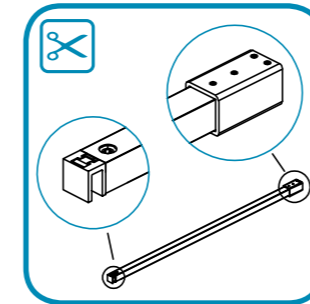

PROFILO A MURO
WALL PROFILE - WANDPROFIL - PROFIL DE MUR

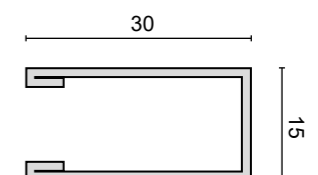

8 mm
OPEN SPACE

TRATTAMENTO ANTICALCARE

Descaling
Entkalkungsbehandlung
Traitement anticalcaire



FILICUDI WALL BT

CRISTALLO TRASPARENTE
TRANSPARENT CRYSTAL
TRANSPARENTES KRISTALLGLAS
VERRE TRANSPARENT

| CODICE <i>Code - Artikel - Article</i> | Formato (cm) <i>Size - Format - Dimension</i> | Estensibilità <i>Extensibility - Streckbarkeit - Extensibilité</i> | Prezzo (€) <i>Price - Preis - Prix</i> |
|--|---|--|--|
| LOSA EW 708BT | 70 x 200 | 68,5 ÷ 70 | 479,00 |
| LOSA EW 808BT | 80 x 200 | 78,5 ÷ 80 | 510,00 |
| LOSA EW 908BT | 90 x 200 | 88,5 ÷ 90 | 535,00 |
| LOSA EW 1008BT | 100 x 200 | 98,5 ÷ 100 | 564,00 |
| LOSA EW 1108BT | 110 x 200 | 108,5 ÷ 110 | 595,00 |
| LOSA EW 1208BT | 120 x 200 | 118,5 ÷ 120 | 629,00 |
| LOSA EW 1308BT | 130 x 200 | 128,5 ÷ 130 | 688,00 |
| LOSA EW 1408BT | 140 x 200 | 138,5 ÷ 140 | 690,00 |
| LOSA EW 1508BT | 150 x 200 | 148,5 ÷ 150 | 718,00 |
| LOSA EW 1608BT | 160 x 200 | 158,5 ÷ 160 | 775,00 |
| LOSA EW 1708BT | 170 x 200 | 168,5 ÷ 170 | 777,00 |

Estensibilità del braccio nero satinato da 65 fino a 120 cm. - Adjustment black satin arm from 65 to 120 cm.
Streckbarkeit der schwarz-satinierten Wandstange von 65 bis 120 cm. - Extensibilité de la barre de renfort satiné noire de 65 à 120 cm.

8 mm
OPEN SPACE

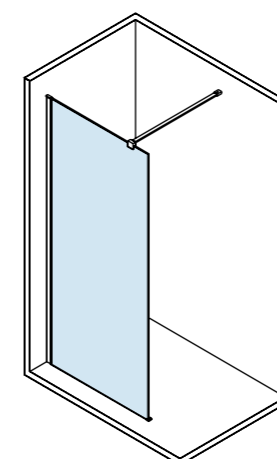
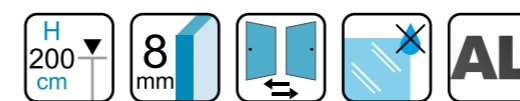

PROFILO A MURO
WALL PROFILE - WANDPROFIL - PROFIL DE MUR

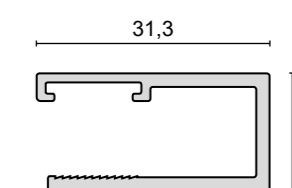

**TRATTAMENTO
ANTICALCARE**

Descaling
Entkalkungsbehandlung
Traitement anticalcaire

FILICUDI WALL BLACK

CRISTALLO FUMÈ
GREY CRYSTAL
GRAUES KRISTALLGLAS
VERRE FUMÉ

| CODICE Code - Artikel - Article | Formato (cm) Size - Format - Dimension | Estensibilità Extensibility - Streckbarkeit - Extensibilité | Prezzo (€) Price - Preis - Prix |
|---|--|---|---|
| LOSA EW 708B | 70 x 200 | 68,5 ÷ 70 | 499,00 |
| LOSA EW 808B | 80 x 200 | 78,5 ÷ 80 | 530,00 |
| LOSA EW 908B | 90 x 200 | 88,5 ÷ 90 | 560,00 |
| LOSA EW 1008B | 100 x 200 | 98,5 ÷ 100 | 595,00 |
| LOSA EW 1108B | 110 x 200 | 108,5 ÷ 110 | 629,00 |
| LOSA EW 1208B | 120 x 200 | 118,5 ÷ 120 | 668,00 |
| LOSA EW 1308B | 130 x 200 | 128,5 ÷ 130 | 728,00 |
| LOSA EW 1408B | 140 x 200 | 138,5 ÷ 140 | 730,00 |
| LOSA EW 1508B | 150 x 200 | 148,5 ÷ 150 | 763,00 |
| LOSA EW 1608B | 160 x 200 | 158,5 ÷ 160 | 827,00 |
| LOSA EW 1708B | 170 x 200 | 168,5 ÷ 170 | 830,00 |

Estensibilità del braccio nero satinato da 65 fino a 120 cm. - Adjustment black satin arm from 65 to 120 cm.
Streckbarkeit der schwarz-satinierten Wandstange von 65 bis 120 cm. - Extensibilité de la barre de renfort satiné noire de 65 à 120 cm.

**8
mm**
OPEN SPACE

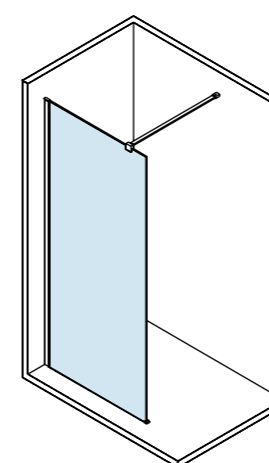
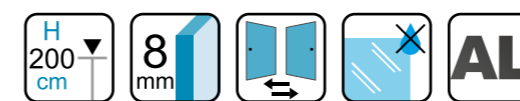

PROFILO A MURO
WALL PROFILE - WANDPROFIL - PROFIL DE MUR

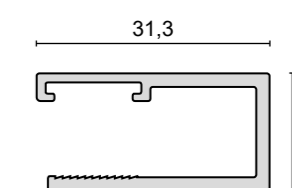

TRATTAMENTO ANTICALCARE

Descaling
Entkalkungsbehandlung
Traitement anticalcaire

FILICUDI WALL WHITE

CRISTALLO TRASPARENTE
TRANSPARENT CRYSTAL
TRANSPARENTES KRISTALLGLAS
VERRE TRANSPARENT

| CODICE <i>Code - Artikel - Article</i> | Formato (cm) <i>Size - Format - Dimension</i> | Estensibilità <i>Extensibility - Streckbarkeit - Extensibilité</i> | Prezzo (€) <i>Price - Preis - Prix</i> |
|--|---|--|--|
| LOSA EW 708W | 70 x 200 | 68,5 ÷ 70 | 479,00 |
| LOSA EW 808W | 80 x 200 | 78,5 ÷ 80 | 510,00 |
| LOSA EW 908W | 90 x 200 | 88,5 ÷ 90 | 535,00 |
| LOSA EW 1008W | 100 x 200 | 98,5 ÷ 100 | 564,00 |
| LOSA EW 1108W | 110 x 200 | 108,5 ÷ 110 | 595,00 |
| LOSA EW 1208W | 120 x 200 | 118,5 ÷ 120 | 629,00 |
| LOSA EW 1308W | 130 x 200 | 128,5 ÷ 130 | 688,00 |
| LOSA EW 1408W | 140 x 200 | 138,5 ÷ 140 | 690,00 |
| LOSA EW 1508W | 150 x 200 | 148,5 ÷ 150 | 718,00 |
| LOSA EW 1608W | 160 x 200 | 158,5 ÷ 160 | 775,00 |
| LOSA EW 1708W | 170 x 200 | 168,5 ÷ 170 | 777,00 |

Estensibilità del braccio bianco satinato da 65 fino a 120 cm. - Adjustment white arm from 65 to 120 cm.
Streckbarkeit der weiß-satinierten Wandstange von 65 bis 120 cm. - Extensibilité de la barre de renfort satiné blanche de 65 à 120 cm.

8 mm
OPEN SPACE

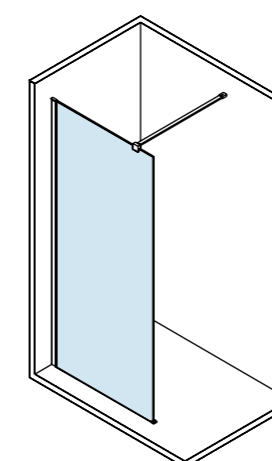
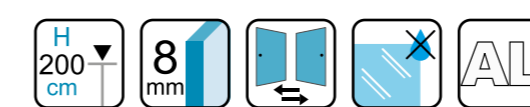

PROFILO A MURO
WALL PROFILE - WANDPROFIL - PROFIL DE MUR

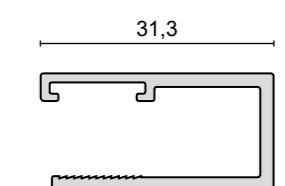

TRATTAMENTO ANTICALCARE

Descaling
Entkalkungsbehandlung
Traitement anticalcaire

FILICUDI CLOSED - CLOSED BT

CRISTALLO TRASPARENTE
TRANSPARENT CRYSTAL
TRANSPARENTES KRISTALLGLAS
VERRE TRANSPARENT

| CODICE CROMO Code Chrome Artikel Chrom Article Chromé | CODICE BLACK Code Matt black Artikel Schwarz Article Noir Satiné | Formato (cm) Size - Format - Dimension | Estensibilità Extensibility - Streckbarkeit - Extensibilité | Prezzo (€) Price - Preis - Prix | Lato lungo Door - Tür - Porte |
|---|--|--|---|---|---|
| LOSA EC1008 | LOSA EC1008BT | 100 | 100 ÷ 100,5 | 668,00 | • |
| LOSA EC1108 | LOSA EC1108BT | 110 | 110 ÷ 110,5 | 699,00 | • |
| LOSA EC1208 | LOSA EC1208BT | 120 | 120 ÷ 120,5 | 743,00 | • |
| LOSA EC1308 | LOSA EC1308BT | 130 | 130 ÷ 130,5 | 808,00 | • |
| LOSA EC1408 | LOSA EC1408BT | 140 | 140 ÷ 140,5 | 812,00 | • |
| LOSA EC1508 | LOSA EC1508BT | 150 | 150 ÷ 150,5 | 839,00 | • |
| LOSA EC1608 | LOSA EC1608BT | 160 | 160 ÷ 160,5 | 898,00 | • |
| LOSA EC1708 | LOSA EC1708BT | 170 | 170 ÷ 170,5 | 900,00 | • |

| | | | | | Lato corto Door - Tür - Porte |
|--------------------|----------------------|-----|--------------|--------|---|
| LOSA EW708 | LOSA EW708BT | 70 | 68,7 ÷ 70,2 | 479,00 | 1 |
| LOSA EW808 | LOSA EW808BT | 80 | 78,7 ÷ 80,2 | 510,00 | 1 |
| LOSA EW908 | LOSA EW908BT | 90 | 88,7 ÷ 90,2 | 535,00 | 1 |
| LOSA EW1008 | LOSA EW1008BT | 100 | 98,7 ÷ 100,2 | 564,00 | 1 |

8 mm
OPEN SPACE

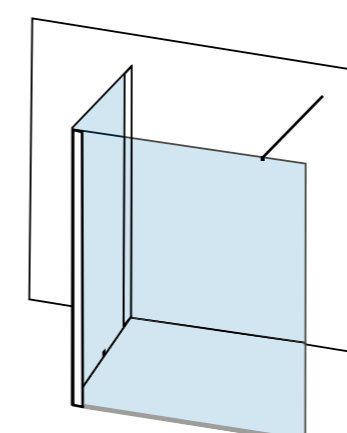
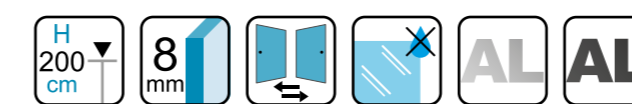

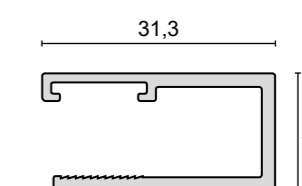

PROFILO A MURO
WALL PROFILE - WANDPROFIL - PROFIL DE MUR



FILICUDI / FILICUDI WALL

LACUS RIVESTE... SU MISURA - LACUS MAKES IT... TO MEASURE - LACUS FERTIG ...MASSGERECHT - LACUS UNE FABRICATION SUR ...MESURE

Articoli speciali su ordinazione - Special Items on request - Sonderanfertigungen auf Bestellung - Articles 'à la carte' sur commande

| FILICUDI / FILICUDI WALL | FILICUDI INOX / FILICUDI WALL INOX |
|---|---|
| <p>Altezza max 210 cm. - Larghezza max 180 cm. Height max 210 cm. - Width max 180 cm. Maximale Höhe 210 cm. - Maximale Breite 180 cm. Hauteur 210 cm. maximum - Largeur 180 cm. maximum</p> | <p>Altezza max 200 cm. - Larghezza max 180 cm. Height max 200 cm. - Width max 180 cm. Maximale Höhe 200 cm. - Maximale Breite 180 cm. Hauteur 200 cm. maximum - Largeur 180 cm. maximum</p> |
|  |  |
| <p>PREZZO DI LISTINO AL PEZZO (TRASPARENTE) GROSS PREIS PRO PIECE (TRANSPARENT) LISTENPREIS PRO STÜCK (TRANSPARENT) PRIX TARIF PAR PIÈCE (TRANSPARENT)</p> | <p>PREZZO DI LISTINO AL PEZZO (TRASPARENTE) GROSS PREIS PRO PIECE (TRANSPARENT) LISTENPREIS PRO STÜCK (TRANSPARENT) PRIX TARIF PAR PIÈCE (TRANSPARENT)</p> |

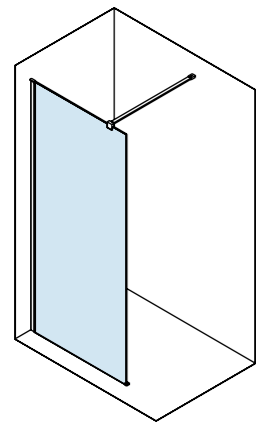
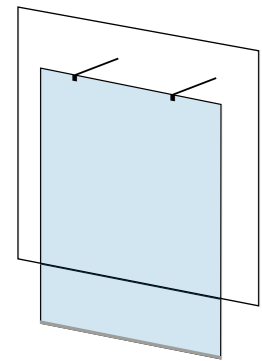

| | | | |
|---|-------------------|---|-------------------|
| <p>FASCIA 1: da 1,01 a 1,50 mq Level 1: from 1.01 to 1.5 sqm</p> | <p>€ 794,00</p> | <p>FASCIA 1: da 1,01 a 1,50 mq Level 1: from 1.01 to 1.5 sqm</p> | <p>€ 883,00</p> |
| <p>FASCIA 2: da 1,51 a 2,00 mq Level 2: from 1.51 to 2.0 sqm</p> | <p>€ 894,00</p> | <p>FASCIA 2: da 1,51 a 2,00 mq Level 2: from 1.51 to 2.0 sqm</p> | <p>€ 983,00</p> |
| <p>FASCIA 3: da 2,01 a 2,50 mq Level 3: from 2.01 to 2.5 sqm</p> | <p>€ 1.000,00</p> | <p>FASCIA 3: da 2,01 a 2,50 mq Level 3: from 2.01 to 2.5 sqm</p> | <p>€ 1.089,00</p> |
| <p>FASCIA 4: da 2,51 a 3,00 mq Level 4: from 2.51 to 3.0 sqm</p> | <p>€ 1.141,00</p> | <p>FASCIA 4: da 2,51 a 3,00 mq Level 4: from 2.51 to 3.0 sqm</p> | <p>€ 1.236,00</p> |
| <p>FASCIA 5: da 3,01 a 3,50 mq Level 5: from 3.01 to 3.5 sqm</p> | <p>€ 1.253,00</p> | <p>FASCIA 5: da 3,01 a 3,50 mq Level 5: from 3.01 to 3.5 sqm</p> | <p>€ 1.342,00</p> |
| <p>FASCIA 6: da 3,51 a 4,00 mq Level 6: from 3.51 to 4.0 sqm</p> | <p>€ 1.353,00</p> | <p>FASCIA 6: da 3,51 a 4,00 mq Level 6: from 3.51 to 4.0 sqm</p> | <p>€ 1.447,00</p> |

Maggiorazione per vetro Matt e Grey: +15%

Surcharge for matt and grey crystal + 15% - Aufpreis für Matt und Grey Kristallglas +15% - Majoration pour les verres Matt e Grey: +15%

ATTENZIONE:

CALCOLARE I MQ. DEL PEZZO PER STABILIRE LA FASCIA DI APPARTENENZA
Per soluzioni diverse da quelle contemplate contattare ns. ufficio tecnico per avere indicazioni di fattibilità e prezzi.

VORSICHT:

BERECHNEN DIE QM. DES STÜCKES, ZUR ERFÜLLUNG DER ZUGEHÖRIGEN BAND
Für andere als die in Betracht gezogenen Lösungen wenden Sie sich an unser technisches Büro, um Informationen zu Machbarkeit und Preisen zu erhalten.

ATTENTION:

CALCULATE THE SQM OF THE ARTIKEL TO ESTABLISH THE BELONGING LEVEL.
For information on feasibility and prices of other solutions, please get in touch with our technical dept.

ATTENTION:

CALCULER LES M². DE LA PAROI POUR ÉTABLIR LA TRANCHE D'APPARTENANCE
Pour d'autres solutions que celles envisagées, contactez notre bureau technique pour connaître la faisabilité et les tarifs.

DETTAGLI & CARATTERISTICHE



BRACCIO
ARM - ARM - BARRE DE RENFORT



PROFILO INFERIORE
BOTTOM PROFILE - UNTERES PROFIL - PROFILÉ INFÉRIEUR

8 mm
OPEN SPACE

CARATTERISTICHE GENERALI

- Cristallo temperato da 8 mm.
- Finitura trasparente e grey.
- Profili in alluminio cromo lucido, nero satinato, bianco satinato e acciaio spazzolato.
- Trattamento anticalcare.

GENERAL CHARACTERISTICS

- 8 mm tempered safety crystal.
- Crystal finishing: transparent and grey.
- Profiles made of chrome aluminium, brushed stainless steel and matt black or white.
- Descaling.

TECHNISCHE MERKMALE

- Sekurirkristallglas 8 mm stark.
- Kristallfinish: Transparent und Grau.
- Poliert-Chrom-, schwarz-weiß-satiniert- und Gebürstet-rostfreie Profile.
- Entkalkungsbehandlung.

SPECIFICATIONS GENERALES

- Verre trempé 8 mm.
- Finition du verre: transparent et fumé.
- Profils et barres de renfort en aluminium chromé, noir satiné, blanc satiné et acier brossé.
- Traitement anticalcare.



6
mm
OPEN SPACE



TREMITI WALL

CRISTALLO TRASPARENTE
 TRANSPARENT CRYSTAL
 TRANSPARENTES KRISTALLGLAS
 VERRE TRANSPARENT

| CODICE Code - Artikel - Article | Formato (cm) Size - Format - Dimension | Estensibilità Extensibility - Streckbarkeit - Extensibilité | Prezzo unitario Price - Preis - Prix |
|---|--|---|--|
| LTWI 1006 | 100 | 98 ÷ 99 | 422,00 |
| LTWI 1106 | 110 | 108 ÷ 109 | 449,00 |
| LTWI 1206 | 120 | 118 ÷ 119 | 472,00 |
| LTWI 1306 | 130 | 128 ÷ 129 | 501,00 |
| LTWI 1406 | 140 | 138 ÷ 139 | 531,00 |
| LTWI 1506 | 150 | 148 ÷ 149 | 559,00 |
| LTWI 1706 | 170 | 168 ÷ 169 | 615,00 |

Braccio di sostegno pieghevole lunghezza massima 100 cm. tagliabile.

Foldable and cuttable support arm 100 cm maximum.
 Verstellbarer, schneidbarer Tragarm maximum 100 cm.
 Barre de renfort de 100 cm de longueur découplable.

6 mm
OPEN SPACE

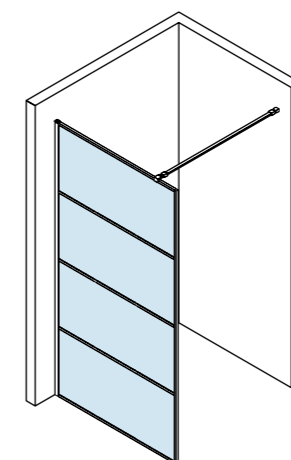
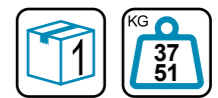
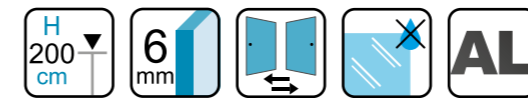

PROFILO A MURO
 WALL PROFILE - WANDPROFIL - PROFIL DE MUR

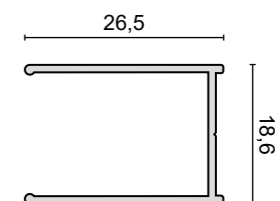

TRATTAMENTO ANTICALCARE

Descaling
 Entkalkungsbehandlung
 Traitement anticalcaire



TREMITI WALL MATT

CRISTALLO SATINATO
MATT CRYSTAL
SATINIERTES KRISTALLGLAS
VERRE MAT

| CODICE <i>Code - Artikel - Article</i> | Formato (cm) <i>Size - Format - Dimension</i> | Estensibilità <i>Extensibility - Streckbarkeit - Extensibilité</i> | Prezzo unitario <i>Price - Preis - Prix</i> |
|---|--|---|--|
| LTWI 1006M | 100 | 98 ÷ 99 | 494,00 |
| LTWI 1106M | 110 | 108 ÷ 109 | 530,00 |
| LTWI 1206M | 120 | 118 ÷ 119 | 562,00 |
| LTWI 1306M | 130 | 128 ÷ 129 | 601,00 |
| LTWI 1406M | 140 | 138 ÷ 139 | 637,00 |
| LTWI 1506M | 150 | 148 ÷ 149 | 671,00 |
| LTWI 1706M | 170 | 168 ÷ 169 | 742,00 |

Braccio di sostegno pieghevole lunghezza massima 100 cm. tagliabile.

*Foldable and cuttable support arm 100 cm maximum.
Verstellbarer, schneidbarer Tragarm maximum 100 cm.
Barre de renfort de 100 cm de longueur découpable.*

6 mm
OPEN SPACE

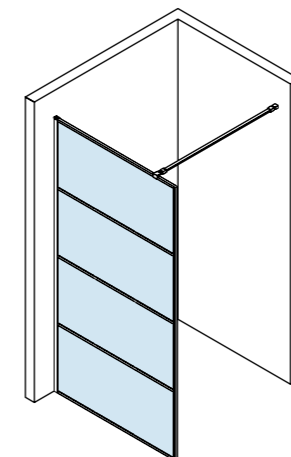
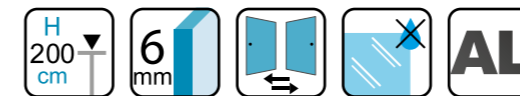

PROFILO A MURO
WALL PROFILE - WANDPROFIL - PROFIL DE MUR

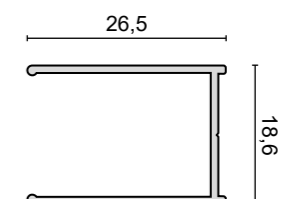

TRATTAMENTO
ANTICALCARE

Descaling
Entkalkungsbehandlung
Traitement anticalcaire

TREMITI WALL

LACUS RIVESTE... SU MISURA - LACUS MAKES IT... TO MEASURE - LACUS FERTIG ...MASSGERECHT - LACUS UNE FABRICATION SUR ...MESURE

Articoli speciali su ordinazione - Special Items on request - Sonderanfertigungen auf Bestellung - Articles 'à la carte' sur commande

OPEN SPACE

NON DISPONIBILE
UNAVAILABLE
NICHT VERFÜGBAR
PAS DISPONIBLE

NON DISPONIBILE
UNAVAILABLE
NICHT VERFÜGBAR
PAS DISPONIBLE

NON DISPONIBILE
UNAVAILABLE
NICHT VERFÜGBAR
PAS DISPONIBLE

DETTAGLI & CARATTERISTICHE



BRACCIO SNODABILE - ADJUSTABLE ARM
VERSTELLBARER ARM - BARRE DE RENFORT ARTICULÉE



PROFILI - PROFILE - PROFIL - PROFILÉ

6 mm
OPEN SPACE

CARATTERISTICHE OPEN SPACE

- Cristallo temperato 6 mm.
- Finitura trasparente e matt.
- Profili in alluminio nero satinato.

GENERAL FEATURES OF OPEN SPACE

- 6 mm tempered safety crystal.
- Crystal finishing: transparent and matt.
- Matt black aluminium profiles.

ALLGEMEINE SPEZIFIKATIONEN DER DUSCH-KABINEN

- Sekurirkristallglas 6 mm stark.
- Kristallfinish: Transparent und Matt.
- Schwarz-satinierte Aluminiumprofile.

SPECIFICATIONS GENERALES DES CABINES

- Verre trempé 6 mm.
- Finition du verre: transparent et mat.
- Profilés et barres de renfort en aluminium noir satiné.

ALICUDI WALL 6 MM

CRISTALLO TRASPARENTE
 TRANSPARENT CRYSTAL
 TRANSPARENTES KRISTALLGLAS
 VERRE TRANSPARENT

| CODICE <i>Code - Artikel - Article</i> | Formato (cm) <i>Size - Format - Dimension</i> | Estensibilità <i>Extensibility - Streckbarkeit - Extensibilité</i> | Prezzo unitario <i>Price - Preis - Prix</i> |
|--|---|--|---|
| LWI 906 | 90 x 200 | 88,5 ÷ 90 | 371,00 |
| LWI 1006 | 100 x 200 | 98,5 ÷ 100 | 393,00 |
| LWI 1106 | 110 x 200 | 108,5 ÷ 110 | 416,00 |
| LWI 1206 | 120 x 200 | 118,5 ÷ 120 | 438,00 |
| LWI 1306 | 130 x 200 | 128,5 ÷ 130 | 469,00 |
| LWI 1406 | 140 x 200 | 138,5 ÷ 140 | 471,00 |
| LWI 1506 | 150 x 200 | 148,5 ÷ 150 | 506,00 |
| LWI 1606 | 160 x 200 | 158,5 ÷ 160 | 546,00 |
| LWI 1706 | 170 x 200 | 168,5 ÷ 170 | 550,00 |

Estensibilità del braccio cromo da 65 fino a 120 cm. - *Adjustment chrome arm from 65 to 120 cm.*
Streckbarkeit der verchromten Wandstange von 65 bis 120 cm. - Extensibilité de la barre de renfort chromée de 65 à 120 cm.



6
mm
OPEN SPACE







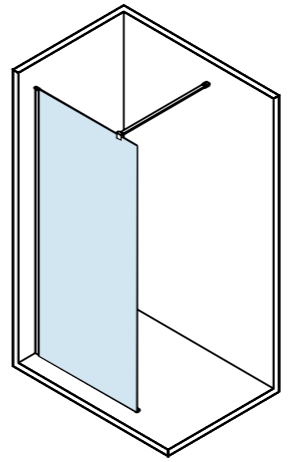

PROFILO A MURO
 WALL PROFILE - WANDPROFIL - PROFIL DE MUR

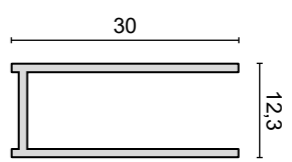

ALICUDI WALL

LACUS RIVESTE... SU MISURA - LACUS MAKES IT... TO MEASURE - LACUS FERTIG ...MASSGERECHT - LACUS UNE FABRICATION SUR ...MESURE

Articoli speciali su ordinazione - Special Items on request - Sonderanfertigungen auf Bestellung - Articles 'à la carte' sur commande

OPEN SPACE

Altezza **max 200 cm.** - Larghezza **max 180 cm.**
 Height **max 200 cm.** - Width **max 180 cm.**
 Maximale Höhe **200 cm.** - Maximale Breite **180 cm.**
 Hauteur **200 cm. maximum** - Largeur **180 cm. maximum**



PREZZO DI LISTINO AL PEZZO (TRASPARENTE)

GROSS PREIS PRO PIECE (TRANSPARENT)
 LISTENPREIS PRO STÜCK (TRANSPARENT)
 PRIX TARIF PAR PIÈCE (TRANSPARENT)

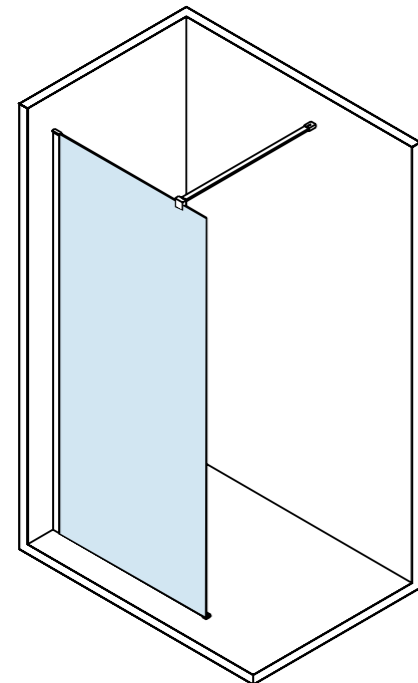

| | |
|---|-------------------|
| FASCIA 1: da 1,01 a 1,50 mq Level 1: from 1.01 to 1.5 sqm | € 608,00 |
| FASCIA 2: da 1,51 a 2,00 mq Level 2: from 1.51 to 2.0 sqm | € 687,00 |
| FASCIA 3: da 2,01 a 2,50 mq Level 3: from 2.01 to 2.5 sqm | € 772,00 |
| FASCIA 4: da 2,51 a 3,00 mq Level 4: from 2.51 to 3.0 sqm | € 874,00 |
| FASCIA 5: da 3,01 a 3,50 mq Level 5: from 3.01 to 3.5 sqm | € 978,00 |
| FASCIA 6: da 3,51 a 4,00 mq Level 6: from 3.51 to 4.0 sqm | € 1.057,00 |

Maggiorazione per vetro Matt, Fox e Grey: +15%

Surcharge for matt, fox and grey crystal + 15% - Aufpreis für Matt, Fox und Grey Kristallglas +15% - Majoration pour les verres Matt, Fox et Grey: +15%

ATTENZIONE:

CALCOLARE I MQ. DEL PEZZO PER STABILIRE LA FASCIA DI APPARTENENZA
 Per soluzioni diverse da quelle contemplate contattare ns. ufficio tecnico per avere indicazioni di fattibilità e prezzi.

VORSICHT:

BERECHNEN DIE QM. DES STÜCKES, ZUR ERFÜLLUNG DER ZUGEHÖRIGEN BAND
 Für andere als die in Betracht gezogenen Lösungen wenden Sie sich an unser technisches Büro, um Informationen zu Machbarkeit und Preisen zu erhalten.

ATTENTION:

CALCULATE THE SQM OF THE ARTIKEL TO ESTABLISH THE BELONGING LEVEL.
 For information on feasibility and prices of other solutions, please get in touch with our technical dept.

ATTENTION:

CALCULER LES M². DE LA PAROI POUR ÉTABLIR LA TRANCHE D'APPARTENANCE
 Pour d'autres solutions que celles envisagées, contactez notre bureau technique pour connaître la faisabilité et les tarifs.

DETTAGLI & CARATTERISTICHE

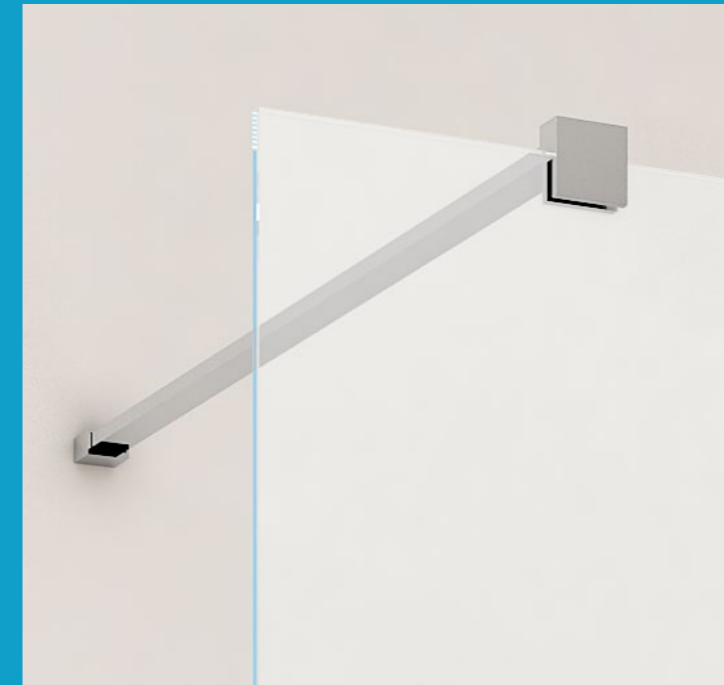

BRACCIO DI SOSTEGNO
 ARM - ARM - BARRE DE RENFORT



PROFILO INFERIORE
 BOTTOM PROFILE - UNTERES PROFIL - PROFILÉ

6 mm
 OPEN SPACE

CARATTERISTICHE OPEN SPACE

- Cristallo temperato 6 mm.
- Finitura trasparente.
- Profili in alluminio cromo lucido.

GENERAL FEATURES OF OPEN SPACE

- 6 mm tempered safety crystal.
- Crystal finishing: transparent.
- Profiles made of chrome aluminium.

ALLGEMEINE SPEZIFIKATIONEN DER DUSCH-KABINEN

- Sekuritkristallglas 6 mm stark.
- Kristallfinish: transparent.
- Verchromte Aluminiumprofile.

SPECIFICATIONS GENERALES DES CABINES

- Verre trempé 6 mm.
- Finition du verre: transparent.
- Profilés et barres de renfort en aluminium chromé.

TRATTAMENTO ANTICALCARE

Descaling
Entkalkungsbehandlung
Traitement anticalcaire

SALINA

CRISTALLO TRASPARENTE
TRANSPARENT CRYSTAL
TRANSPARENTES KRISTALLGLAS
VERRE TRANSPARENT

| CODICE Code - Artikel - Article | Formato (cm) Size - Format - Dimension | Lato fisso + Anta Size - Format - Dimension | Estensibilità Extensibility - Streckbarkeit - Extensibilité | Prezzo (€) Price - Preis - Prix |
|---|--|---|---|---|
| LOSA P 100 | 100 | 60 + 40 | 98 ÷ 99,5 | 660,00 |
| LOSA P 120 | 120 | 80 + 40 | 118 ÷ 119,5 | 702,00 |
| LOSA P 130 | 130 | 90 + 40 | 128 ÷ 129,5 | 720,00 |
| LOSA P 140 | 140 | 100 + 40 | 138 ÷ 139,5 | 804,00 |
| LOSA P 150 | 150 | 110 + 40 | 148 ÷ 149,5 | 829,00 |
| LOSA P 160 | 160 | 120 + 40 | 158 ÷ 159,5 | 856,00 |

Estensibilità del braccio cromo da 65,0 fino a 120,0 cm. - Adjustment chrome arm from 65,0 to 120,0 cm. -
Streckbarkeit der verchromten Wandstange von 65,0 bis 120,0 cm. - Extensibilité de la barre de renfort chromée de 65 à 120 cm.
Il formato comprende sia la parete fissa che basculante - The size includes both the fixed and the pivoting panel -
Das Format enthält sowohl die feste als auch die drehbare Seite - Le format correspond à la paroi fixe et au volet mobile.

Profilo maggiore estensibilità

Wall profile adjustment - Verlängerungsprofil - Profilé pour extension supplémentaire

| Codice - Code Artikel - Article | Formato (cm) - Size Format - Dimension | + cm. | Prezzo (€) - Price Preis - Prix |
|---|--|--------------|---|
| MTP 04 | 4,2 x 200 | 1,5 | 80,00 |

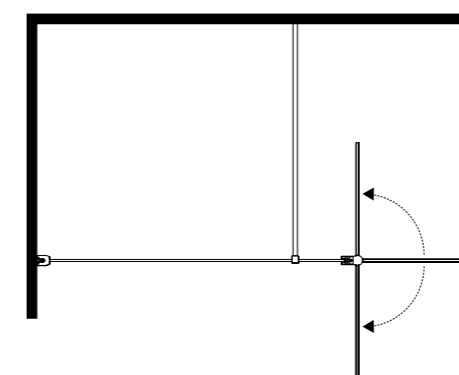
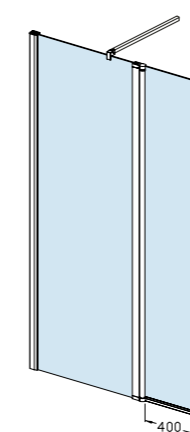
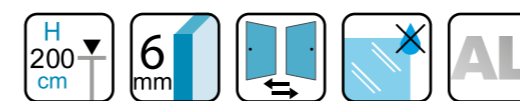

PROFILO A MURO
WALL PROFILE - WANDPROFIL - PROFIL DE MUR

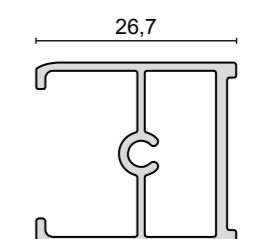

SALINA

LACUS RIVESTE... SU MISURA - LACUS MAKES IT... TO MEASURE - LACUS FERTIG ...MASSGERECHT - LACUS UNE FABRICATION SUR ...MESURE

Articoli speciali su ordinazione - Special Items on request - Sonderanfertigungen auf Bestellung - Articles 'à la carte' sur commande

OPEN SPACE

Altezza **max 200 cm.** - Larghezza **max 200 cm.**
 Height **max 200 cm.** - Width **max 200 cm.**
 Maximale Höhe **200 cm.** - Maximale Breite **200 cm.**
 Hauteur **200 cm. maximum** - Largeur **200 cm. maximum**



PREVENTIVO SU RICHIESTA

PRICE ON REQUEST
 ANGEBOT AUF ANFRAGE
 DEVIS SUR DEMANDE

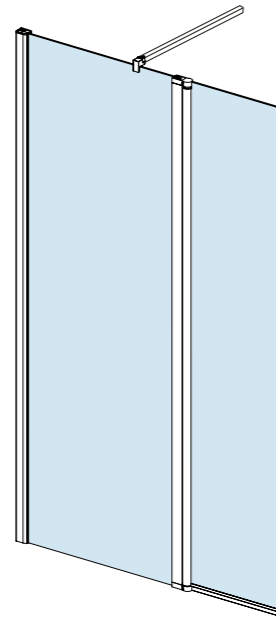

DETTAGLI & CARATTERISTICHE



PIVOT INFERIORE - PIVOTING PANEL - DREHBARESEITE - VOLET MOBILE

6
mm
OPEN SPACE

Per soluzioni diverse da quelle contemplate contattare ns. ufficio tecnico per avere indicazioni di fattibilità e prezzi.

For information on feasibility and prices of other solutions, please get in touch with our technical dept.

Für andere als die in Betracht gezogenen Lösungen wenden Sie sich an unser technisches Büro, um Informationen zu Machbarkeit und Preisen zu erhalten.

Pour des solutions autres que celles envisagées, contactez notre bureau technique pour connaître la faisabilité et les tarifs.

CARATTERISTICHE OPEN SPACE

- Cristallo temperato 6 mm.
- Finitura trasparente.
- Profili in alluminio cromo lucido.

GENERAL FEATURES OF OPEN SPACE

- 6 mm tempered safety crystal.
- Crystal finishing: transparent.
- Profiles made of chrome aluminium.

ALLGEMEINE SPEZIFIKATIONEN DER DUSCH-KABINEN

- Sekurirkristallglas 6 mm stark.
- Kristallfinish: transparent.
- Verchromte Aluminiumprofile.

SPECIFICATIONS GENERALES DES CABINES

- Verre trempé 6 mm.
- Finition du verre: transparent.
- Profilés et barres de renfort en aluminium chromé.

TRATTAMENTO ANTICALCARE

Descaling
Entkalkungsbehandlung
Traitement anticalcaire

LEVANZO

CRISTALLO TRASPARENTE
TRANSPARENT CRYSTAL
TRANSPARENTES KRISTALLGLAS
VERRE TRANSPARENT

| CODICE Code - Artikel - Article | Formato (cm) Size - Format - Dimension | Estensibilità Extensibility - Streckbarkeit - Extensibilité | Prezzo (€) Price - Preis - Prix |
|---|--|---|---|
| LSVS 12026 | 120 X 150 | 65,5 ÷ 114 | 647,00 |

Apertura ante 180° - Opening doors 180° - Öffnung 180° - Ouverture 180°

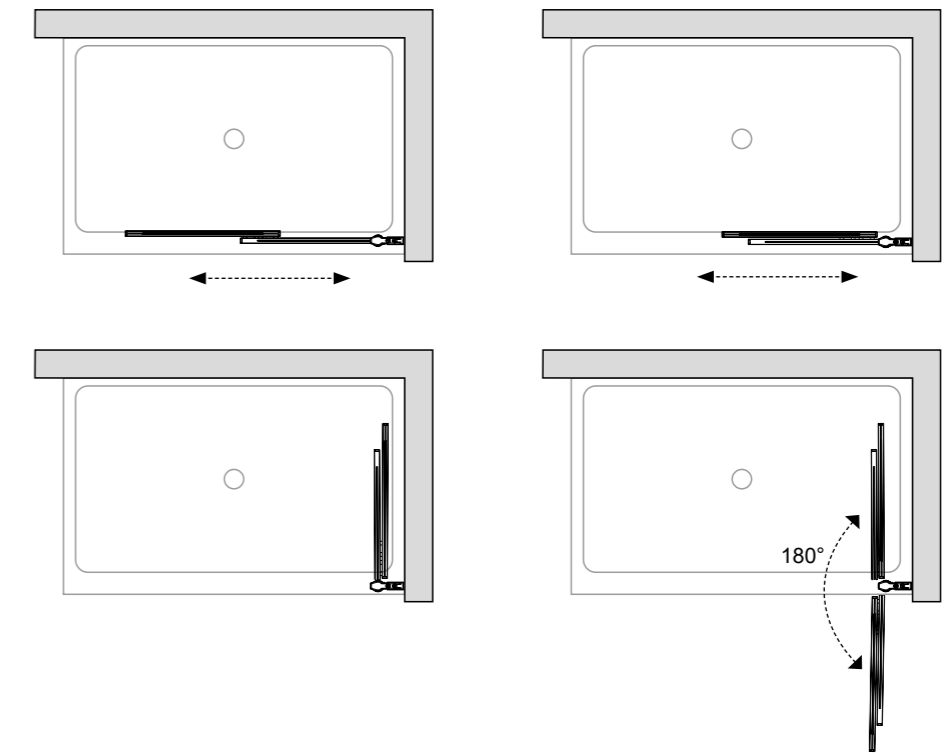

6 mm
OPEN SPACE

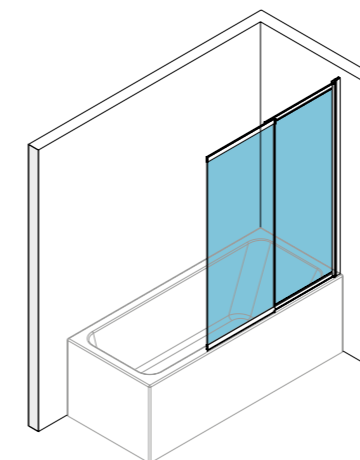
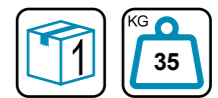

PROFILO A MURO
WALL PROFILE - WANDPROFIL - PROFIL DE MUR

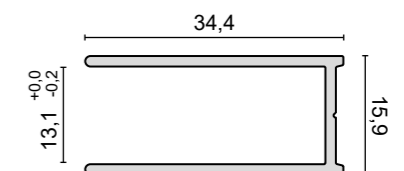



MARETTIMO EVO

CRISTALLO TRASPARENTE
 TRANSPARENT CRYSTAL
 TRANSPARENTES KRISTALLGLAS
 VERRE TRANSPARENT

| CODICE Code - Artikel - Article | Formato (cm) Size - Format - Dimension | Estensibilità Extensibility - Streckbarkeit - Extensibilité | Prezzo (€) Price - Preis - Prix |
|---|--|---|---|
| LSV E 12026 | 120 X 150 | 118,5 ÷ 120 | 606,00 |

Apertura ante 180° - Opening doors 180° - Öffnung 180° - Ouverture 180°

6 mm
OPEN SPACE

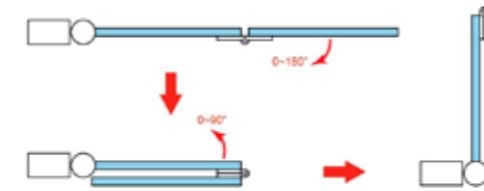
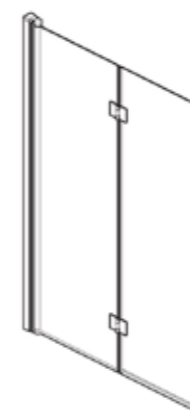
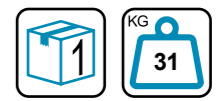

PROFILO A MURO
 WALL PROFILE - WANDPROFIL - PROFIL DE MUR

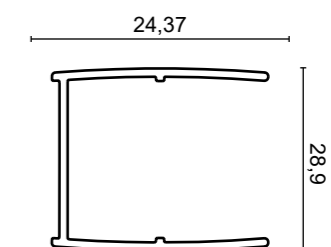

FAVIGNANA EVO

CRISTALLO TRASPARENTE
 TRANSPARENT CRYSTAL
 TRANSPARENTES KRISTALLGLAS
 VERRE TRANSPARENT

| CODICE <i>Code - Artikel - Article</i> | Formato (cm) <i>Size - Format - Dimension</i> | Estensibilità <i>Extensibility - Streckbarkeit - Extensibilité</i> | Prezzo (€) <i>Price - Preis - Prix</i> |
|--|---|--|--|
| LSV EVO 8016 | 80 X 150 | 78 ÷ 80 | 327,00 |

Apertura ante 180° - Opening doors 180° - Öffnung 180° - Ouverture 180°



6 mm
OPEN SPACE

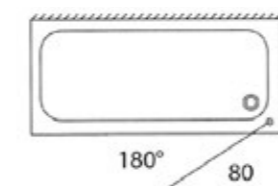
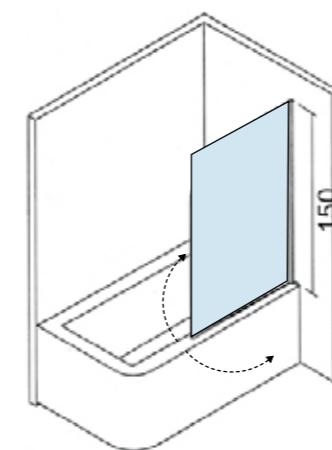
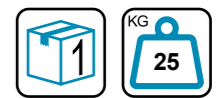

PROFILO A MURO
 WALL PROFILE - WANDPROFIL - PROFIL DE MUR

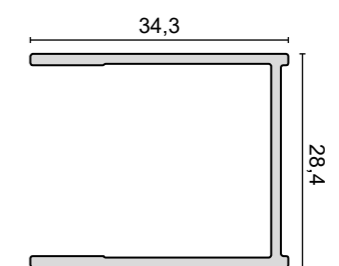

FAVIGNANA / MARETTIMO / LEVANZO

LACUS RIVESTE... SU MISURA - LACUS MAKES IT... TO MEASURE - LACUS FERTIG ...MASSGERECHT - LACUS UNE FABRICATION SUR ...MESURE

Articoli speciali su ordinazione - Special Items on request - Sonderanfertigungen auf Bestellung - Articles 'à la carte' sur commande

FAVIGNANA

Altezza max 190 cm. - Larghezza max 100 cm.
Height max 190 cm. - Width max 100 cm.
Maximale Höhe 190 cm. - Maximale Breite 100 cm.
Hauteur 190 cm. maximum - Largeur 100 cm. maximum



MARETTIMO EVO

Altezza max 150 cm. - Larghezza max 120 cm.
Height max 150 cm. - Width max 120 cm.
Maximale Höhe 150 cm. - Maximale Breite 120 cm.
Hauteur 150 cm. maximum - Largeur 120 cm. maximum



PREZZO DI LISTINO AL PEZZO (TRASPARENTE)

GROSS PREIS PRO PIECE (TRANSPARENT)
LISTENPREIS PRO STÜCK (TRANSPARENT)
PRIX TARIF PAR PIÈCE (TRANSPARENT)

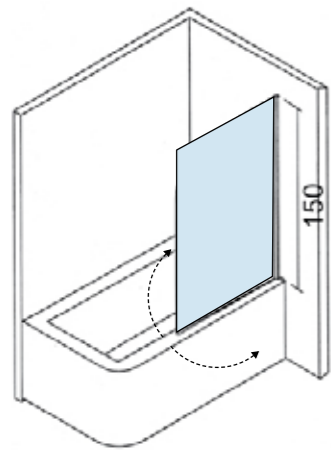

FASCIA 1:
da 0,01 a 0,50 mq
Level 1:
from 0.01 to 0.5 sqm

€ 670,00

FASCIA 2:
da 0,51 a 1,00 mq
Level 2:
from 0.51 to 1.0 sqm

€ 747,00

FASCIA 3:
da 1,01 a 1,50 mq
Level 3:
from 1.01 to 1.5 sqm

€ 839,00

FASCIA 4:
da 1,51 a 2,00 mq
Level 4:
from 1.51 to 2.0 sqm

€ 918,00

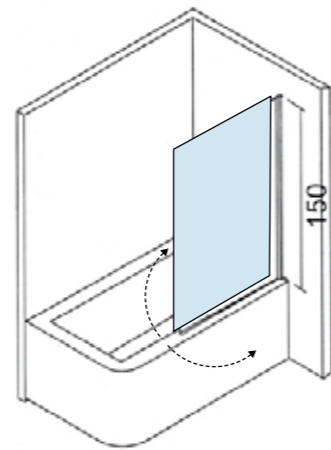

Maggiorazione per vetro Matt, Fox e Gray: +15%
Surcharge for matt, fox and grey crystal + 15%
Aufpreis für Matt, Fox und Grey Kristallglas +15%
Majoration pour les verres Matt, Fox et Grey: +15%

ATTENZIONE:

CALCOLARE I MQ. DEL PEZZO PER STABILIRE LA FASCIA DI APPARTENENZA
Per soluzioni diverse da quelle contemplate contattare ns. ufficio tecnico per avere indicazioni di fattibilità e prezzi.

VORSICHT:

BERECHNEN DIE QM. DES STÜCKES, ZUR ERFÜLLUNG DER ZUGEHÖRIGEN BAND
Für andere als die in Betracht gezogenen Lösungen wenden Sie sich an unser technisches Büro, um Informationen zu Machbarkeit und Preisen zu erhalten.

ATTENTION:

CALCULATE THE SQM OF THE ARTIKEL TO ESTABLISH THE BELONGING LEVEL.
For information on feasibility and prices of other solutions, please get in touch with our technical dept.

ATTENTION:

CALCULER LES M². DE LA PAROI POUR ÉTABLIR LA TRANCHE D'APPARTENANCE
Pour d'autres solutions que celles envisagées, contactez notre bureau technique pour connaître la faisabilité et les tarifs.



SOPRA VASCA SCORREVOLE E GIREVOLE 2 ANTE 180°
180° Bath screen 2 doors both sliding and pivot
180° drehbare Badenwannen Duschwand mit 2 Scheibeseiten
Pare-baignoire 2 volets coulissant pivotant 180°

6
mm
OPEN SPACE

CARATTERISTICHE GENERALI

- I piatti doccia Marfil sono realizzati in polvere di marmo, carbonato di calcio, quarzo e resina.
- Il corpo del piatto è colorato in pasta.
- Spessore 3 cm.
- Piletta di scarico e copripiletta in dotazione (36 L/Min).
- Superficie strutturata e antiscivolo.
- Possibilità di taglio.
- Disponibile Kit di riparazione colore.

GENERAL CHARACTERISTICS

- The shower trays Marfil are made of marble powder, calcium carbonate, quartz and resin.
- The body of the shower tray is colored.
- Thickness of 3 cm.
- Drain and drain cover included (36 liter/minute).
- Antislip texture.
- Possible to cut.
- Available colour repair kit.

ALLGEMEINE EIGENSCHAFTEN

- Aus Marmorpulver, Kalziumkarbonat, Quarz und Harz hergestellt.
- Der Körper der Duschtassen ist farbig.
- Stärke 3 cm.
- Ab- und Überlaufgarnitur im Preis inbegriffen (36 L/Minute).
- Rutschfeste strukturierte Oberfläche.
- Kürzbar
- Reparaturkit der Farbe vorhanden

SPECIFICATIONS GENERALES

- Les receveurs sont fabriqués en poudre de marbre, carbonate de calcium, quartz et résine.
- Ils sont colorés dans la masse.
- Épaisseur 3 cm.
- Bonde (436 l/min) et grille d'évacuation incluses.
- Texture antidérapante.
- Découpable.
- Kit correction de couleur disponible.



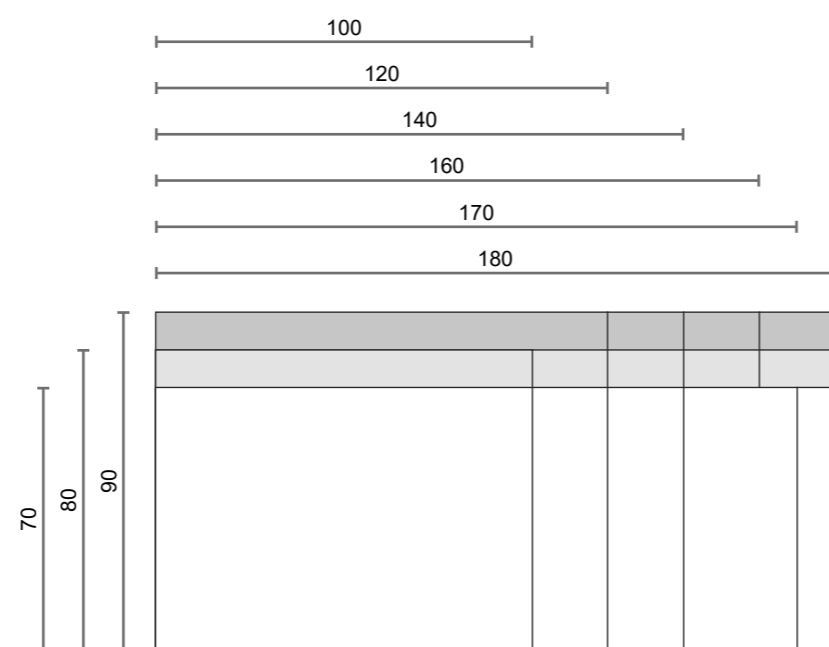

| CODICE <i>Code - Artikel - Article</i> | Formato (cm) <i>Size - Format - Dimension</i> | Spessore (cm) <i>Thickness - Stärke - Épaisseur</i> | Prezzo (€) <i>Price - Preis - Prix</i> |
|--|---|---|--|
| LPDR 3710 MB | 70 x 100 | 2,7 / 3,0 | 558,00 |
| LPDR 3720 MB | 70 x 120 | 2,7 / 3,0 | 626,00 |
| LPDR 3740 MB | 70 x 140 | 2,7 / 3,0 | 685,00 |
| LPDR 3770 MB | 70 x 170 | 2,7 / 3,0 | 784,00 |
| LPDR 3780 MB | 70 x 180 | 2,7 / 3,0 | 810,00 |
| LPDR 3810 MB | 80 x 100 | 2,7 / 3,0 | 585,00 |
| LPDR 3820 MB | 80 x 120 | 2,7 / 3,0 | 650,00 |
| LPDR 3840 MB | 80 x 140 | 2,7 / 3,0 | 718,00 |
| LPDR 3860 MB | 80 x 160 | 2,7 / 3,0 | 784,00 |
| LPDR 3880 MB | 80 x 180 | 2,7 / 3,0 | 844,00 |
| LPDR 3920 MB | 90 x 120 | 2,7 / 3,0 | 686,00 |
| LPDR 3940 MB | 90 x 140 | 2,7 / 3,0 | 755,00 |
| LPDR 3960 MB | 90 x 160 | 2,7 / 3,0 | 810,00 |
| LPDR 3980 MB | 90 x 180 | 2,7 / 3,0 | 863,00 |

E' disponibile servizio su misura con formati di larghezza da cm 70 fino a cm 90 e lunghezza da cm 90 a cm 200. Sono disponibili su richiesta colorazioni RAL. Consegna in 35/40 gg.

Personalized colours (Ral) and sizes (from 70 to 90cm wide and from 90 to 200 cm long) available. Delivery in 35/40 days. Benutzerdefinierte Farbe (RAL) und Größe (mit Breite von 70 bis 90 cm und Länge von 90 bis 200 cm) möglich. Lieferung in 35/40 Tagen. Possibilité de formats sur mesure : largeur de 70 cm à 90 cm - longueur de 90 cm à 200 cm. Possibilité de couleurs (RAL). Délai de livraison: 35/40 jours.

Disponibile Kit di riparazione colore.
Available color repair kit. Reparaturkit der gefärbten Gelcoat vorhanden. - Kit correction de couleur disponible.

Il prezzo è riferito al piatto completo di piletta e copripiletta.
Drain and drain cover included. Ab- und Überlaufgarnitur im Preis inbegriffen - Le prix correspond au receveur avec bonde et grille d'évacuation incluses.

Disegni tecnici a pag. 442 - Technical drawings on page 442 - Technische Zeichnung auf Seite 442 - Dessins techniques à la page 442.



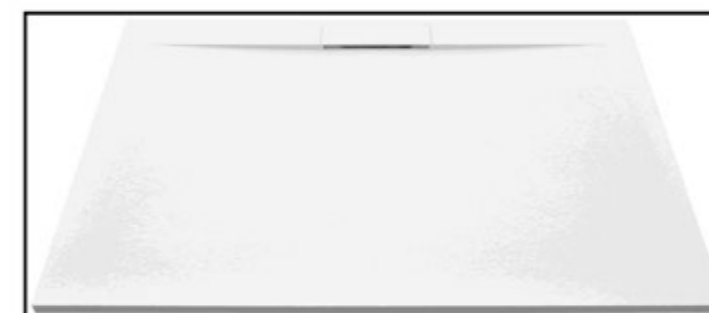
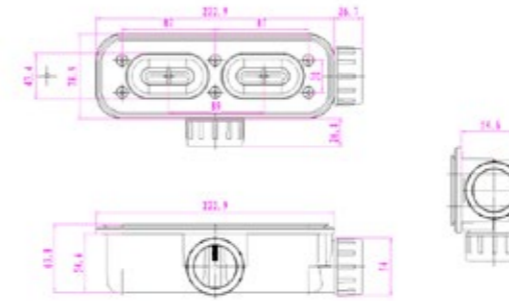
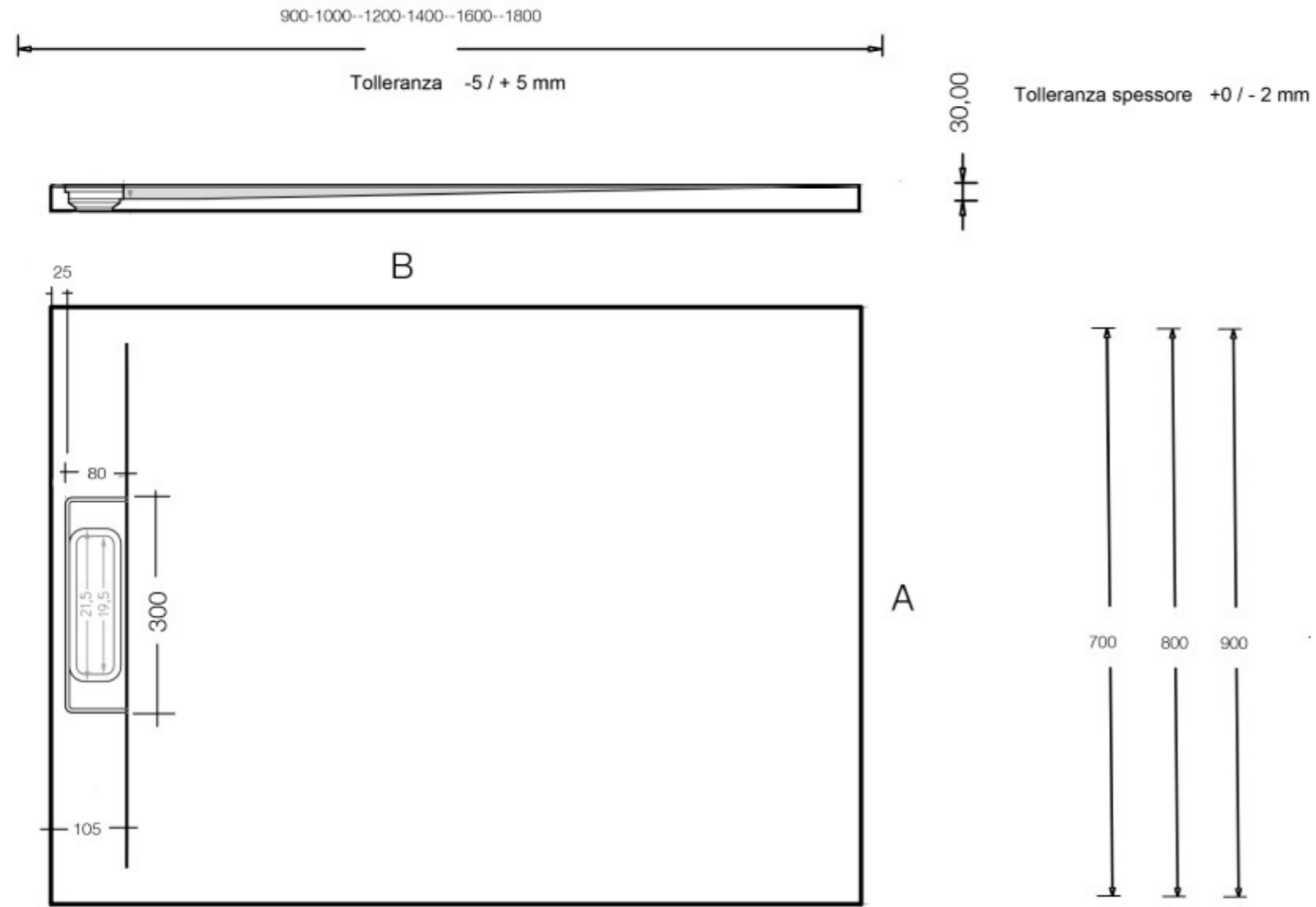

SLATE EVO

CARATTERISTICHE GENERALI

- I piatti doccia Slate Evo sono realizzati in polvere di marmo, carbonato di calcio, quarzo e resina.
- Il corpo del piatto è colorato in pasta.
- Spessore 2,7-3,0 cm.
- Piletta di scarico e copripiletta in dotazione (42 L/Min).
- Superficie strutturata e antiscivolo.
- Possibilità di taglio.
- Disponibile Kit di riparazione colore.

GENERAL CHARACTERISTICS

- The shower trays Slate Evo are made of marble powder, calcium carbonate, quartz and resin.
- The body of the shower tray is colored.
- Thickness of 2.7-3.0 cm.
- Drain and drain cover included (42 liter/minute).
- Antislip texture.
- Possible to cut.
- Available colour repair kit.

ALLGEMEINE EIGENSCHAFTEN

- Aus Marmorpulver, Kalziumkarbonat, Quarz und Harz hergestellt.
- Der Körper der Duschtassen ist farbig.
- Stärke 2,7-3,0 cm.
- Ab- und Überlaufgarnitur im Preis inbegriffen (42 L/Minute).
- Rutschfeste strukturierte Oberfläche.
- Kürzbar
- Reparaturkit der Farbe vorhanden

SPECIFICATIONS GENERALES

- Les receveurs sont fabriqués en poudre de marbre, carbonate de calcium, quartz et résine.
- Ils sont colorés dans la masse.
- Épaisseur 2,7-3,0 cm.
- Bonde (42 l/min) et grille d'évacuation incluses.
- Texture antidérapante.
- Découpable.
- Kit correction de couleur disponible.



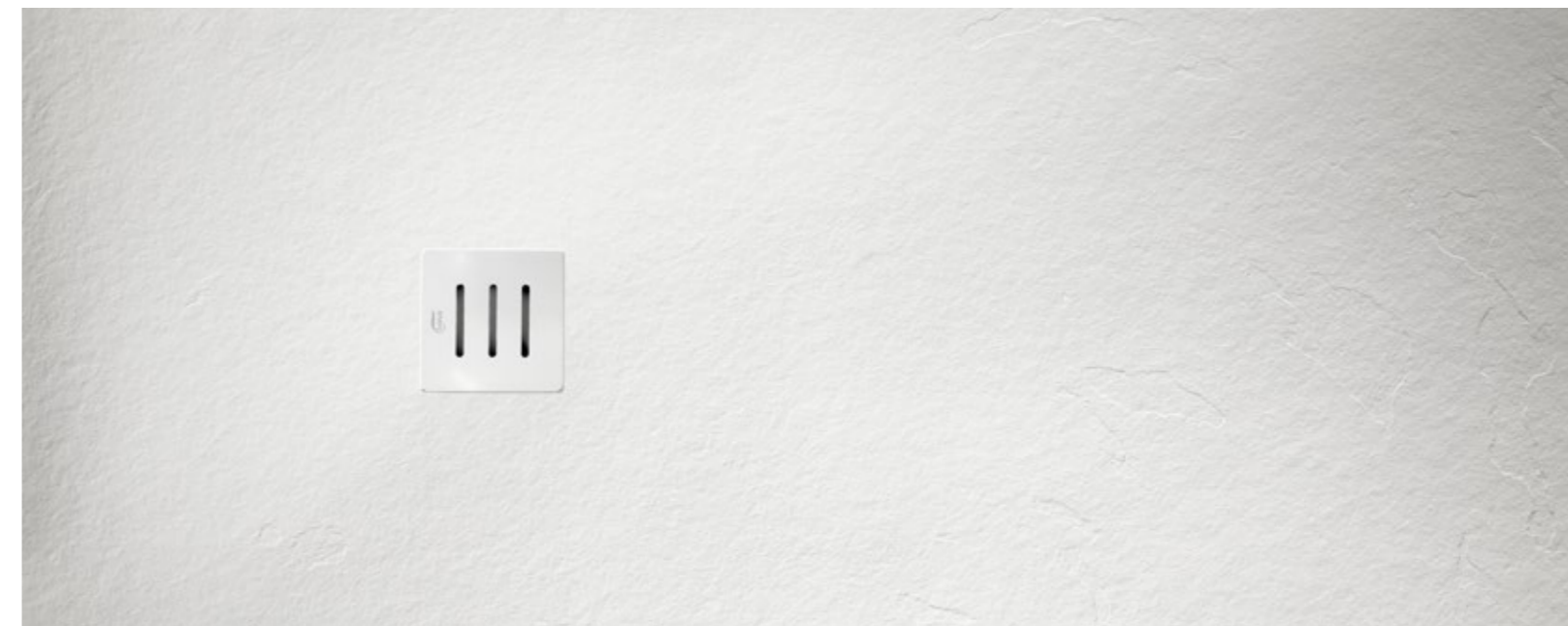

Bianco
White
Weiß
Blanc

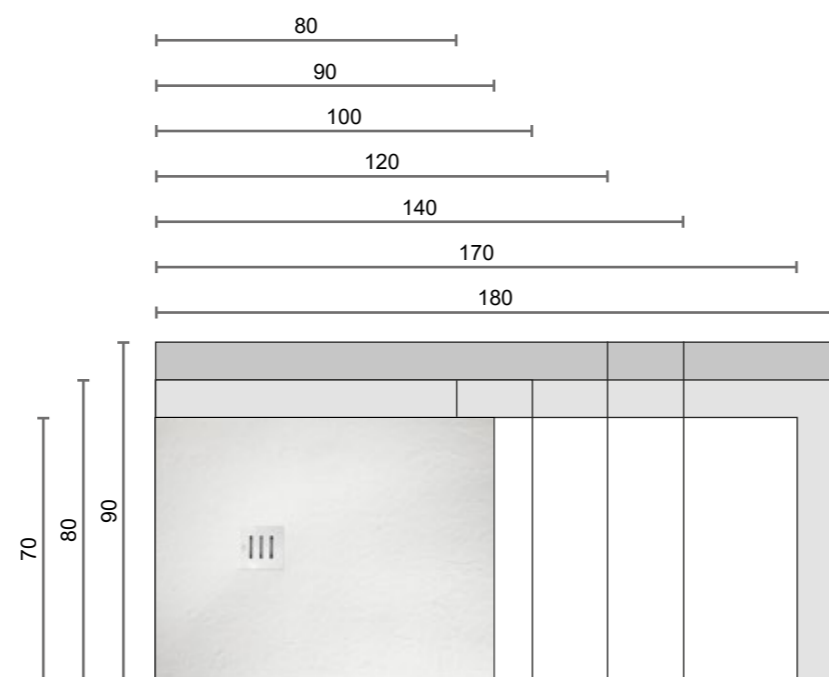

| CODICE <i>Code - Artikel - Article</i> | Formato (cm) <i>Size - Format - Dimension</i> | Spessore (cm) <i>Thickness - Stärke - Épaisseur</i> | Prezzo (€) <i>Price - Preis - Prix</i> |
|--|---|---|--|
| LPDQ 380 SEB | 80 x 80 | 2,7 / 3,0 | 474,00 |
| LPDQ 390 SEB | 90 x 90 | 2,7 / 3,0 | 538,00 |
| LPDR 379 SEB | 70 x 90 | 2,7 / 3,0 | 505,00 |
| LPDR 3710 SEB | 70 x 100 | 2,7 / 3,0 | 538,00 |
| LPDR 3720 SEB | 70 x 120 | 2,7 / 3,0 | 603,00 |
| LPDR 3740 SEB | 70 x 140 | 2,7 / 3,0 | 659,00 |
| LPDR 3770 SEB | 70 x 170 | 2,7 / 3,0 | 726,00 |
| LPDR 3810 SEB | 80 x 100 | 2,7 / 3,0 | 570,00 |
| LPDR 3820 SEB | 80 x 120 | 2,7 / 3,0 | 596,00 |
| LPDR 3840 SEB | 80 x 140 | 2,7 / 3,0 | 661,00 |
| LPDR 3860 SEB | 80 x 160 | 2,7 / 3,0 | 737,00 |
| LPDR 3870 SEB | 80 x 170 | 2,7 / 3,0 | 777,00 |
| LPDR 3880 SEB | 80 x 180 | 2,7 / 3,0 | 787,00 |
| LPDR 3920 SEB | 90 x 120 | 2,7 / 3,0 | 659,00 |
| LPDR 3940 SEB | 90 x 140 | 2,7 / 3,0 | 751,00 |
| LPDR 3980 SEB | 90 x 180 | 2,7 / 3,0 | 804,00 |

E' disponibile servizio su misura con formati di larghezza da cm 70 fino a cm 120 e lunghezza da cm 70 a cm 220. Sono disponibili su richiesta colorazioni RAL. Consegna in 35/40 gg.

Personalized colours (Ral) and sizes (from 70 to 120cm wide and from 70 to 220 cm long) available. Delivery in 35/40 days. Benutzerdefinierte Farbe (RAL) und Größe (mit Breite von 70 bis 120 cm und Länge von 70 bis 220 cm) möglich. Lieferung in 35/40 Tagen. Possibilité de couleurs (RAL) et de formats sur mesure : largeur de 70 cm à 120 cm – longueur de 70 cm à 220 cm. Délai de livraison: 35/40 jours.

Disponibile Kit di riparazione colore.
Available color repair kit. Reparaturkit der gefärbten Gelcoat vorhanden. - Kit correction de couleur disponible.

Il prezzo è riferito al piatto completo di piletta e copripiletta.
Drain and drain cover included. Ab- und Überlaufgarnitur im Preis inbegriffen - Le prix correspond au receveur avec bonde et grille d'évacuation incluses.

Disegni tecnici a pag. 458 - Technical drawings on page 458 - Technische Zeichnung auf Seite 458 - Dessins techniques à la page 458.

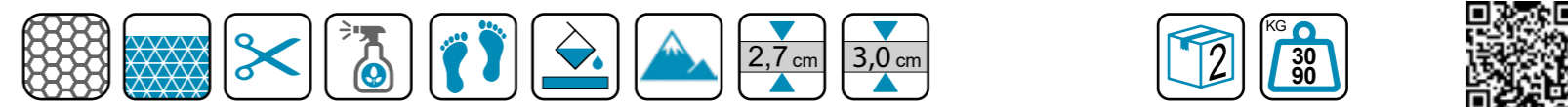



Grigio Perla
 Pearl grey
 Perlgrau
 Gris perle

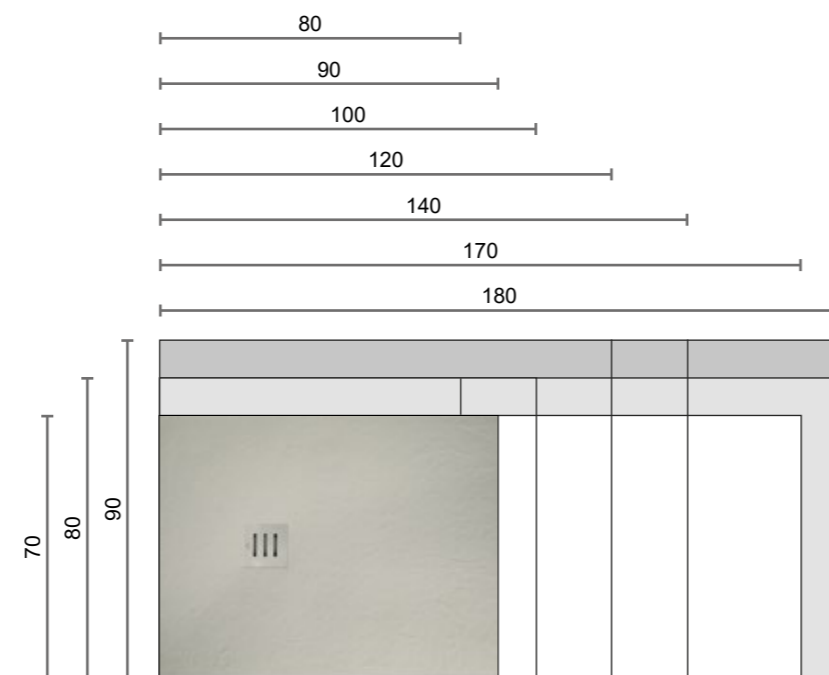

| CODICE Code - Artikel - Article | Formato (cm) Size - Format - Dimension | Spessore (cm) Thickness - Stärke - Épaisseur | Prezzo (€) Price - Preis - Prix |
|---|--|--|---|
| LPDQ 380 SEG | 80 x 80 | 2,7 / 3,0 | 474,00 |
| LPDQ 390 SEG | 90 x 90 | 2,7 / 3,0 | 538,00 |
| LPDR 379 SEG | 70 x 90 | 2,7 / 3,0 | 505,00 |
| LPDR 3710 SEG | 70 x 100 | 2,7 / 3,0 | 538,00 |
| LPDR 3720 SEG | 70 x 120 | 2,7 / 3,0 | 603,00 |
| LPDR 3740 SEG | 70 x 140 | 2,7 / 3,0 | 659,00 |
| LPDR 3770 SEG | 70 x 170 | 2,7 / 3,0 | 726,00 |
| LPDR 3810 SEG | 80 x 100 | 2,7 / 3,0 | 570,00 |
| LPDR 3820 SEG | 80 x 120 | 2,7 / 3,0 | 596,00 |
| LPDR 3840 SEG | 80 x 140 | 2,7 / 3,0 | 661,00 |
| LPDR 3860 SEG | 80 x 160 | 2,7 / 3,0 | 737,00 |
| LPDR 3870 SEG | 80 x 170 | 2,7 / 3,0 | 777,00 |
| LPDR 3880 SEG | 80 x 180 | 2,7 / 3,0 | 787,00 |
| LPDR 3920 SEG | 90 x 120 | 2,7 / 3,0 | 659,00 |
| LPDR 3940 SEG | 90 x 140 | 2,7 / 3,0 | 751,00 |
| LPDR 3980 SEG | 90 x 180 | 2,7 / 3,0 | 804,00 |

E' disponibile servizio su misura con formati di larghezza da cm 70 fino a cm 120 e lunghezza da cm 70 a cm 220. Sono disponibili su richiesta colorazioni RAL. Consegna in 35/40 gg.

*Personalized colours (Ral) and sizes (from 70 to 120cm wide and from 70 to 220 cm long) available. Delivery in 35/40 days.
 Benutzerdefinierte Farbe (RAL) und Größe (mit Breite von 70 bis 120 cm und Länge von 70 bis 220 cm) möglich. Lieferung in 35/40 Tagen.
 Possibilité de couleurs (RAL) et de formats sur mesure : largeur de 70 cm à 120 cm - longueur de 70 cm à 220 cm. Délai de livraison: 35/40 jours.*

Disponibile Kit di riparazione colore.
Available color repair kit. Reparaturkit der gefärbten Gelcoat vorhanden. - Kit correction de couleur disponible.

Il prezzo è riferito al piatto completo di piletta e copripiletta.
Drain and drain cover included. Ab- und Überlaufgarnitur im Preis inbegriffen - Le prix correspond au receveur avec bonde et grille d'évacuation incluses.

Disegni tecnici a pag. 458 - Technical drawings on page 458 - Technische Zeichnung auf Seite 458 - Dessins techniques à la page 458.

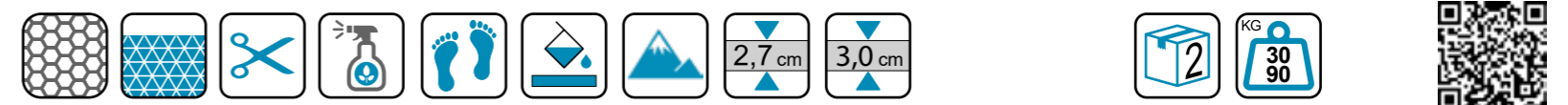

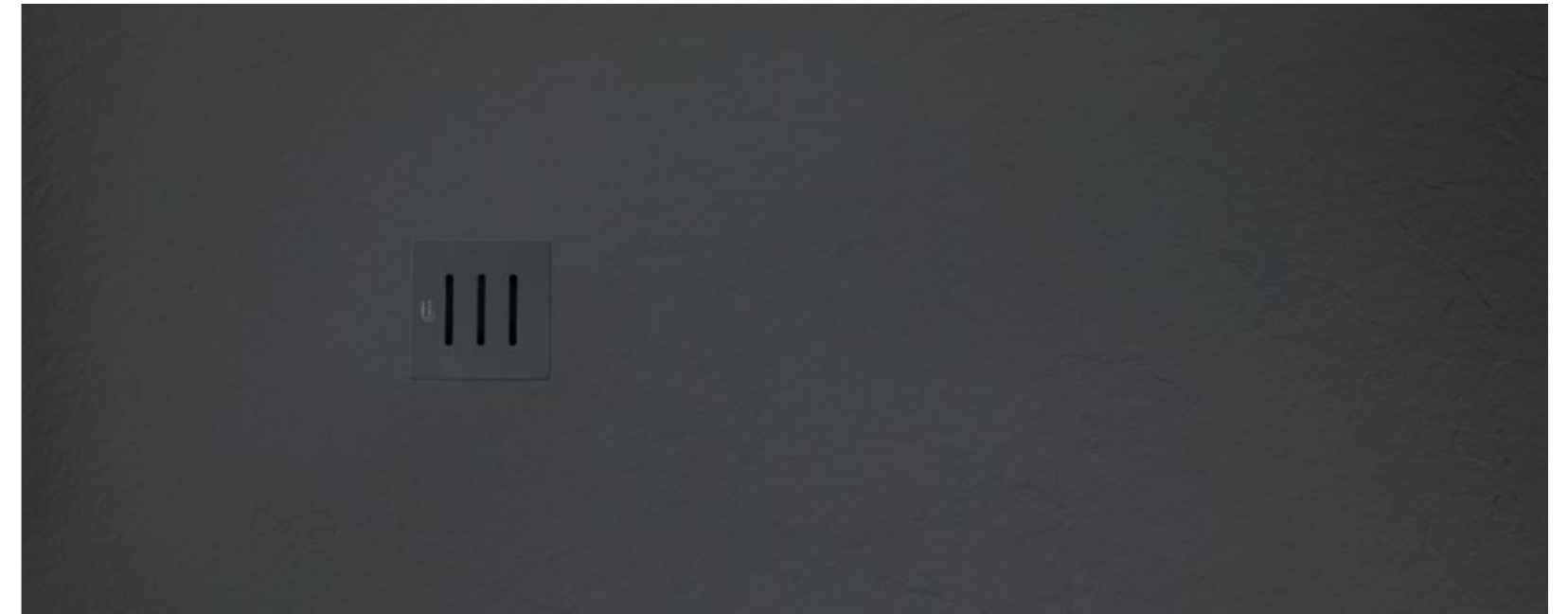
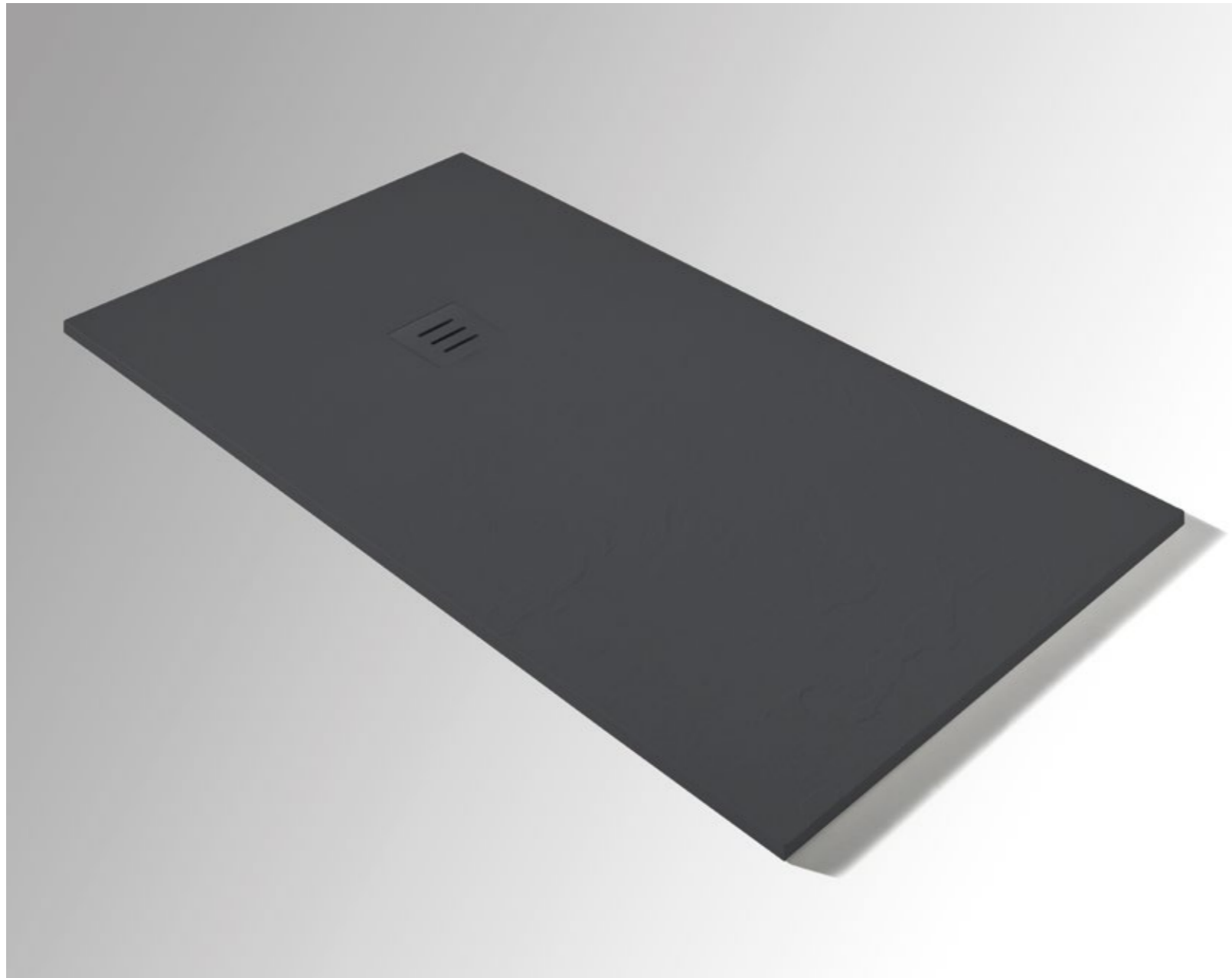

Nero
Black
Schwarz
Noir

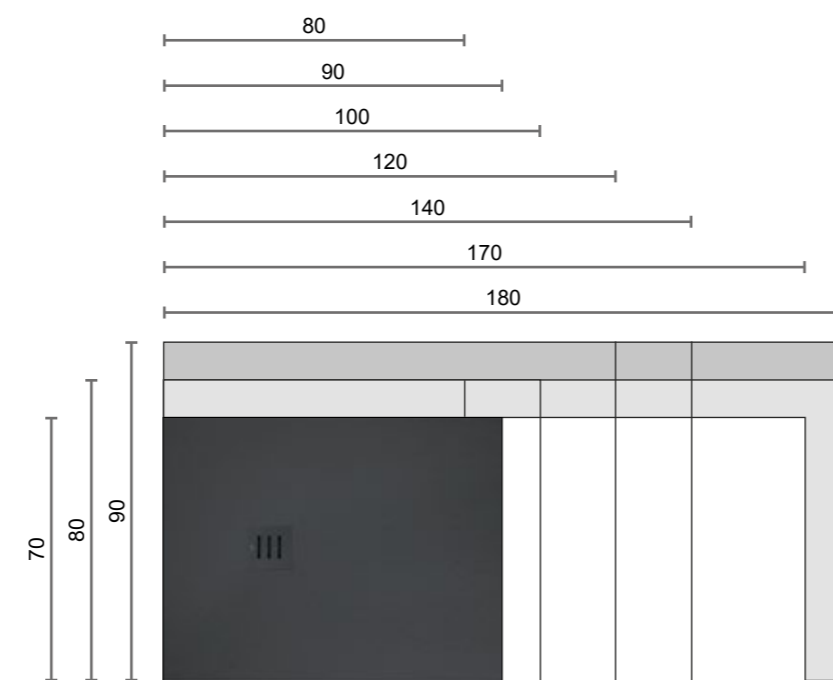

| CODICE <i>Code - Artikel - Article</i> | Formato (cm) <i>Size - Format - Dimension</i> | Spessore (cm) <i>Thickness - Stärke - Épaisseur</i> | Prezzo (€) <i>Price - Preis - Prix</i> |
|--|---|---|--|
| LPDQ 380 SEN | 80 x 80 | 2,7 / 3,0 | 474,00 |
| LPDQ 390 SEN | 90 x 90 | 2,7 / 3,0 | 538,00 |
| LPDR 379 SEN | 70 x 90 | 2,7 / 3,0 | 505,00 |
| LPDR 3710 SEN | 70 x 100 | 2,7 / 3,0 | 538,00 |
| LPDR 3720 SEN | 70 x 120 | 2,7 / 3,0 | 603,00 |
| LPDR 3740 SEN | 70 x 140 | 2,7 / 3,0 | 659,00 |
| LPDR 3770 SEN | 70 x 170 | 2,7 / 3,0 | 726,00 |
| LPDR 3810 SEN | 80 x 100 | 2,7 / 3,0 | 570,00 |
| LPDR 3820 SEN | 80 x 120 | 2,7 / 3,0 | 596,00 |
| LPDR 3840 SEN | 80 x 140 | 2,7 / 3,0 | 661,00 |
| LPDR 3860 SEN | 80 x 160 | 2,7 / 3,0 | 737,00 |
| LPDR 3870 SEN | 80 x 170 | 2,7 / 3,0 | 777,00 |
| LPDR 3880 SEN | 80 x 180 | 2,7 / 3,0 | 787,00 |
| LPDR 3920 SEN | 90 x 120 | 2,7 / 3,0 | 659,00 |
| LPDR 3940 SEN | 90 x 140 | 2,7 / 3,0 | 751,00 |
| LPDR 3980 SEN | 90 x 180 | 2,7 / 3,0 | 804,00 |

E' disponibile servizio su misura con formati di larghezza da cm 70 fino a cm 120 e lunghezza da cm 70 a cm 220. Sono disponibili su richiesta colorazioni RAL. Consegna in 35/40 gg.

Personalized colours (Ral) and sizes (from 70 to 120cm wide and from 70 to 220 cm long) available. Delivery in 35/40 days. Benutzerdefinierte Farbe (RAL) und Größe (mit Breite von 70 bis 120 cm und Länge von 70 bis 220 cm) möglich. Lieferung in 35/40 Tagen. Possibilité de couleurs (RAL) et de formats sur mesure : largeur de 70 cm à 120 cm - longueur de 70 cm à 220 cm. Délai de livraison: 35/40 jours.

Disponibile Kit di riparazione colore.
Available color repair kit. Reparaturkit der gefärbten Gelcoat vorhanden. - Kit correction de couleur disponible.

Il prezzo è riferito al piatto completo di piletta e copripiletta.
Drain and drain cover included. Ab- und Überlaufgarnitur im Preis inbegriffen - Le prix correspond au receveur avec bonde et grille d'évacuation incluses.

Disegni tecnici a pag. 458 - Technical drawings on page 458 - Technische Zeichnung auf Seite 458 - Dessins techniques à la page 458.

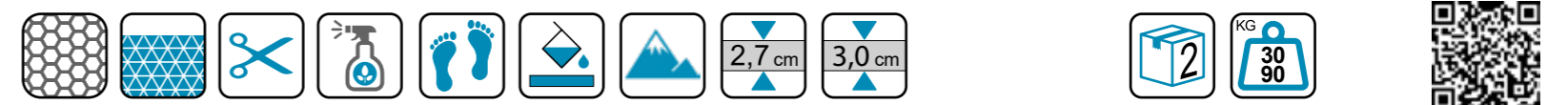

BRECCIA

CARATTERISTICHE GENERALI

- I piatti doccia Breccia sono realizzati in polvere di marmo, carbonato di calcio, quarzo e resina.
- Il corpo del piatto è colorato in pasta.
- Spessore 2,7-3,0 cm.
- Piletta di scarico e copripiletta in dotazione (42 L/Min).
- Superficie strutturata e antiscivolo.
- Possibilità di taglio.
- Disponibile Kit di riparazione colore.

GENERAL CHARACTERISTICS

- *The shower trays Breccia are made of marble powder, calcium carbonate, quartz and resin.*
- *The body of the shower tray is colored .*
- *Thickness of 2.7-3.0 cm.*
- *Drain and drain cover included (42 liter/minute).*
- *Antislip texture.*
- *Possible to cut.*
- *Available colour repair kit.*

ALLGEMEINE EIGENSCHAFTEN

- *Aus Marmorpulver, Kalziumkarbonat, Quarz und Harz hergestellt..*
- *Der Körper der Duschwanne ist farbig.*
- *Stärke 2,7-3,0 cm.*
- *Ab- und Überlaufgarnitur im Preis inbegriffen (42 L/Minute).*
- *Rutschfeste strukturierte Oberfläche.*
- *Kürzbar*
- *Reparaturkit der Farbe vorhanden*

SPECIFICATIONS GENERALES

- *Les receveurs sont fabriqués en poudre de marbre, carbonate de calcium, quartz et résine.*
- *Ils sont colorés dans la masse.*
- *Épaisseur 2,7-3,0 cm.*
- *Bonde (42 l/min) et grille d'évacuation incluses.*
- *Texture antidérapante.*
- *Découpable.*
- *Kit correction de couleur disponible.*





Bianco
White
Weiß
Blanc

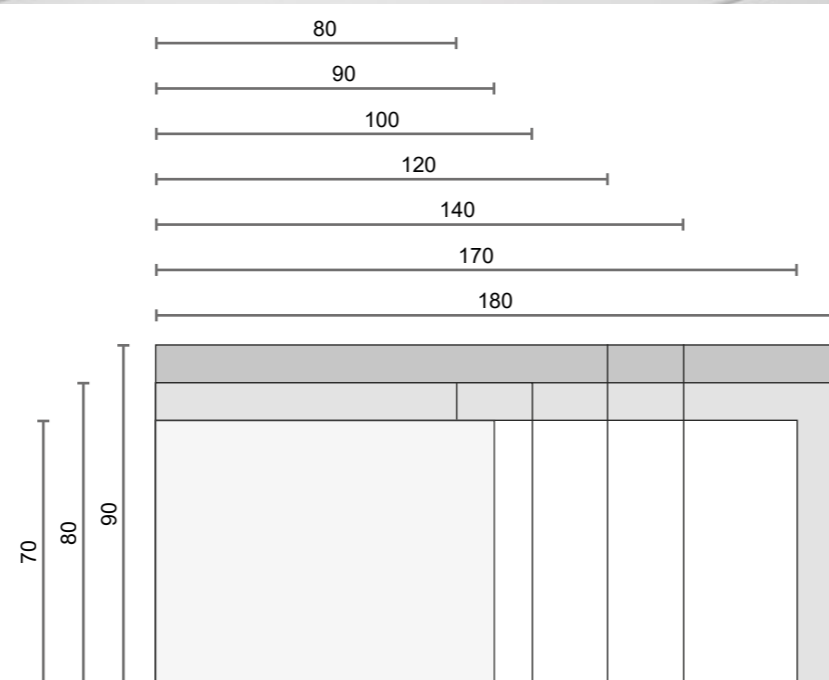

| CODICE <i>Code - Artikel - Article</i> | Formato (cm) <i>Size - Format - Dimension</i> | Spessore (cm) <i>Thickness - Stärke - Épaisseur</i> | Prezzo (€) <i>Price - Preis - Prix</i> |
|--|---|---|--|
| LPDQ380 BB | 80 x 80 | 2,7 / 3,0 | 504,00 |
| LPDQ390 BB | 90 x 90 | 2,7 / 3,0 | 568,00 |
| LPDR 379 BB | 70 x 90 | 2,7 / 3,0 | 535,00 |
| LPDR 3710 BB | 70 x 100 | 2,7 / 3,0 | 568,00 |
| LPDR 3720 BB | 70 x 120 | 2,7 / 3,0 | 633,00 |
| LPDR 3740 BB | 70 x 140 | 2,7 / 3,0 | 689,00 |
| LPDR 3770 BB | 70 x 170 | 2,7 / 3,0 | 776,00 |
| LPDR 3810 BB | 80 x 100 | 2,7 / 3,0 | 600,00 |
| LPDR 3820 BB | 80 x 120 | 2,7 / 3,0 | 626,00 |
| LPDR 3840 BB | 80 x 140 | 2,7 / 3,0 | 691,00 |
| LPDR 3880 BB | 80 x 180 | 2,7 / 3,0 | 837,00 |
| LPDR 3920 BB | 90 x 120 | 2,7 / 3,0 | 689,00 |
| LPDR 3940 BB | 90 x 140 | 2,7 / 3,0 | 800,00 |
| LPDR 3980 BB | 90 x 180 | 2,7 / 3,0 | 854,00 |

E' disponibile servizio su misura con formati di larghezza da cm 70 fino a cm 100 e lunghezza da cm 70 a cm 200.
Sono disponibili su richiesta colorazioni RAL. Consegna in 35/40 gg.
Personalized colours (Ral) and sizes (from 70 to 100cm wide and from 70 to 200 cm long) available. Delivery in 35/40 days.
Benutzerdefinierte Farbe (RAL) und Größe (mit Breite von 70 bis 100 cm und Länge von 70 bis 200 cm) möglich. Lieferung in 35/40 Tagen.
Possibilità de couleurs (RAL) et de formats sur mesure : largeur de 70 cm à 100 cm - longueur de 70 cm à 200 cm. Délai de livraison: 35/40 jours.

Disponibile Kit di riparazione colore.
Available color repair kit. - Reparaturkit der gefärbten Gelcoat vorhanden. - Kit correction de couleur disponible.

Il prezzo è riferito al piatto completo di piletta e copripiletta.
Drain and drain cover included. Ab- und Überlaufgarnitur im Preis inbegriffen - Le prix correspond au receveur avec bonde et grille d'évacuation incluses.

Disegni tecnici a pag. 458 - Technical drawings on page 458 - Technische Zeichnung auf Seite 458 - Dessins techniques à la page 458.

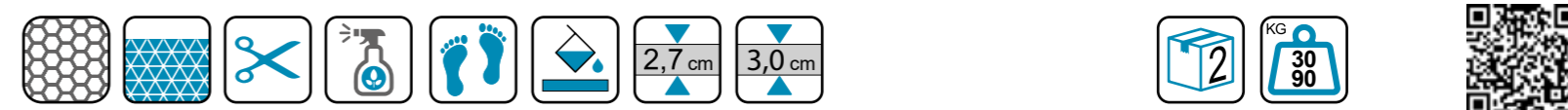



Antracite
Anthracite
Anthrazit
Anthracite

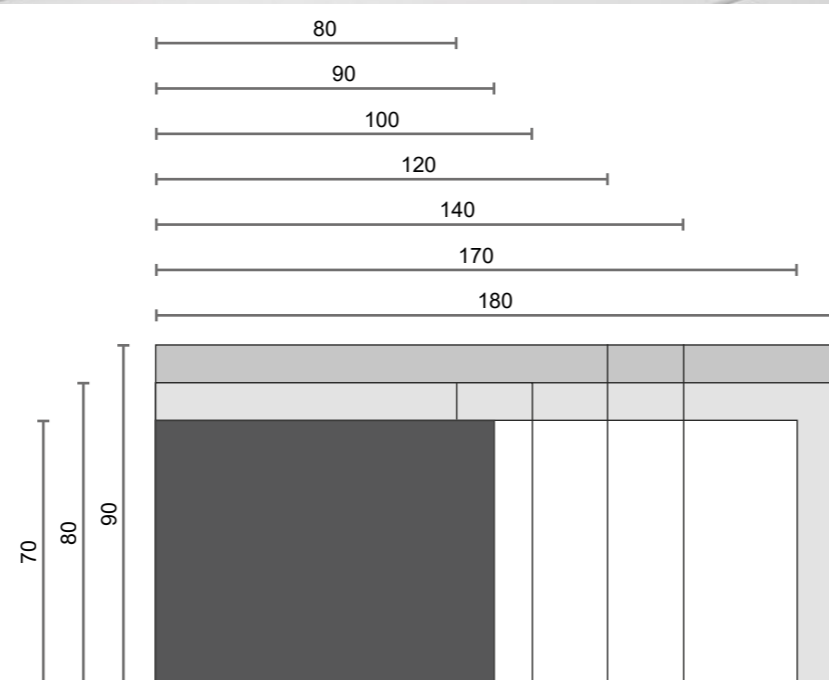

| CODICE <i>Code - Artikel - Article</i> | Formato (cm) <i>Size - Format - Dimension</i> | Spessore (cm) <i>Thickness - Stärke - Épaisseur</i> | Prezzo (€) <i>Price - Preis - Prix</i> |
|--|---|---|--|
| LPDQ380 BA | 80 x 80 | 2,7 / 3,0 | 504,00 |
| LPDQ390 BA | 90 x 90 | 2,7 / 3,0 | 568,00 |
| LPDR 379 BA | 70 x 90 | 2,7 / 3,0 | 535,00 |
| LPDR 3710 BA | 70 x 100 | 2,7 / 3,0 | 568,00 |
| LPDR 3720 BA | 70 x 120 | 2,7 / 3,0 | 633,00 |
| LPDR 3740 BA | 70 x 140 | 2,7 / 3,0 | 689,00 |
| LPDR 3770 BA | 70 x 170 | 2,7 / 3,0 | 776,00 |
| LPDR 3810 BA | 80 x 100 | 2,7 / 3,0 | 600,00 |
| LPDR 3820 BA | 80 x 120 | 2,7 / 3,0 | 626,00 |
| LPDR 3840 BA | 80 x 140 | 2,7 / 3,0 | 691,00 |
| LPDR 3880 BA | 80 x 180 | 2,7 / 3,0 | 837,00 |
| LPDR 3920 BA | 90 x 120 | 2,7 / 3,0 | 689,00 |
| LPDR 3940 BA | 90 x 140 | 2,7 / 3,0 | 800,00 |
| LPDR 3980 BA | 90 x 180 | 2,7 / 3,0 | 854,00 |

E' disponibile servizio su misura con formati di larghezza da cm 70 fino a cm 100 e lunghezza da cm 70 a cm 200.

Sono disponibili su richiesta colorazioni RAL. Consegna in 35/40 gg.

Personalized colours (Ral) and sizes (from 70 to 100cm wide and from 70 to 200 cm long) available. Delivery in 35/40 days.

Benutzerdefinierte Farbe (RAL) und Größe (mit Breite von 70 bis 100 cm und Länge von 70 bis 200 cm) möglich. Lieferung in 35/40 Tagen.

Possibilità de couleurs (RAL) et de formats sur mesure : largeur de 70 cm à 100 cm - longueur de 70 cm à 200 cm. Délai de livraison: 35/40 jours.

Disponibile Kit di riparazione colore.

Available color repair kit. - Reparaturkit der gefärbten Gelcoat vorhanden. - Kit correction de couleur disponible.

Il prezzo è riferito al piatto completo di piletta e copripiletta.

Drain and drain cover included. Ab- und Überlaufgarnitur im Preis inbegriffen - Le prix correspond au receveur avec bonde et grille d'évacuation incluses.

Disegni tecnici a pag. 458 - Technical drawings on page 458 - Technische Zeichnung auf Seite 458 - Dessins techniques à la page 458.



DISEGNI TECNICI SLATE EVO / BRECCIA

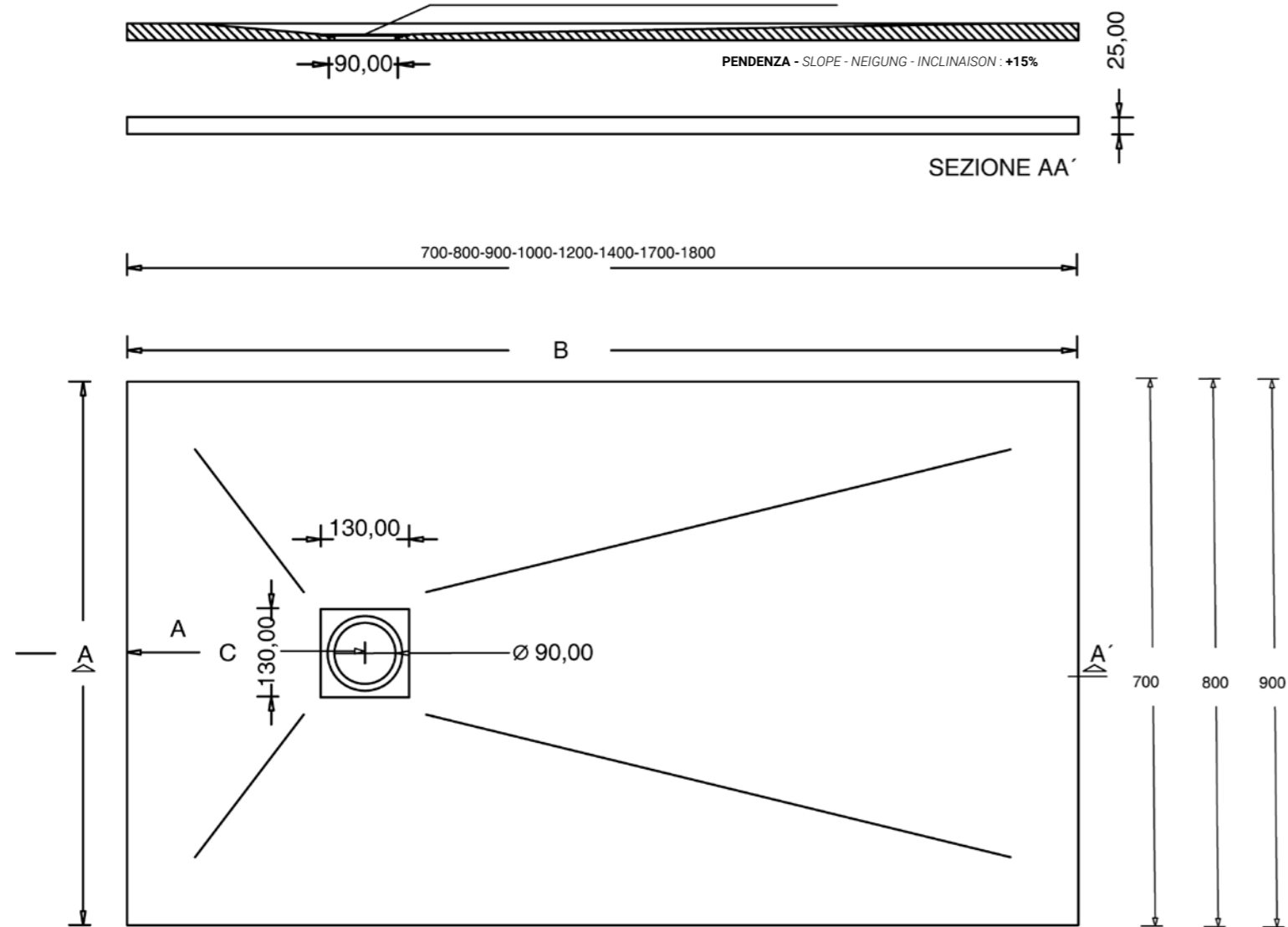

(70 - 80 - 90)

| B | C |
|-------------|------|
| 0cm - 100cm | 35cm |
| +100cm | 45cm |

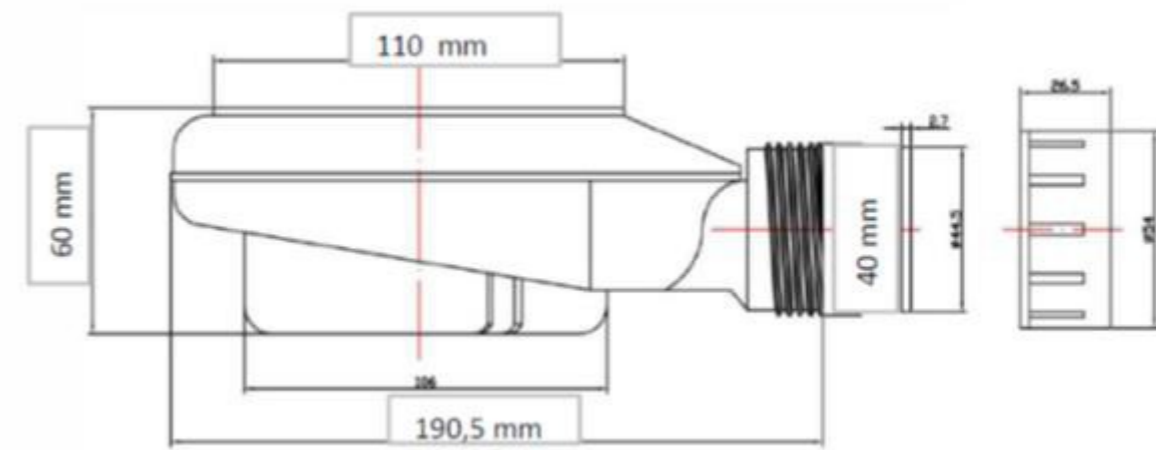

| | |
|--|-----------------------|
| PORTATA D'ACQUA: WATER FLOW: WASSERFLUS: L'ÉCOULEMENT DE L'EAU: | 42 LT./MIN |
| TEMPERATURA DI LAVORAZIONE: PROCESSING TEMPERATURE: VERARBEITUNGSTEMPERATUREN: TEMPÉRATURE DE FABRICATION: | MAX TEMP. 100° |
| PESO: WEIGHT: GEWITCH: POIDS: | 285 GR. |
| NORMATIVA: REFERENCE LEGISLATION: IGESETZGEBUNG: LEGISLATION: | EN-274-2 |

LIMESTONE

CARATTERISTICHE GENERALI

- Realizzati in polvere di marmo, carbonato di calcio, quarzo e resina.
- Spessore cm 3.
- Piletta di scarico e copripiletta in dotazione (33 L/Min).
- Superficie strutturata e antiscivolo.
- Superficie colorata in Gel coat.
- Struttura piena.
- Possibilità di taglio.

GENERAL CHARACTERISTICS

- *Made of marble powder, calcium carbonate, quartz and resin.*
- *3-cm thick.*
- *Drain and drain cover included (33 liter/minute).*
- *Antislip texture.*
- *Colored surface in Gel coat.*
- *Full structure.*
- *Possible to cut.*

ALLGEMEINE EIGENSCHAFTEN

- *Aus Marmorpulver, Kalziumkarbonat, Quarz und Harz hergestellt.*
- *Stärke 3 cm.*
- *Ab- und Überlaufgarnitur im Preis inbegriffen (33 L/Minute).*
- *Rutschfeste strukturierte Oberfläche.*
- *Gefärbgte Oberfläche mit Gelcoat*
- *Ganze Masse*
- *Kürzbar*

SPECIFICATIONS GENERALES

- *Fabriqués en poudre de marbre, carbonate de calcium, quartz et résine.*
- *Épaisseur 3 cm.*
- *Bonde (33 l/min) et grille d'évacuation incluses.*
- *Texture antidérapante.*
- *Surface colorée en Gel coat.*
- *Plein cadre.*
- *Découpable.*

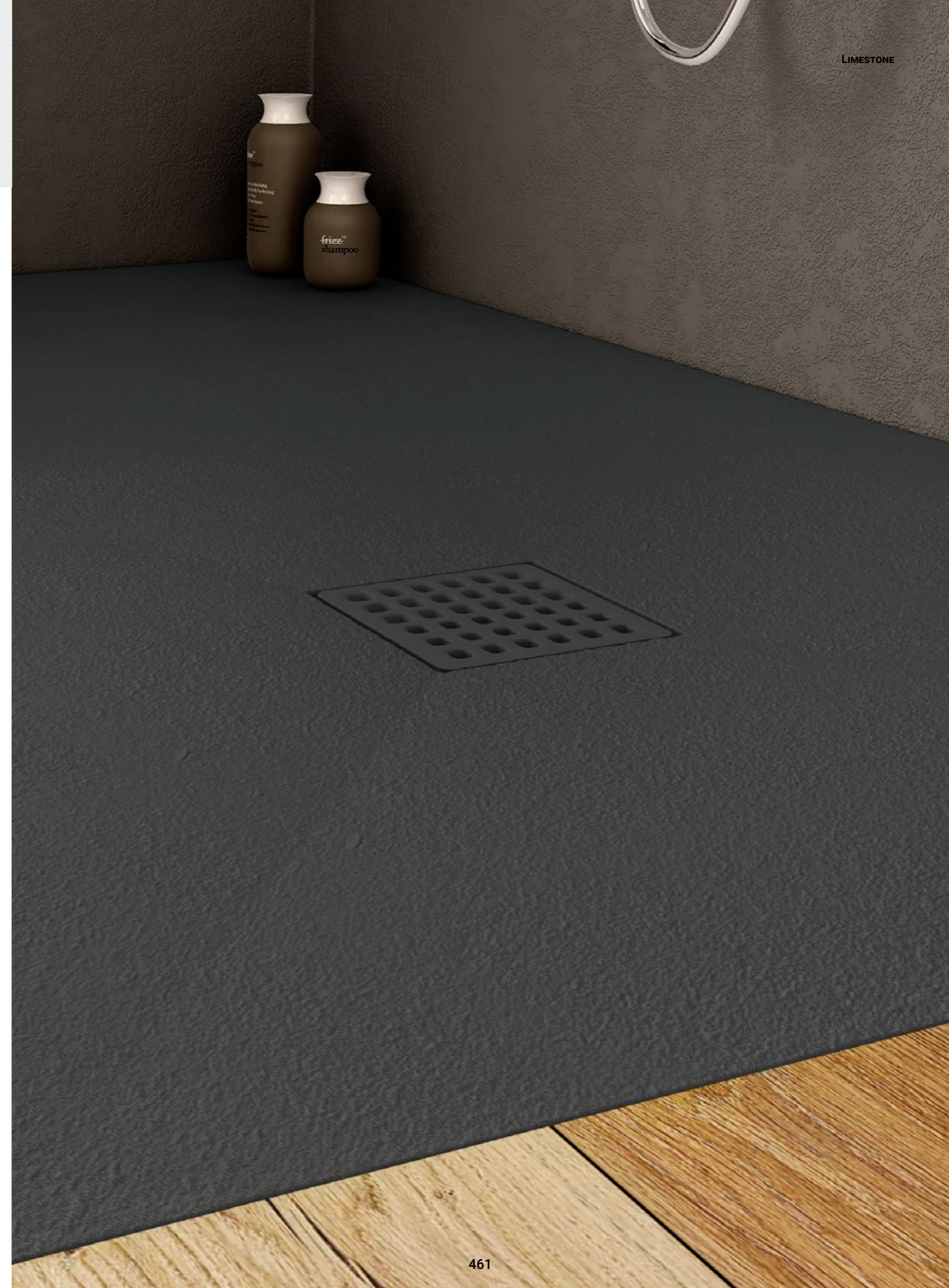

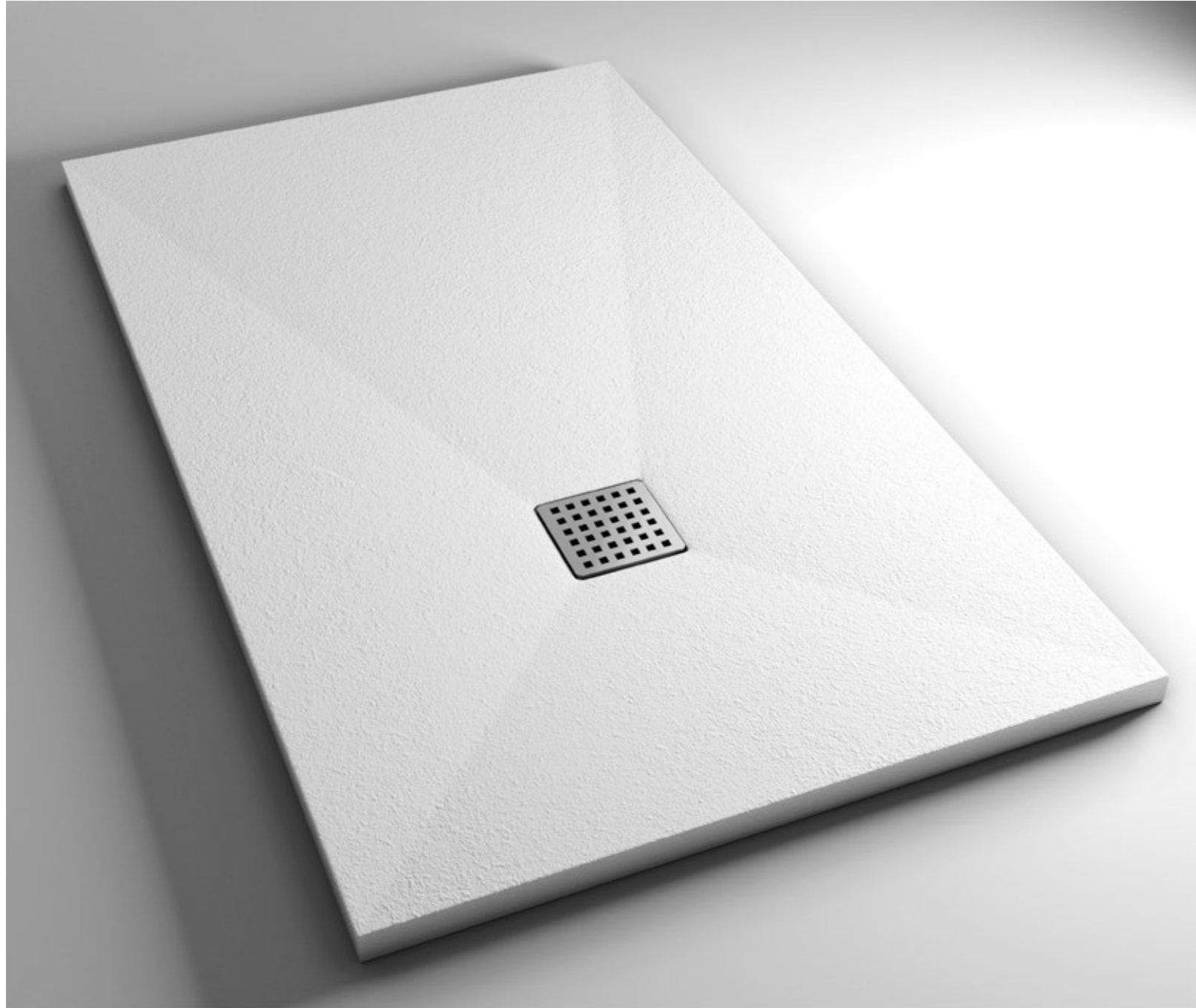

Bianco
White
Weiß
Blanc

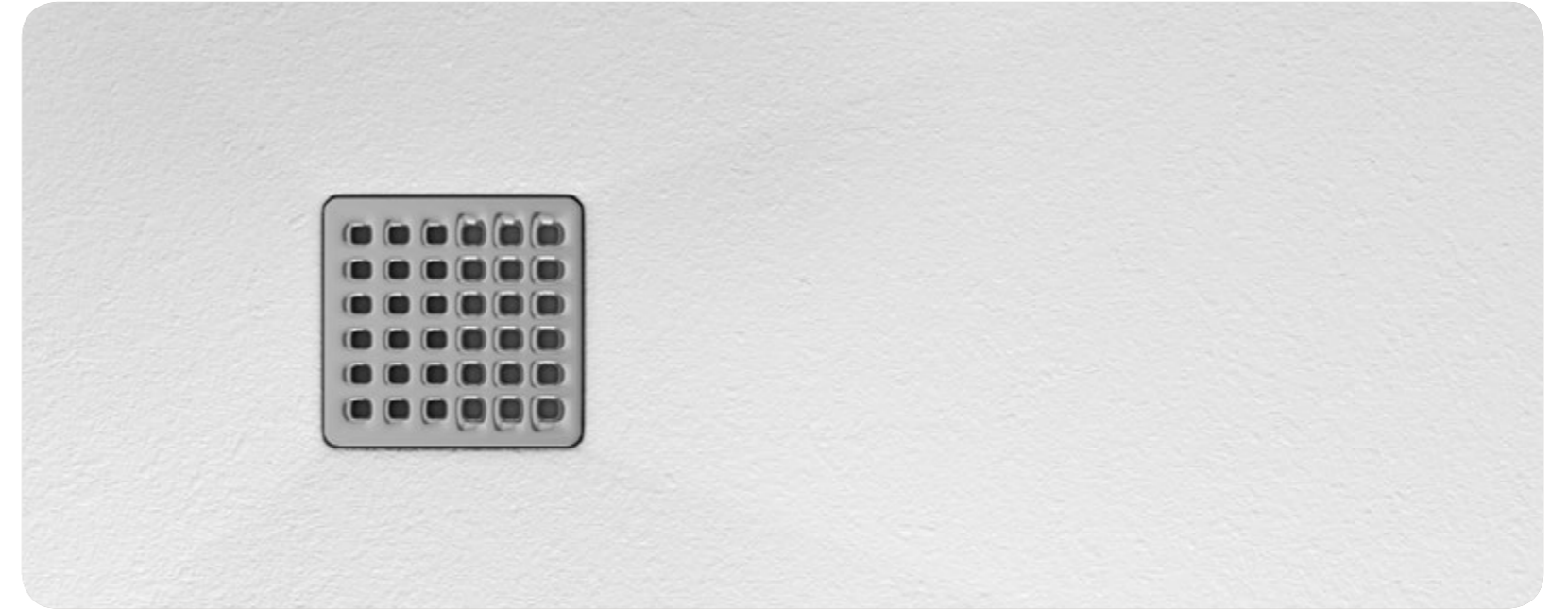
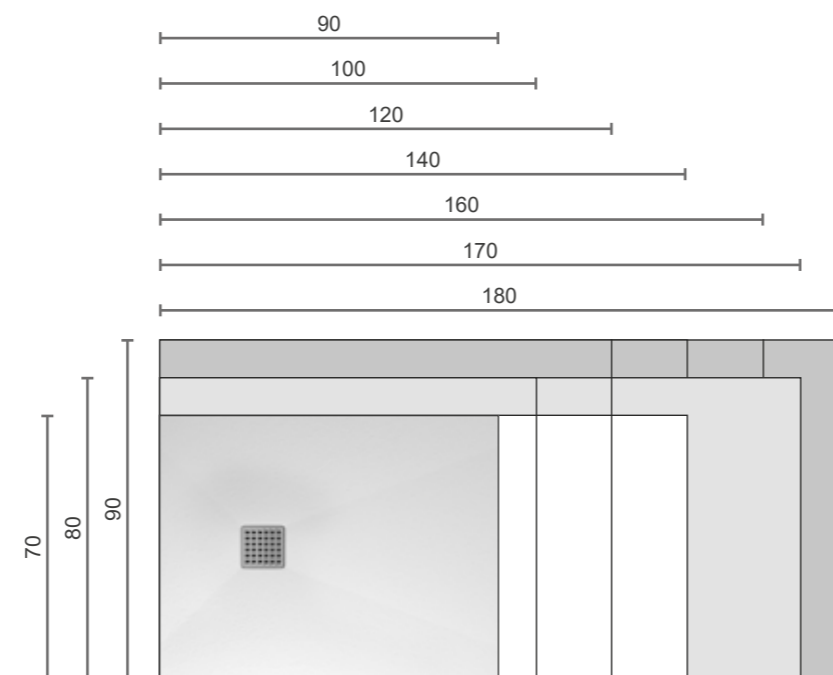

| CODICE <i>Code - Artikel - Article</i> | Formato (cm) <i>Size - Format - Dimension</i> | Spessore (cm) <i>Thickness - Stärke - Épaisseur</i> | Prezzo (€) <i>Price - Preis - Prix</i> |
|--|---|---|--|
| LPDR3 79LB | 70 x 90 | 3 | 480,00 |
| LPDR3 710LB | 70 x 100 | 3 | 500,00 |
| LPDR3 720LB | 70 x 120 | 3 | 624,00 |
| LPDR3 740LB | 70 x 140 | 3 | 723,00 |
| LPDR3 810LB | 80 x 100 | 3 | 556,00 |
| LPDR3 820LB | 80 x 120 | 3 | 665,00 |
| LPDR3 870LB | 80 x 170 | 3 | 883,00 |
| LPDR3 920LB | 90 x 120 | 3 | 723,00 |
| LPDR3 940LB | 90 x 140 | 3 | 821,00 |
| LPDR3 960LB | 90 x 160 | 3 | 911,00 |
| LPDR3 980LB | 90 x 180 | 3 | 992,00 |

Copripietta in dotazione Cromo. - Chrome drain cover included.
Verchromte Überlaufgarnitur im Preis inbegriffen. - La grille d'évacuation chromée est comprise dans le prix.

Disponibile Kit di riparazione colore. - Available color repair kit.
Reparaturkit der gefärbten Gelcoat vorhanden. - Kit correction de couleur disponible.

Il prezzo è riferito al piatto completo di piletta e copripietta (33 l/Min).
*Drain and drain cover included (33 l/m).
Ab- und Überlaufgarnitur im Preis inbegriffen (33 l/m).
Le prix correspond au receveur avec bonde et grille d'évacuation (33 l/min).*

E' disponibile su richiesta copripietta dello stesso colore del piatto con sovrapprezzo di € 31,00.
*On request drain cover with the same colour of the shower tray with surcharge € 31,00.
Auf Wunsch steht Überlaufgarnitur mit der gleichen Farbe der Duschtaße Aufpreis € 31,00 zur Verfügung.
Grille d'évacuation de la même couleur que le receveur disponible avec un supplément de € 31,00.*



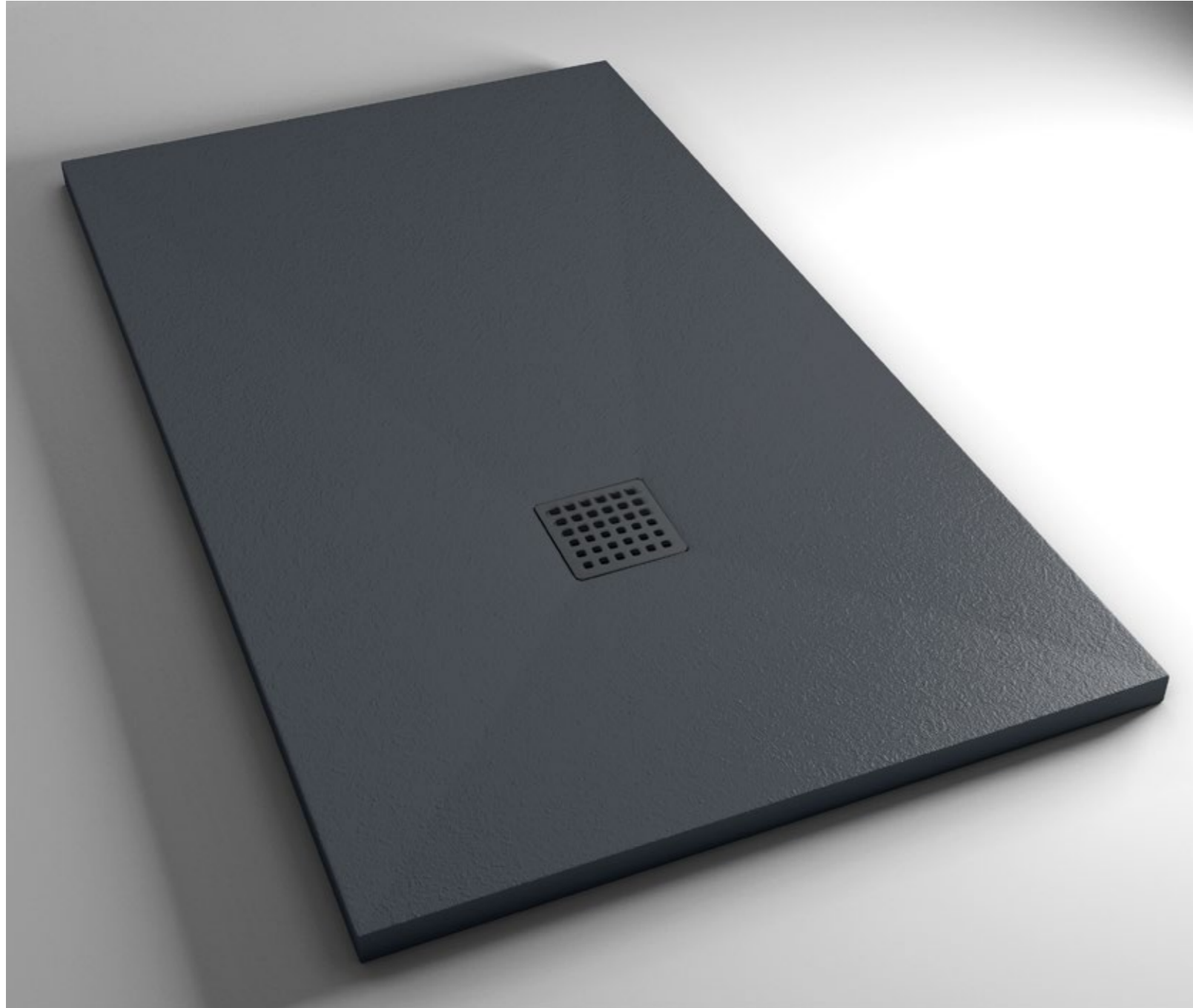

Antracite
Anthracite
Anthrazit
Anthracite

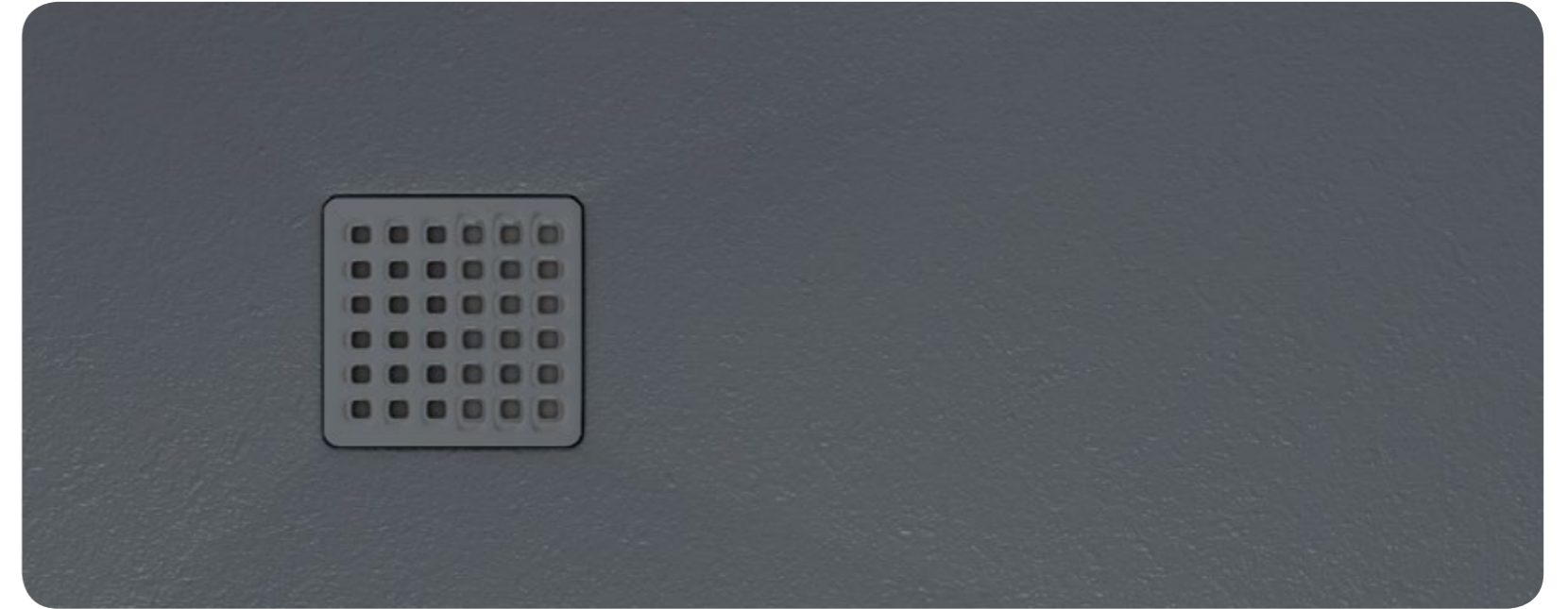
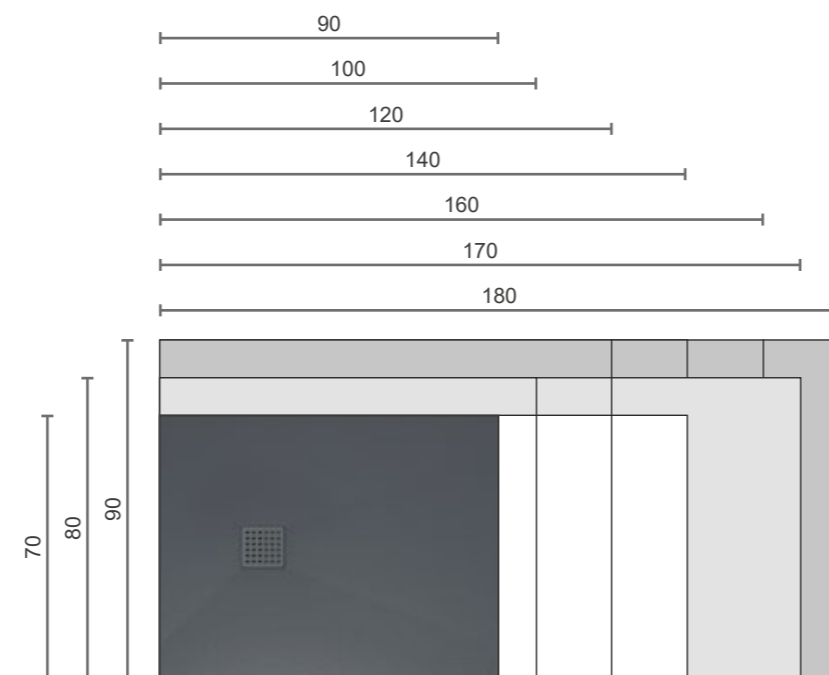

| CODICE <i>Code - Artikel - Article</i> | Formato (cm) <i>Size - Format - Dimension</i> | Spessore (cm) <i>Thickness - Stärke - Épaisseur</i> | Prezzo (€) <i>Price - Preis - Prix</i> |
|--|---|---|--|
| LPDR3 79LA | 70 x 90 | 3 | 480,00 |
| LPDR3 710LA | 70 x 100 | 3 | 500,00 |
| LPDR3 720LA | 70 x 120 | 3 | 624,00 |
| LPDR3 740LA | 70 x 140 | 3 | 723,00 |
| LPDR3 810LA | 80 x 100 | 3 | 556,00 |
| LPDR3 820LA | 80 x 120 | 3 | 665,00 |
| LPDR3 870LA | 80 x 170 | 3 | 883,00 |
| LPDR3 920LA | 90 x 120 | 3 | 723,00 |
| LPDR3 940LA | 90 x 140 | 3 | 821,00 |
| LPDR3 960LA | 90 x 160 | 3 | 911,00 |
| LPDR3 980LA | 90 x 180 | 3 | 992,00 |

Copripietta in dotazione Cromo. - Chrome drain cover included.
Verchromte Überlaufgarnitur im Preis inbegriffen. - La grille d'évacuation chromée est comprise dans le prix.

Disponibile Kit di riparazione colore. - Available color repair kit.
Reparaturkit der gefärbten Gelcoat vorhanden. - Kit correction de couleur disponible.

Il prezzo è riferito al piatto completo di piletta e copripietta (33 l/Min).

*Drain and drain cover included (33 l/m).
Ab- und Überlaufgarnitur im Preis inbegriffen (33 l/m).
Le prix correspond au receveur avec bonde et grille d'évacuation (33 l/min).*

E' disponibile su richiesta copripietta dello stesso colore del piatto con sovrapprezzo di € 31,00.

*On request drain cover with the same colour of the shower tray with surcharge € 31,00.
Auf Wunsch steht Überlaufgarnitur mit der gleichen Farbe der Duschtaße Aufpreis € 31,00 zur Verfügung.
Grille d'évacuation de la même couleur que le receveur disponible avec un supplément de € 31,00.*



DISEGNI TECNICI LIMESTONE

TECHNICAL DRAWING
TECHNISCHE ZEICHNUNG
DESSIN TECHNIQUE

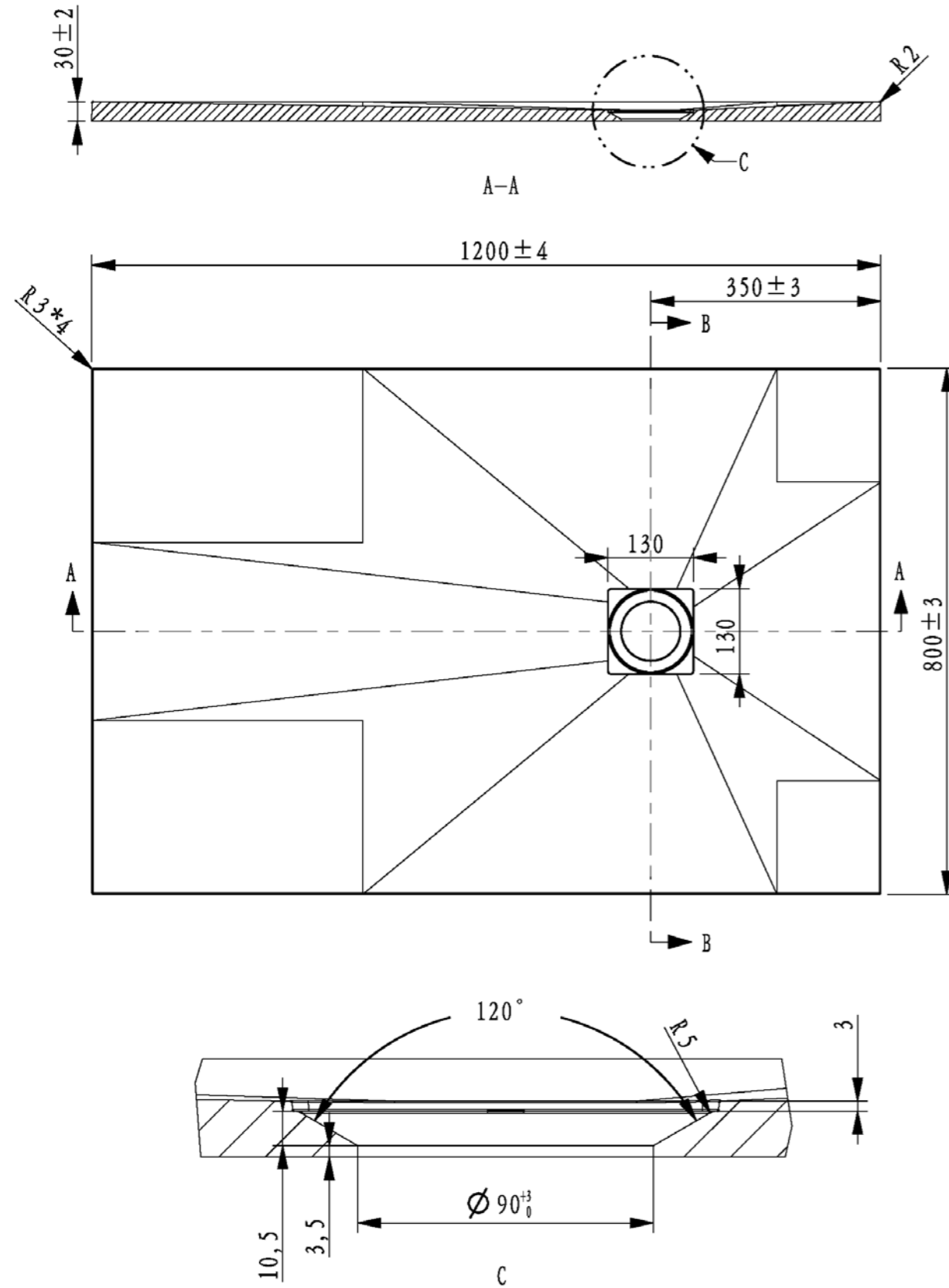

- Piletta Standard in dotazione ai piatti doccia Limestone.

- Standard drain included (Shower trays "Limestone").

- Standard Ablaufgarnitur für die Serie Limestone. Im Preis inbegriffen.

- Bonde standard incluse pour les receveurs «Limestone».

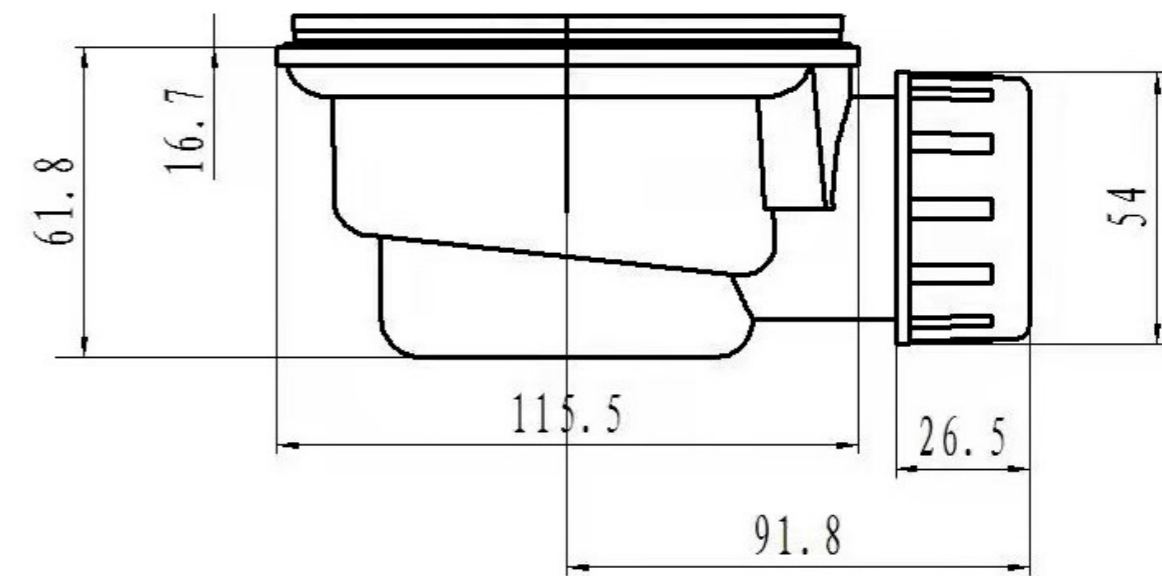

PETRA

CARATTERISTICHE GENERALI

- I piatti doccia Petra sono realizzati in polvere di marmo, carbonato di calcio, quarzo e resina.
- Il corpo del piatto è colorato in pasta.
- Spessore 3 cm.
- Piletta di scarico e copripiletta in dotazione (42 L/Min).
- Superficie strutturata e antiscivolo.
- Possibilità di taglio.
- Disponibile Kit di riparazione colore.

GENERAL CHARACTERISTICS

- The shower trays Petra are made of marble powder, calcium carbonate, quartz and resin.
- The body of the shower tray is colored.
- Thickness of 3 cm.
- Drain and drain cover included (42 liter/minute).
- Antislip texture.
- Possible to cut.
- Available colour repair kit.

ALLGEMEINE EIGENSCHAFTEN

- Aus Marmorpulver, Kalziumkarbonat, Quarz und Harz hergestellt.
- Der Körper der Duschwanne ist farbig.
- Stärke 3 cm.
- Ab- und Überlaufgarnitur im Preis inbegriffen (42 L/Minute).
- Rutschfeste strukturierte Oberfläche.
- Kürzbar.
- Reparaturkit der Farbe vorhanden.

SPECIFICATIONS GENERALES

- Les receveurs sont fabriqués en poudre de marbre, carbonate de calcium, quartz et résine.
- Ils sont colorés dans la masse.
- Épaisseur 3 cm.
- Bonde (42 l/min) et grille d'évacuation incluses.
- Texture antidérapante.
- Découpable.
- Kit correction de couleur disponible.





| CODICE <i>Code - Artikel - Article</i> | Formato (cm) <i>Size - Format - Dimension</i> | Spessore (cm) <i>Thickness - Stärke - Épaisseur</i> | Prezzo (€) <i>Price - Preis - Prix</i> |
|--|---|---|--|
| LPDR3 710PB | 70 x 100 | 3 | 609,00 |
| LPDR3 720PB | 70 x 120 | 3 | 680,00 |
| LPDR3 740PB | 70 x 140 | 3 | 762,00 |
| LPDR3 780PB | 70 x 180 | 3 | 909,00 |
| LPDR3 810PB | 80 x 100 | 3 | 662,00 |
| LPDR3 820PB | 80 x 120 | 3 | 750,00 |
| LPDR3 840PB | 80 x 140 | 3 | 835,00 |
| LPDR3 880PB | 80 x 180 | 3 | 1.015,00 |
| LPDR3 920PB | 90 x 120 | 3 | 827,00 |
| LPDR3 940PB | 90 x 140 | 3 | 927,00 |
| LPDR3 980PB | 90 x 180 | 3 | 1.120,00 |

Disponibile Kit di riparazione colore. - Available color repair kit.
Reparaturkit der gefärbten Gelcoat vorhanden. - Kit correction de couleur disponible.

Il prezzo è riferito al piatto completo di piletta e copripiletta. - Drain and drain cover included.
Ab- und Überlaufgarnitur im Preis inbegriffen - Le prix correspond au receveur avec bonde et grille d'évacuation incluses.

Bianco
White
Weiß
Blanc

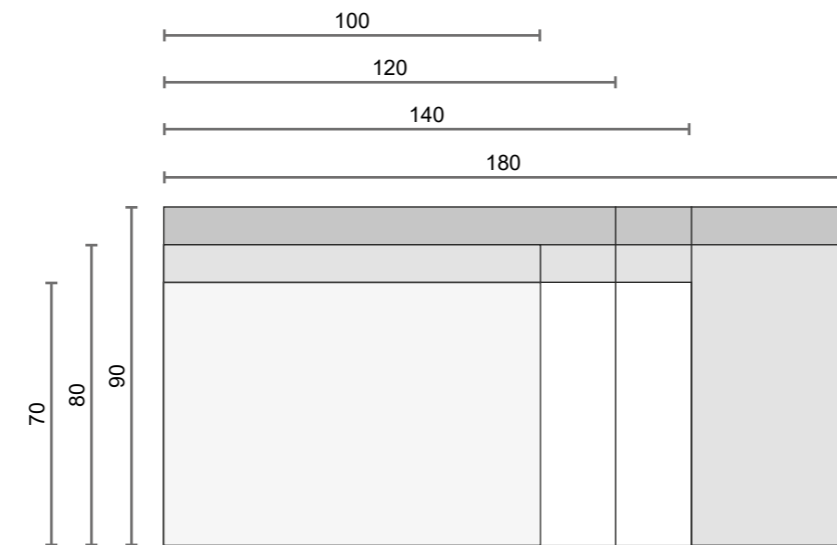

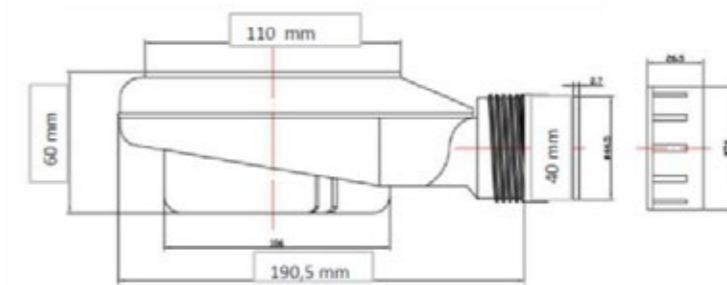
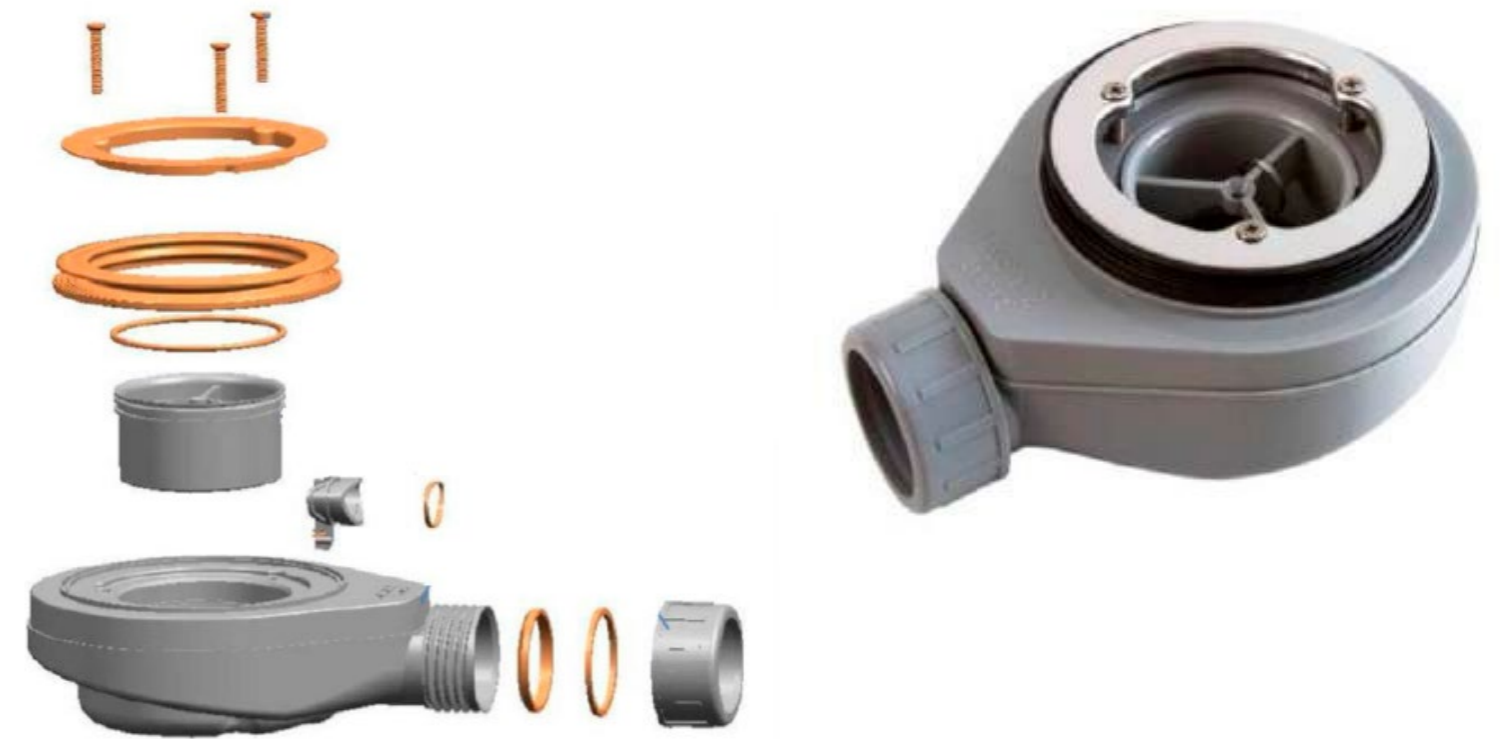
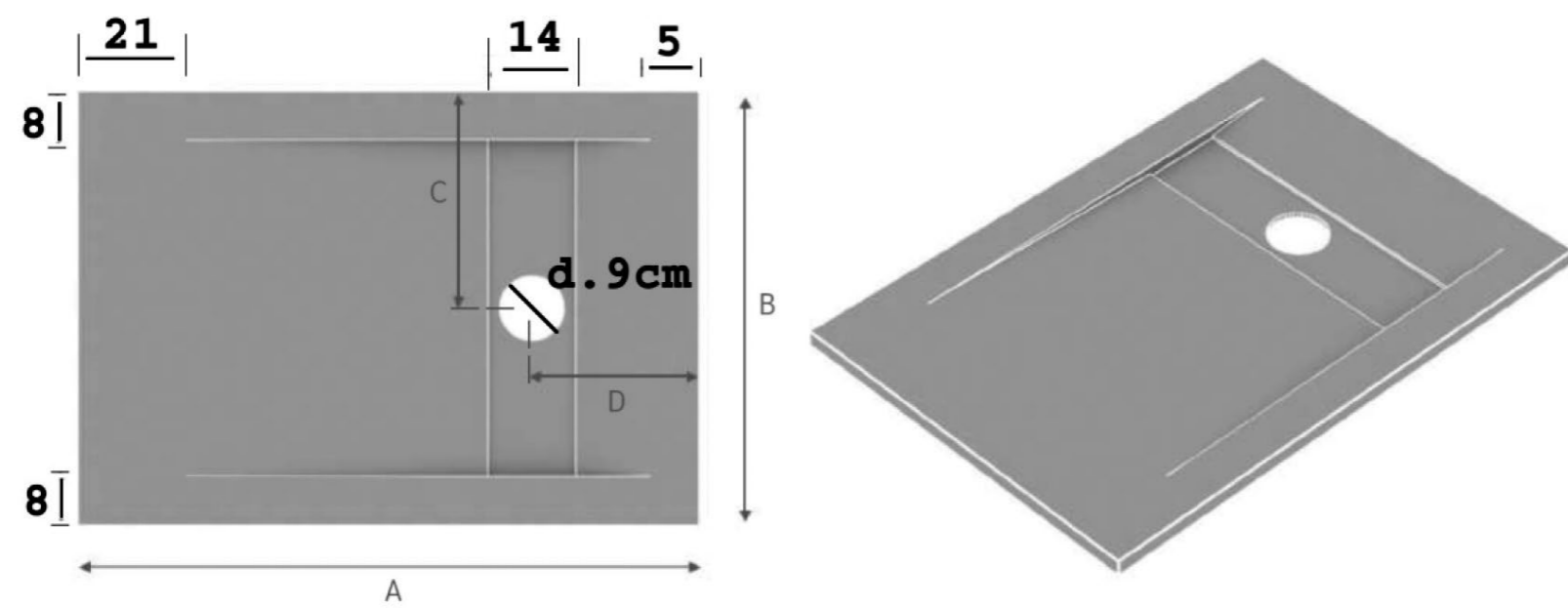

| | |
|--|-----------------------|
| PORTATA D'ACQUA: WATER FLOW: WASSERFLUS: L'ÉCOULEMENT DE L'EAU: | 42 LT./MIN |
| TEMPERATURA DI LAVORAZIONE: PROCESSING TEMPERATURE: VERARBEITUNGSTEMPERATUREN: TEMPÉRATURE DE FABRICATION: | MAX TEMP. 100° |
| PESO: WEIGHT: GEWITCH: POIDS: | 285 GR. |
| NORMATIVA: REFERENCE LEGISLATION: IGESETZGEBUNG: LEGISLATION: | EN-274-2 |

CARATTERISTICHE GENERALI

- Realizzati in carbonato di calcio, quarzo e resina.
- Spessore cm 3,5.
- Colore bianco e nero.
- Piletta di scarico e copripiletta in dotazione (33 L/Min).
- Il corpo del piatto è bianco.
- Superficie liscia e antiscivolo.

GENERAL CHARACTERISTICS

- *Made of calcium carbonate, quartz and resin.*
- *3,5-cm thick.*
- *White and black colour.*
- *Drain and drain cover included (33 liter/minute).*
- *White body.*
- *Shiny antislip texture.*

ALLGEMEINE EIGENSCHAFTEN

- *Hergestellt aus Kalziumkarbonat, Quarz und Harz.*
- *Stärke 3,5 cm.*
- *Schwarze und weiße Farben.*
- *Ab- und Überlaufgarnitur im Preis inbegriffen (33 L/Minute).*
- *Weiße Masse.*
- *Glänzende, rutschfeste Oberfläche.*

SPECIFICATIONS GENERALES

- *Fabriqués en carbonate de calcium, quartz et résine.*
- *Épaisseur 3,5 cm.*
- *Couleurs noir et blanc.*
- *Bonde (33 l/min) et grille d'évacuation incluses.*
- *Le corps du receveur est blanc.*
- *Texture polie et antidérapante.*





Bianco
White
Weiß
Blanc

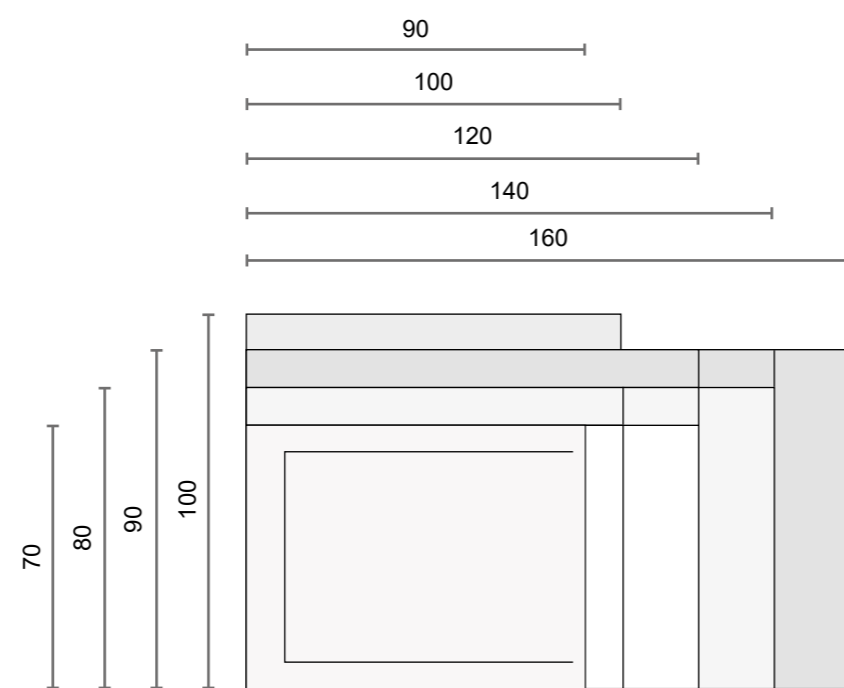

476

| CODICE <i>Code - Artikel - Article</i> | Formato (cm) <i>Size - Format - Dimension</i> | Spessore (cm) <i>Thickness - Stärke - Épaisseur</i> | Prezzo (€) <i>Price - Preis - Prix</i> |
|--|---|---|--|
| LPDQ4 80WSB | 80 x 80 | 3,5 | 403,00 |
| LPDQ4 90WSB | 90 x 90 | 3,5 | 451,00 |
| LPDQ4 100WSB | 100 x 100 | 3,5 | 481,00 |
| LPDR4 79WSB | 70 x 90 | 3,5 | 334,00 |
| LPDR4 710WSB | 70 x 100 | 3,5 | 371,00 |
| LPDR4 720WSB | 70 x 120 | 3,5 | 416,00 |
| LPDR4 810WSB | 80 x 100 | 3,5 | 416,00 |
| LPDR4 820WSB | 80 x 120 | 3,5 | 433,00 |
| LPDR4 840WSB | 80 x 140 | 3,5 | 525,00 |
| LPDR4 920WSB | 90 x 120 | 3,5 | 512,00 |
| LPDR4 940WSB | 90 x 140 | 3,5 | 585,00 |
| LPDR4 960WSB | 90 x 160 | 3,5 | 689,00 |

Il prezzo è riferito al piatto completo di piletta e copripiletta (33 L/Min).

Drain and drain cover included (33 liter/minute).

Ab- und Überlaufgarnitur im Preis inbegriffen (33 L/Minute).

Le prix correspond au receveur avec bonde (33 l/min) et grille d'évacuation incluses.

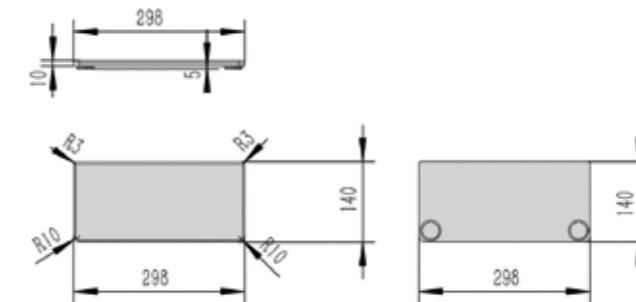

477

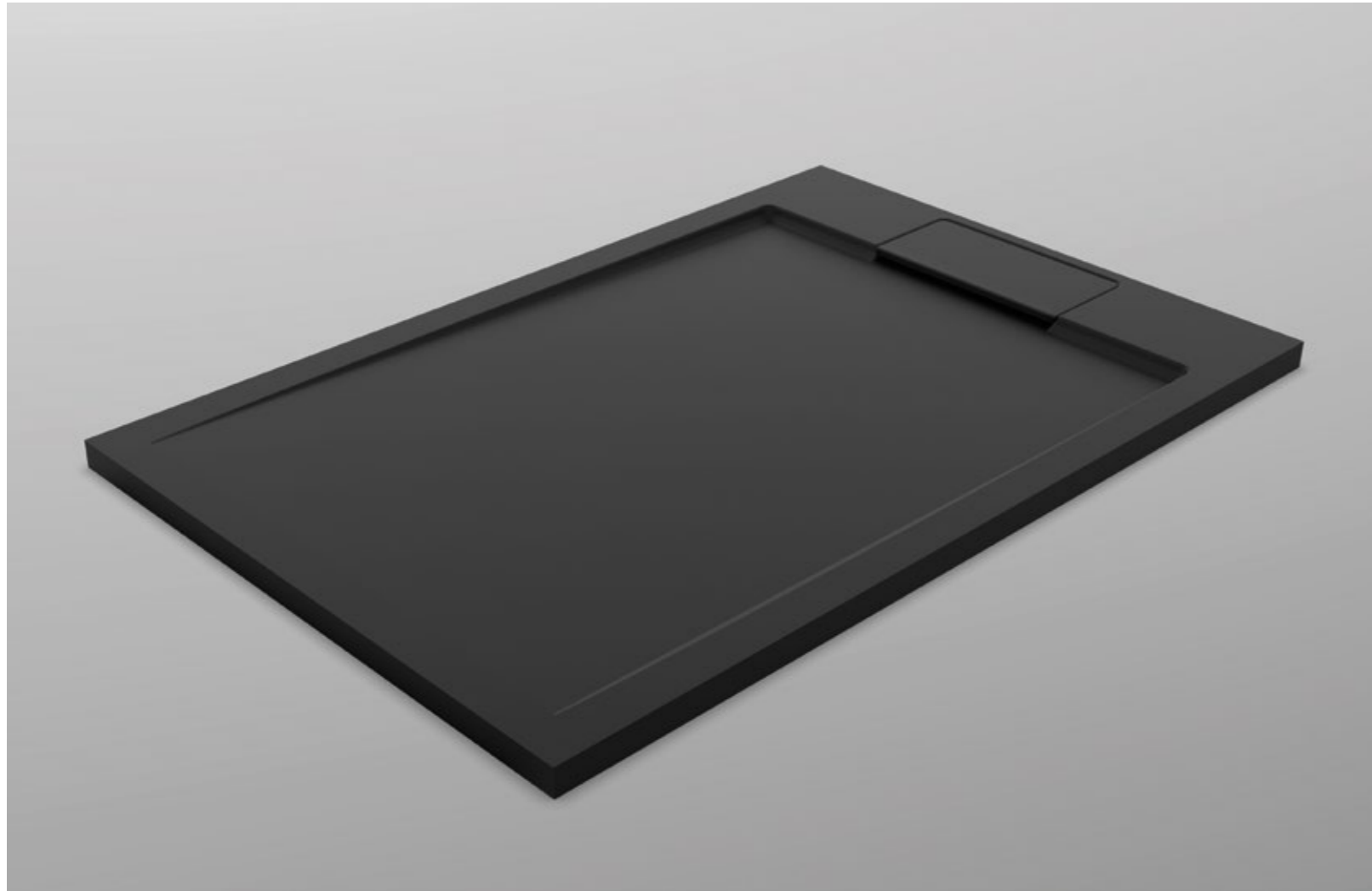

Nero
Black
Schwarz
Noir

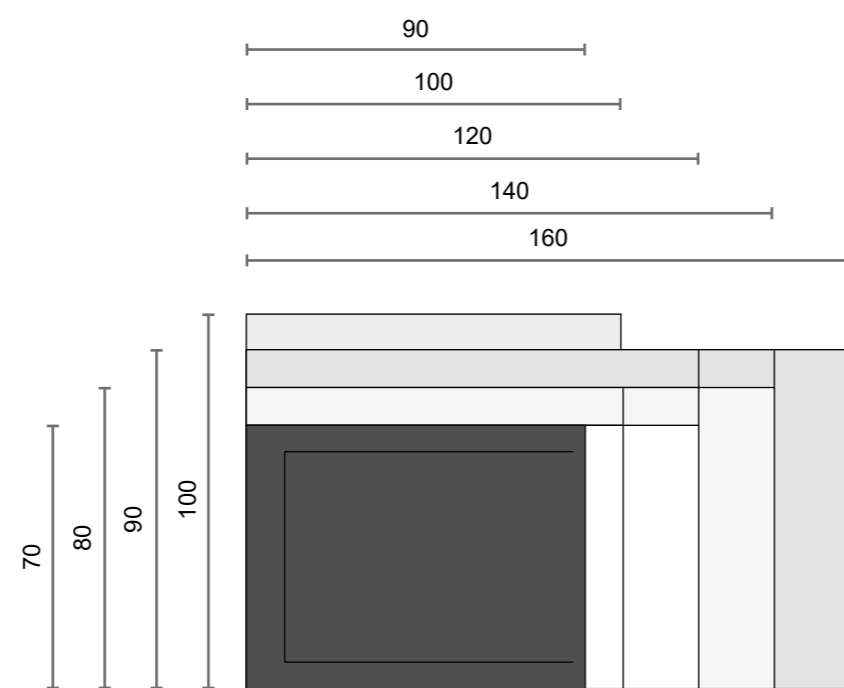

478

| CODICE <small>Code - Artikel - Article</small> | Formato (cm) <small>Size - Format - Dimension</small> | Spessore (cm) <small>Thickness - Stärke - Épaisseur</small> | Prezzo (€) <small>Price - Preis - Prix</small> |
|--|---|---|--|
| LPDQ4 80BSN | 80 x 80 | 3,5 | 475,00 |
| LPDQ4 90BSN | 90 x 90 | 3,5 | 512,00 |
| LPDQ4 100BSN | 100 x 100 | 3,5 | 563,00 |
| LPDR4 79BSN | 70 x 90 | 3,5 | 425,00 |
| LPDR4 710BSN | 70 x 100 | 3,5 | 465,00 |
| LPDR4 720BSN | 70 x 120 | 3,5 | 534,00 |
| LPDR4 810BSN | 80 x 100 | 3,5 | 530,00 |
| LPDR4 820BSN | 80 x 120 | 3,5 | 569,00 |
| LPDR4 840BSN | 80 x 140 | 3,5 | 651,00 |
| LPDR4 920BSN | 90 x 120 | 3,5 | 631,00 |
| LPDR4 940BSN | 90 x 140 | 3,5 | 726,00 |
| LPDR4 960BSN | 90 x 160 | 3,5 | 855,00 |

Il prezzo è riferito al piatto completo di piletta e copripiletta (33 L/Min).

Drain and drain cover included (33 liter/minute).

Ab- und Überlaufgarnitur im Preis inbegriffen (33 L/Minute).

Le prix correspond au receveur avec bonde (33 l/min) et grille d'évacuation incluses.

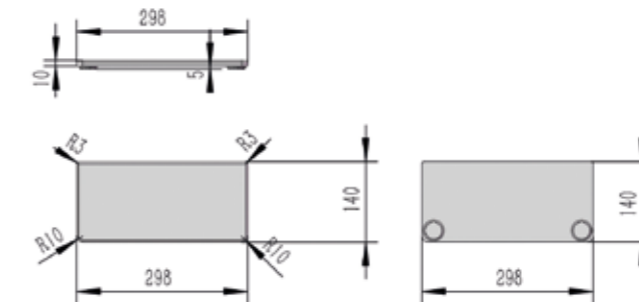

479

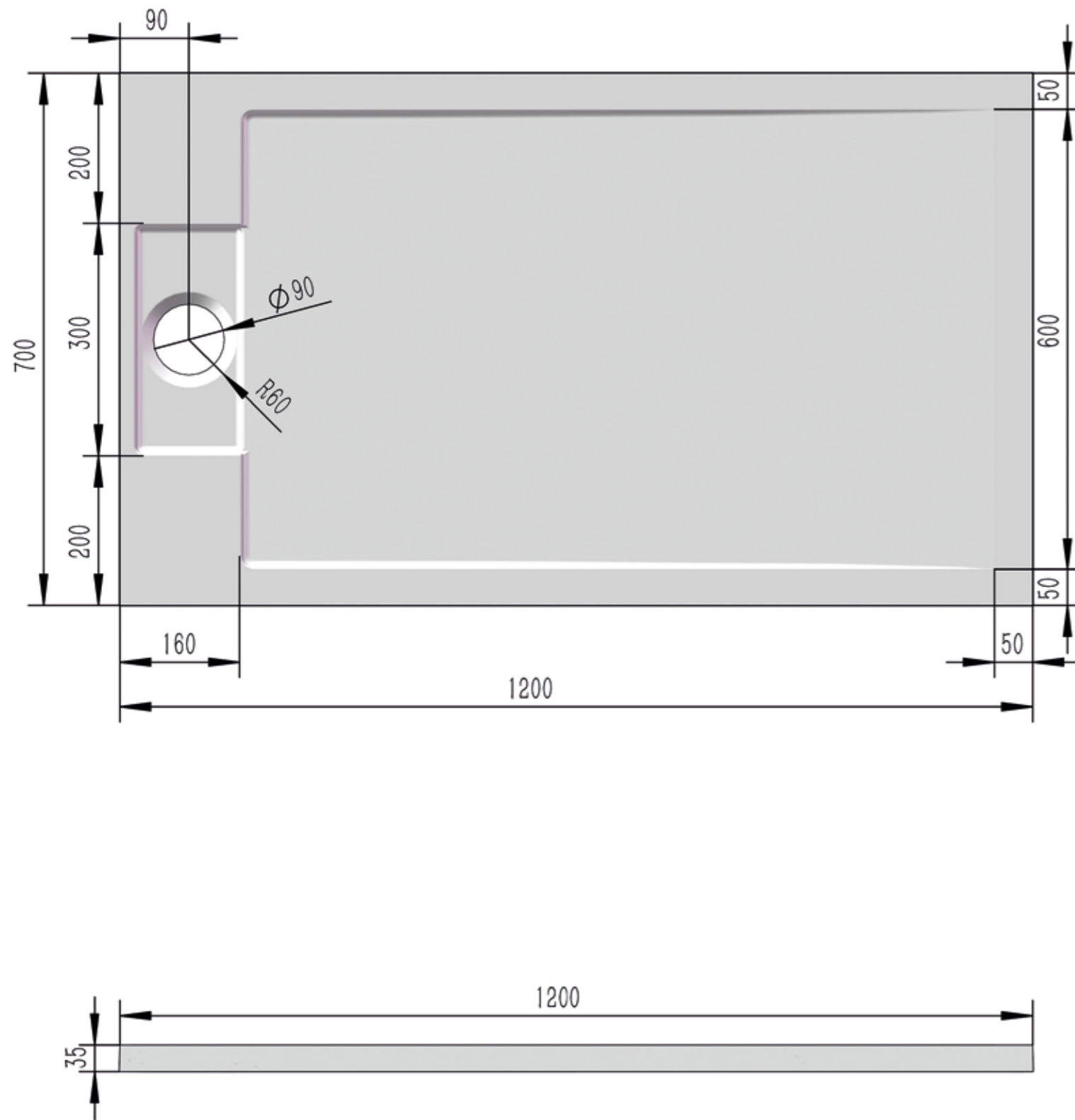

- Piletta Standard in dotazione ai piatti doccia Silk -
 - Standard drain included (Shower trays "Silk") -
 - Standard Ablaufgarnitur für die Serie Silk. Im Preis inbegriffen -
 - Bonde standard incluse pour les receveurs «Silk» -

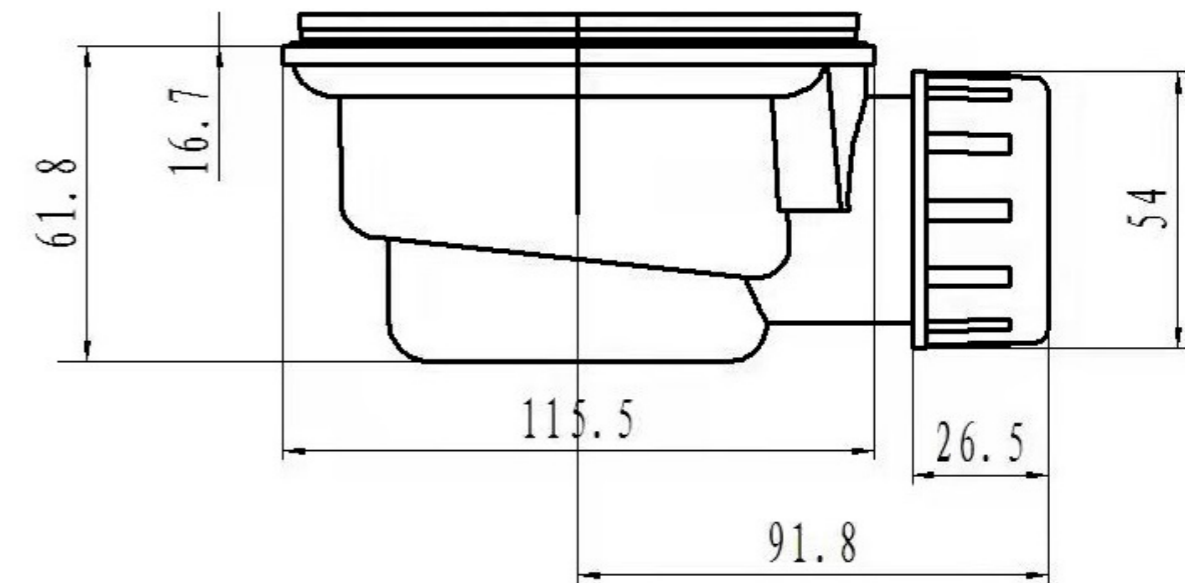

CARATTERISTICHE GENERALI

- Realizzati in carbonato di calcio, quarzo e resina.
- Spessore cm 3.
- Colore bianco.
- Piletta di scarico e copripiletta in dotazione (33 L/Min).
- Il corpo del piatto è bianco.
- Superficie lucida e antiscivolo.

GENERAL CHARACTERISTICS

- *Made of calcium carbonate, quartz and resin.*
- *3-cm thick.*
- *White colour.*
- *Drain and drain cover included (33 liter/minute).*
- *White body.*
- *Shiny antislip texture.*

ALLGEMEINE EIGENSCHAFTEN

- *Hergestellt aus Kalziumkarbonat, Quarz und Harz.*
- *Stärke 3 cm.*
- *Weiß.*
- *Ab- und Überlaufgarnitur im Preis inbegriffen (33 L/Minute).*
- *Weißer Masse.*
- *Glänzende rutschfeste Oberfläche.*

SPECIFICATIONS GENERALES

- *Fabriqués en carbonate de calcium, quartz et résine.*
- *Épaisseur 3 cm.*
- *Blanc.*
- *Bonde (33 l/min) et grille d'évacuation incluses.*
- *Le corps du receveur est blanc.*
- *Texture polie et antidérapante.*



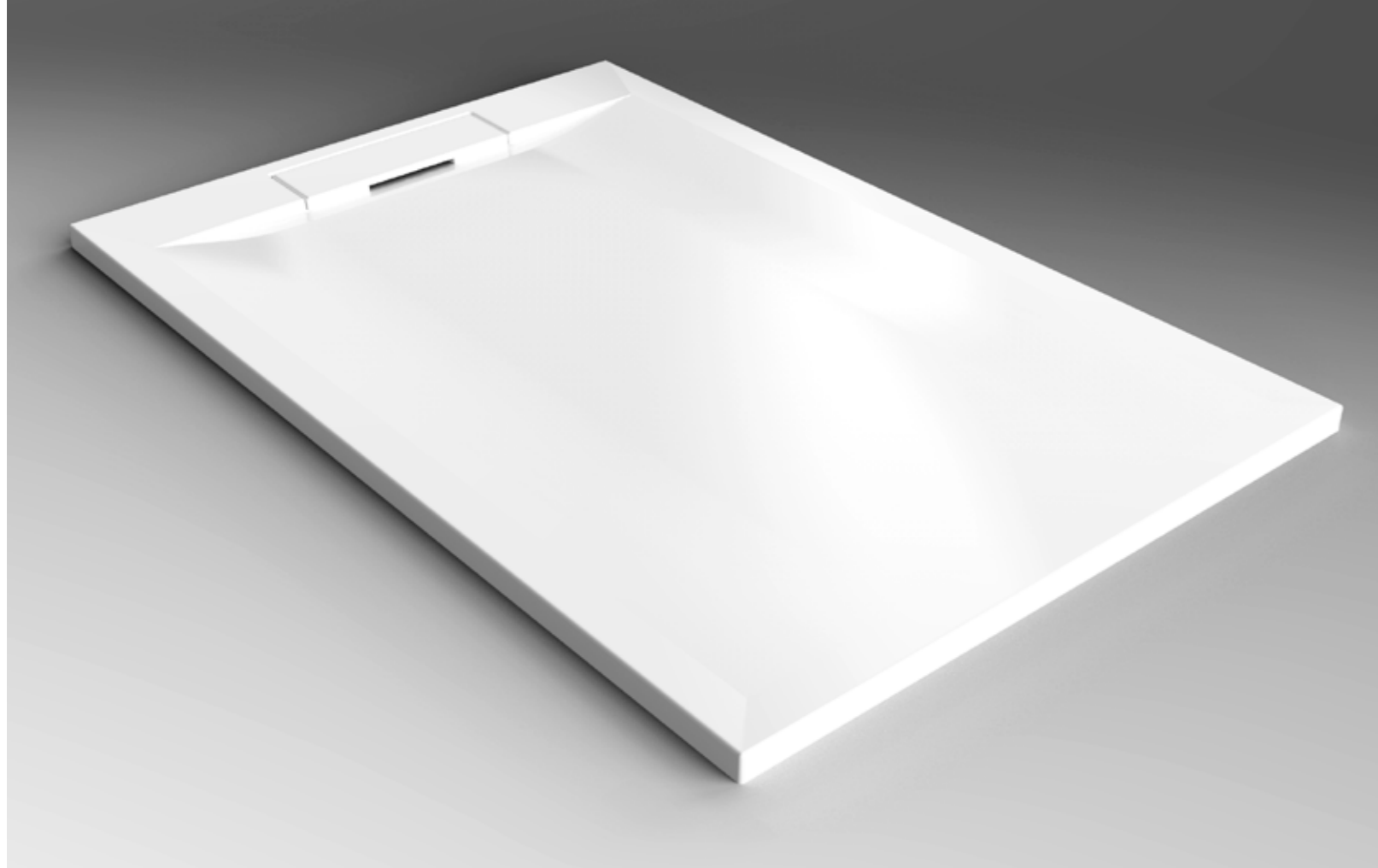

Bianco
White
Weiß
Blanc

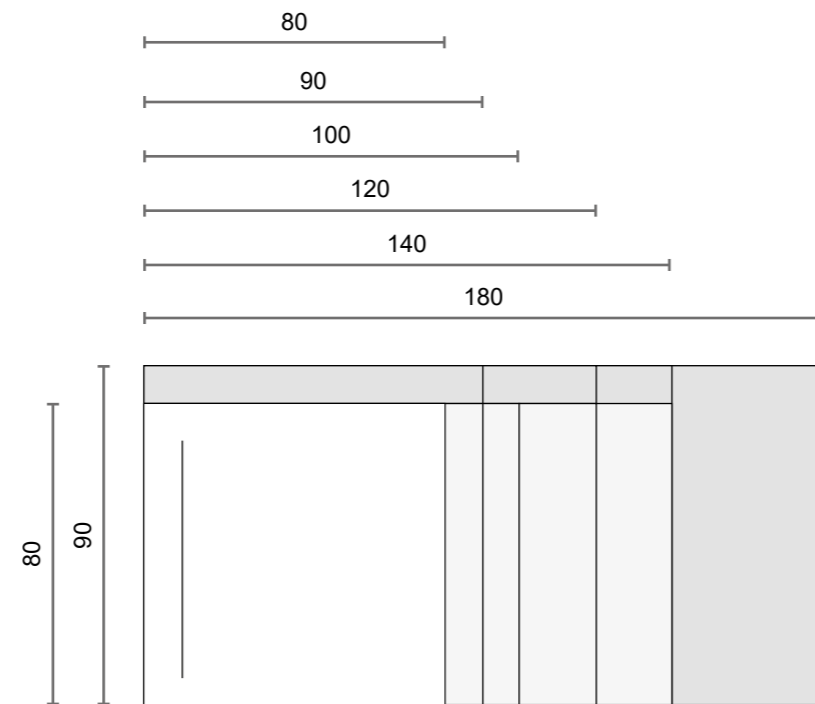

484



| CODICE <i>Code - Artikel - Article</i> | Formato (cm) <i>Size - Format - Dimension</i> | Spessore (cm) <i>Thickness - Stärke - Épaisseur</i> | Prezzo (€) <i>Price - Preis - Prix</i> |
|--|---|---|--|
| LPDQ3 80SL | 80 x 80 | 3,0 | 349,00 |
| LPDQ3 90SL | 90 x 90 | 3,0 | 397,00 |
| LPDR3 810SL | 80 x 100 | 3,0 | 422,00 |
| LPDR3 820SL | 80 x 120 | 3,0 | 475,00 |
| LPDR3 840SL | 80 x 140 | 3,0 | 625,00 |
| LPDR3 880SL | 80 x 180 | 3,0 | 734,00 |
| LPDR3 920SL | 90 x 120 | 3,0 | 570,00 |
| LPDR3 940SL | 90 x 140 | 3,0 | 686,00 |

Il prezzo è riferito al piatto completo di piletta e copripiletta (33 L/Min).
Drain and drain cover included (33 liter/minute).
Ab- und Überlaufgarnitur im Preis inbegriffen (33 L/Minute).
Le prix correspond au receveur avec bonde (33 l/min) et grille d'évacuation incluses.

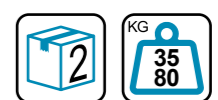

485

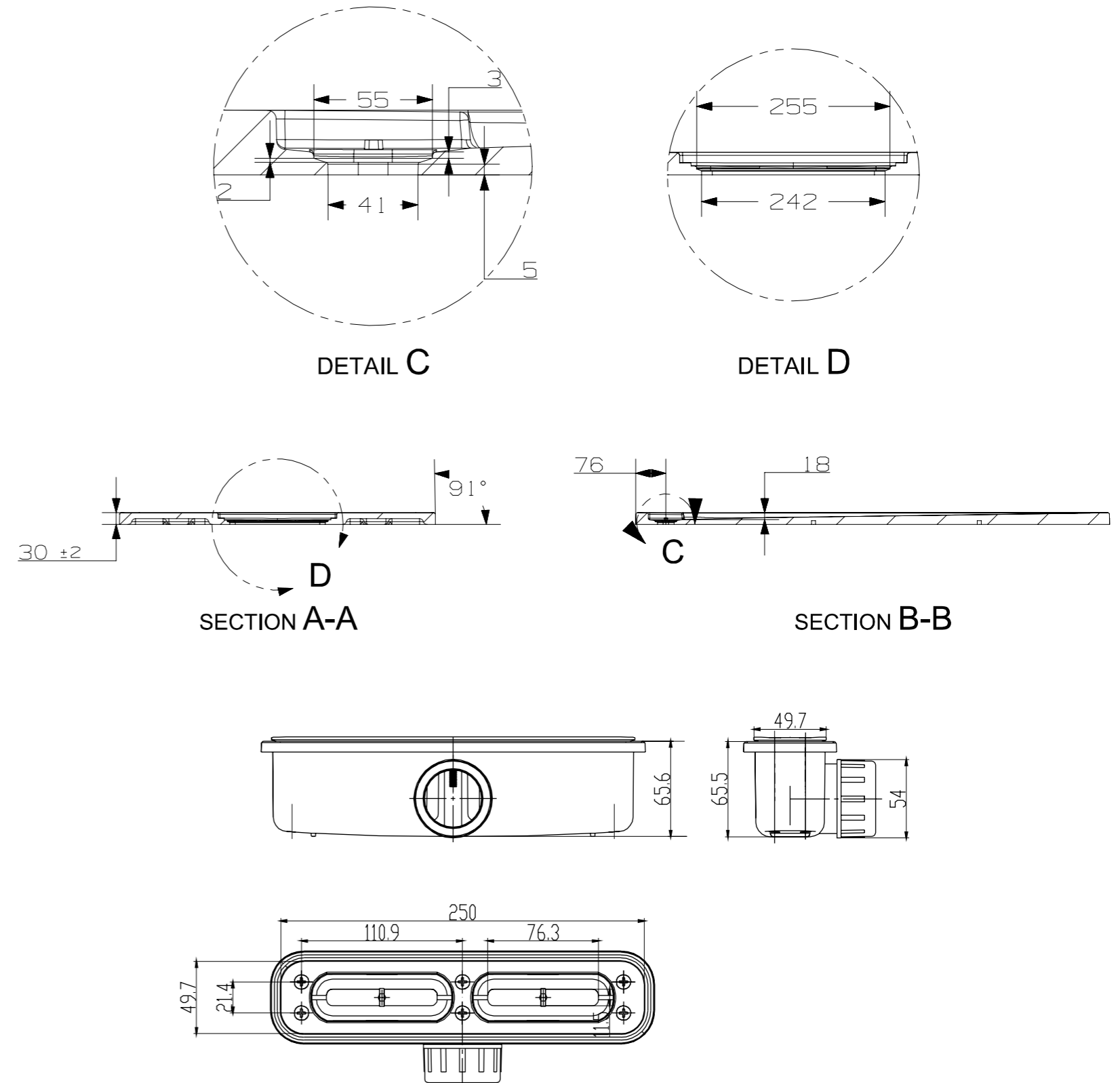
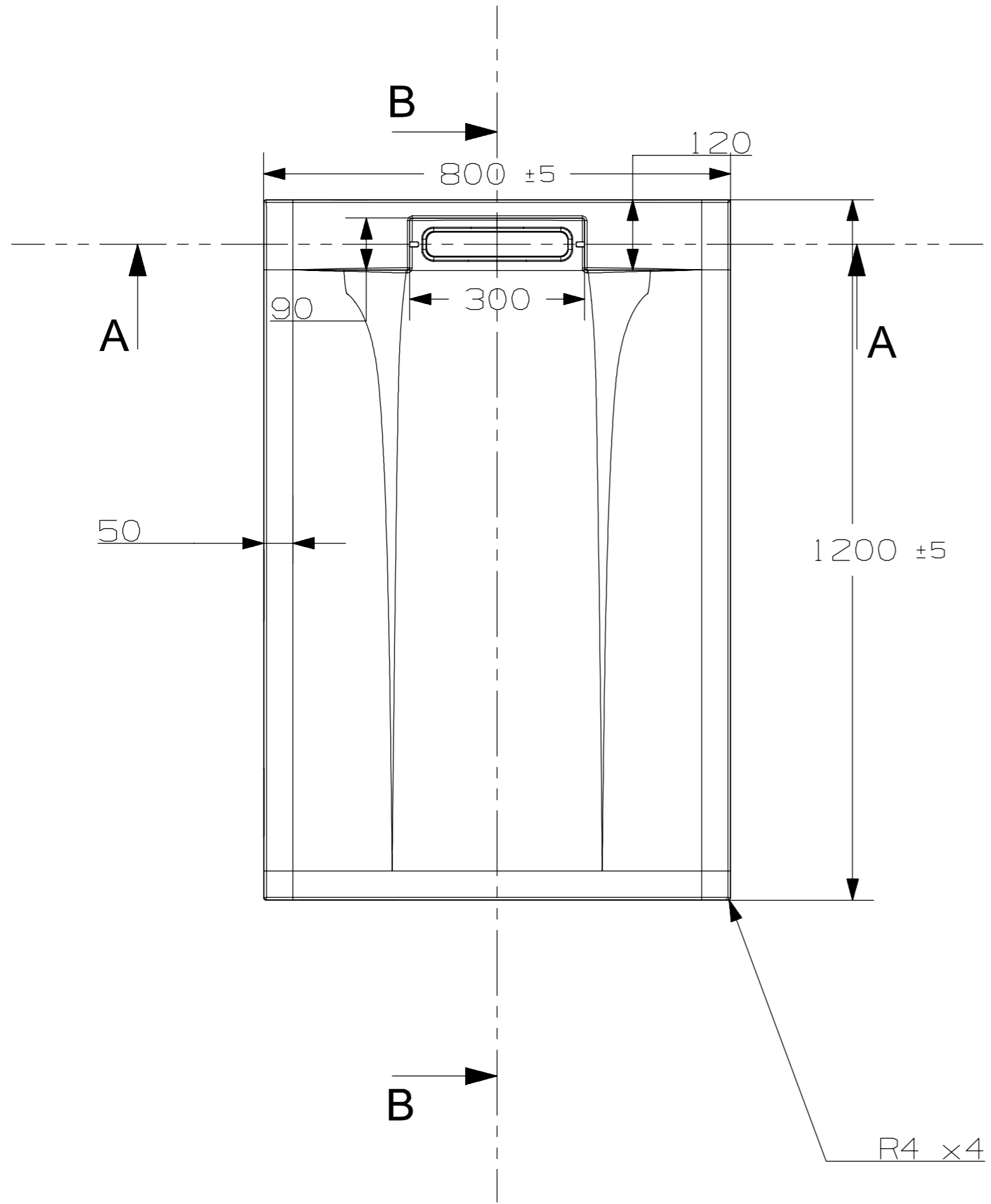

CARATTERISTICHE GENERALI

- Realizzati in S.M.C. Sheet Moulding Compounds (vetroresina).
- Spessore cm 3,5.
- Colore bianco.
- Superficie calpestio liscia e antiscivolo.
- Tubo scarico universale non incluso.
- Piletta di scarico e copripiletta in dotazione (33 L/Min).
- Imballo in scatola di cartone.
- Resistenti ai raggi ultravioletti.

GENERAL CHARACTERISTICS

- Made of S.M.C. Sheet Moulding Compounds (fiberglass).
- 3,5-cm thick.
- White colour.
- Smooth and antislip surface.
- Universal waste pipe not supplied.
- Drain and drain cover included (33 liter/minute).
- Packed in cardboard box.
- UV-resistant

ALLGEMEINE EIGENSCHAFTEN

- Aus Kunststoff (SMC) Sheet Moulding Compounds (Fiberglass).
- Stärke 3,5 cm.
- Weiß.
- Glatte und rutschfeste Oberfläche.
- Universelle Abwasserleitung in Preis nicht inbegriffen.
- Ab- und Überlaufgarnitur im Preis inbegriffen (33 L/Minute).
- Verpackung in Pappkarton.
- UV-beständig

SPECIFICATIONS GENERALES

- Fabriqués en SMC résine polyester (fibre de verre).
- Epaisseur 3,5 cm.
- Le corps du receveur est blanc.
- Texture polie et antidérapante.
- Flexible d'évacuation non fourni.
- Bonde (33 l/min) et grille d'évacuation incluses.
- Conditionnement boîte de carton.
- Résistant aux rayons ultra-violets.

Dall'unione fra tecnologia e semplicità nasce l'eleganza di Slim.

La collezione di piatti doccia Slim di Lacus. Una gamma completa di forme e dimensioni, per le esigenze più diverse.

Facilità di installazione e grande comfort sono le caratteristiche più apprezzate.

Slim elegance springs from the blending of technology and simplicity.

Slim Shower Trays Collection by Lacus.

A full range of shapes and sizes for every different need.

Easy installation and great comfort are the most appreciated features.

Aus der Vereinigung von Technologie und Einfachheit entsteht die Eleganz der Linie SLIM.

Die Duschtassen-Kollektion SLIM von Lacus.

Eine komplette Auswahl Formen und Dimensionen, für die unterschiedlichsten Bedürfnisse.

Einfache Installation und hoher Komfort sind die beliebtesten Eigenschaften.

L'élégance de Slim naît de l'union entre la technologie et la simplicité.

La collection de receveurs de douche Slim de Lacus.

Une gamme complète de formes et de dimensions, pour les besoins les plus différents.

Simplicité d'installation et grand confort sont les caractéristiques les plus appréciées.



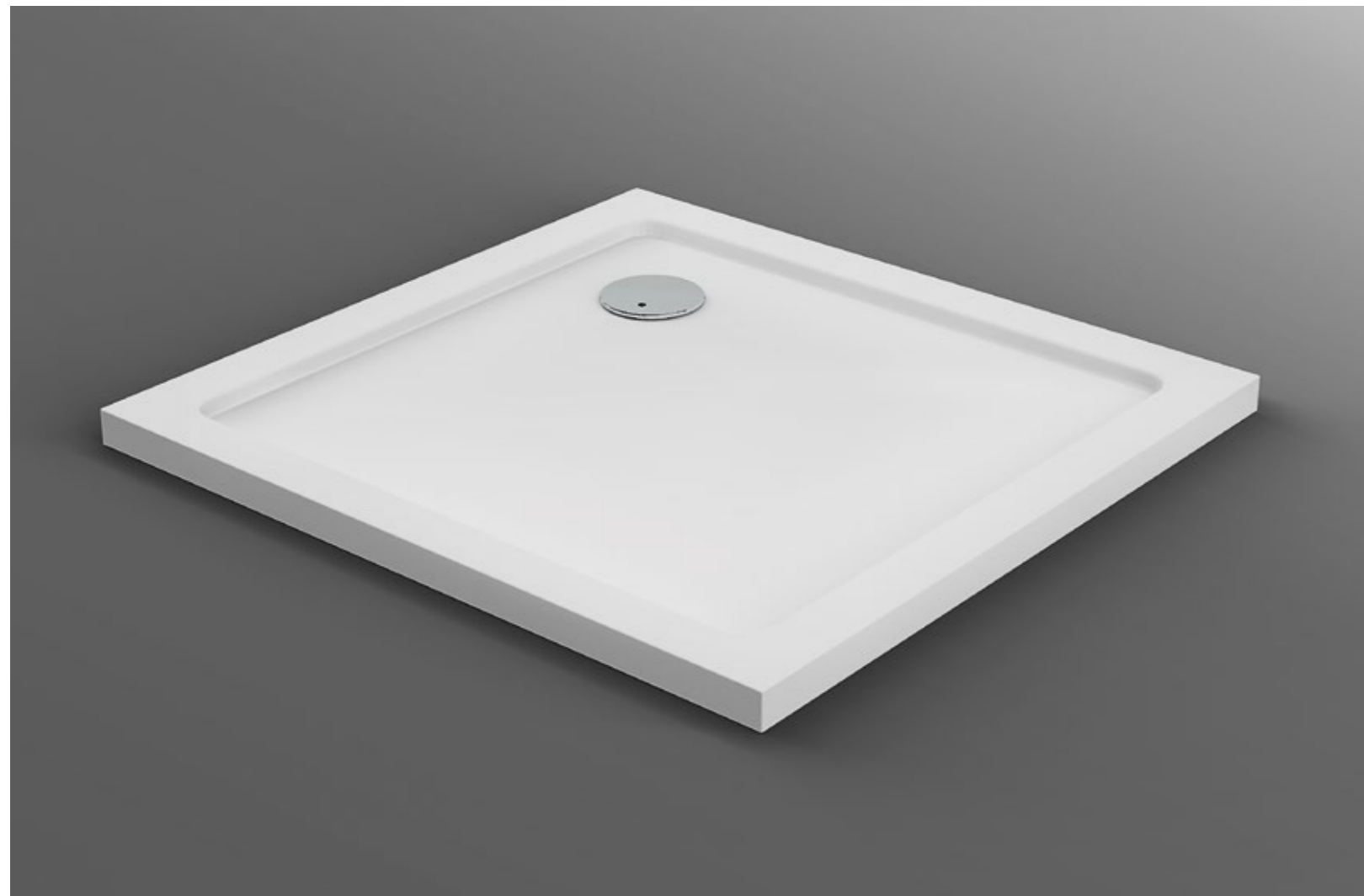

Superficie calpestio liscia e antiscivolo.
Smooth and antislip surface.
Glatte und rutschfeste Oberfläche.
Texture polie et antidérapante.

| CODICE <small>Code - Artikel - Article</small> | Formato (cm) <small>Size - Format - Dimension</small> | Spessore (cm) <small>Thickness - Stärke - Épaisseur</small> | Prezzo (€) <small>Price - Preis - Prix</small> |
|---|--|--|---|
| LPDQ4 76 | 76 x 76 | 3,5 | 236,00 |
| LPDQ4 80 | 80 x 80 | 3,5 | 251,00 |
| LPDQ4 90 | 90 x 90 | 3,5 | 331,00 |
| LPDQ4 100 | 100 x 100 | 3,5 | 371,00 |

Il prezzo è riferito al piatto completo di piletta e copripiletta (33 L/Min).
Drain and drain cover included (33 liter/minute).
Ab- und Überlaufgarnitur im Preis inbegriffen (33 L/Minute).
Le prix correspond au receveur avec bonde (33 l/min) et grille d'évacuation incluses.

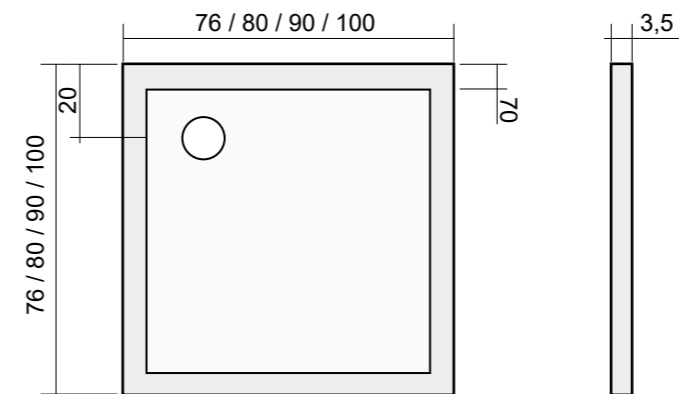



Superficie calpestio liscia e antiscivolo.
Smooth and antislip surface.
Glatte und rutschfeste Oberfläche.
Texture polie et antidérapante.

| CODICE <small>Code - Artikel - Article</small> | Formato (cm) <small>Size - Format - Dimension</small> | Spessore (cm) <small>Thickness - Stärke - Épaisseur</small> | Prezzo (€) <small>Price - Preis - Prix</small> |
|---|--|--|---|
| LPDR4 79 | 70 x 90 | 3,5 | 251,00 |
| LPDR4 710 | 70 x 100 | 3,5 | 269,00 |
| LPDR4 720 | 70 x 120 | 3,5 | 303,00 |
| LPDR4 7670 | 76 x 170 | 3,5 | 440,00 |
| LPDR4 810 | 80 x 100 | 3,5 | 303,00 |
| LPDR4 820 | 80 x 120 | 3,5 | 330,00 |
| LPDR4 840 | 80 x 140 | 3,5 | 398,00 |
| LPDR4 870 | 80 x 170 | 3,5 | 506,00 |
| LPDR4 920 | 90 x 120 | 3,5 | 371,00 |

Il prezzo è riferito al piatto completo di piletta e copripiletta (33 L/Min). - Drain and drain cover included (33 liter/minute).
Ab- und Überlaufgarnitur im Preis inbegriffen (33 L/Minute). - Le prix correspond au receveur avec bonde (33 l/min) et grille d'évacuation incluses.

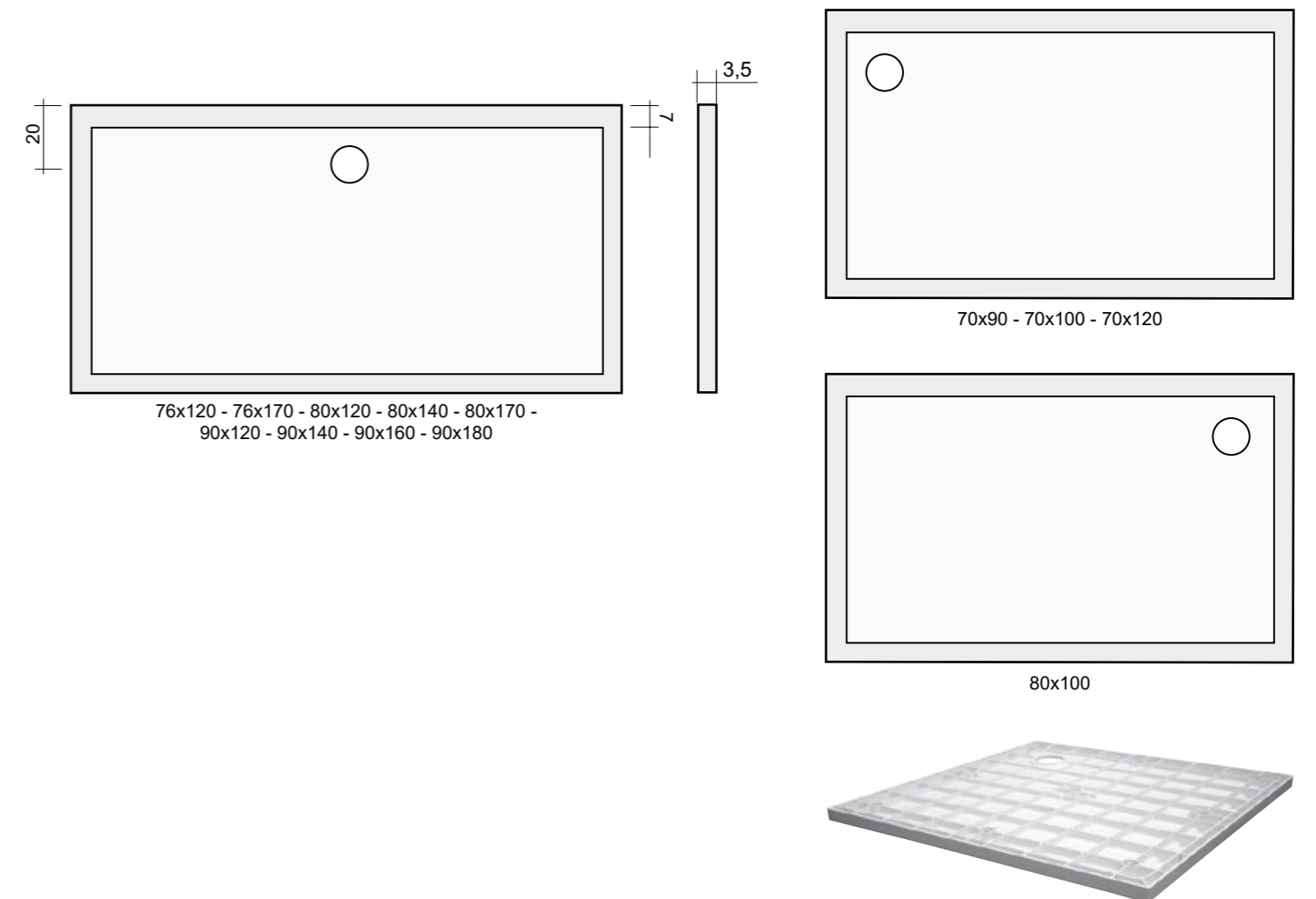

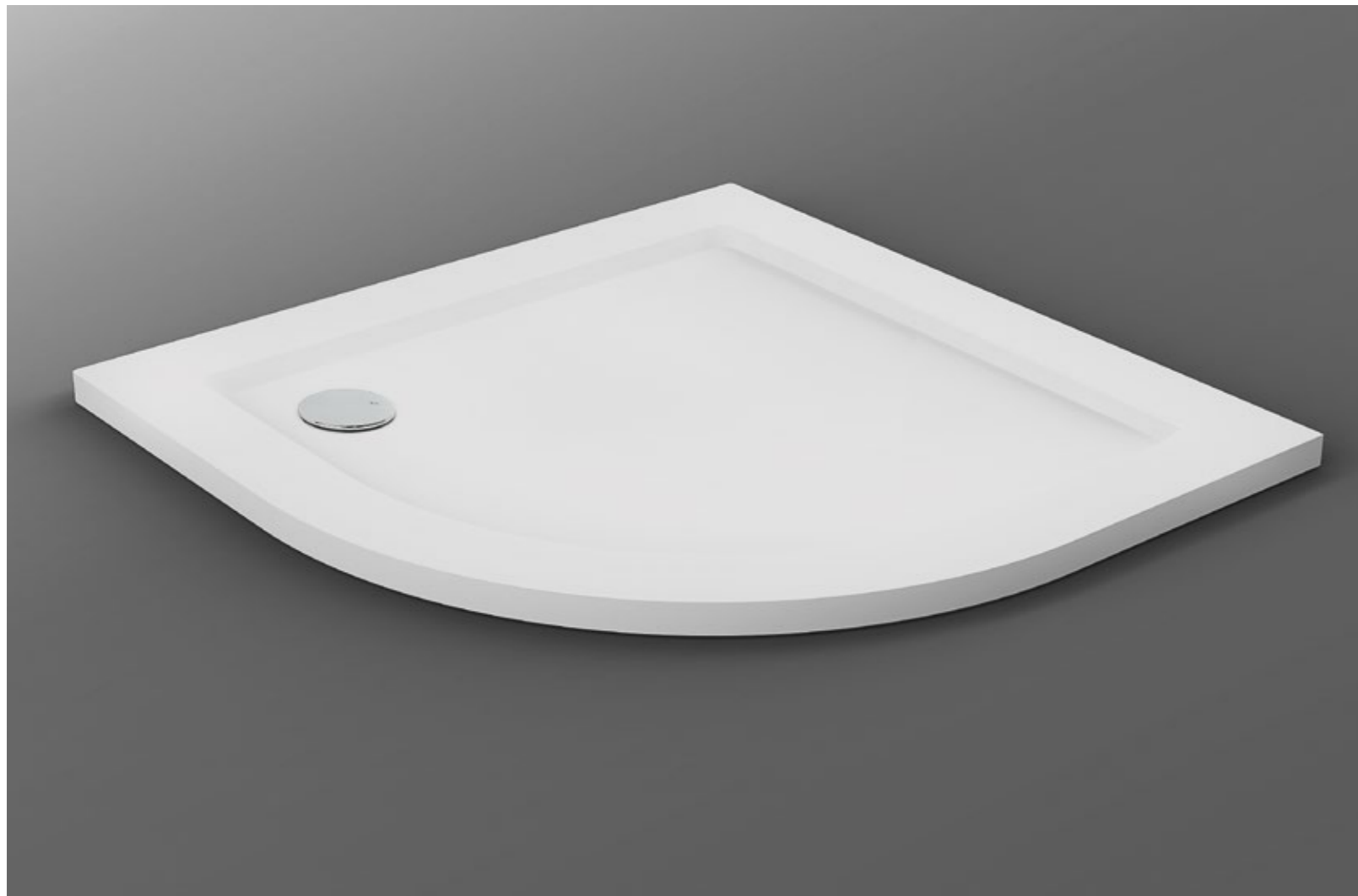

Superficie calpestio liscia e antiscivolo.
Smooth and antislip surface.
Glatte und rutschfeste Oberfläche.
Texture polie et antidérapante.

| CODICE <small>Code - Artikel - Article</small> | Formato (cm) <small>Size - Format - Dimension</small> | Spessore (cm) <small>Thickness - Stärke - Épaisseur</small> | Prezzo (€) <small>Price - Preis - Prix</small> | *R <small>(cm)</small> |
|---|--|--|---|---------------------------|
| LPDS4 80 | 80 x 80 | 3,5 | 247,00 | 55 |
| LPDS4 90 | 90 x 90 | 3,5 | 281,00 | 55 |

Il prezzo è riferito al piatto completo di piletta e copripiletta (33 L/Min).
Drain and drain cover included (33 liter/minute).
Ab- und Überlaufgarnitur im Preis inbegriffen (33 L/Minute).
Le prix correspond au receveur avec bonde (33 l/min) et grille d'évacuation incluses.

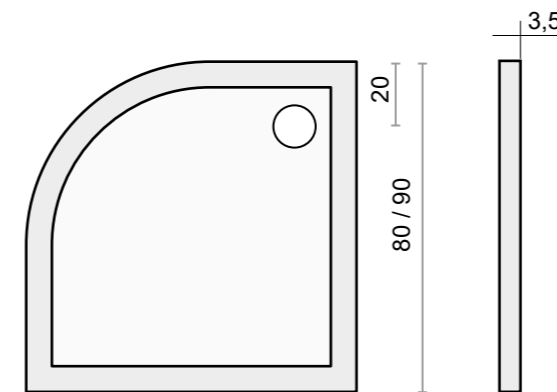

PIATTI DOCCIA SLIM E PANNELLI ISPEZIONABILI

SHOWER TRAYS SLIM AND OPENING PANELS.
DUSCHTASSEN SLIM UND BESICHTIGBARE PANELEN.
RECEVEUR SLIM SURÉLEVÉ ET PANNEAUX CONTRÔLABLES.

| CODICE <i>Code - Artikel - Article</i> | SET PER MODELLO <i>Set for model - Set für Modell - Set pour modèle</i> | PANNELLI <i>Panel - Panele - Panneaux</i> | PIEDINI <i>Feet - Füsse - Pieds</i> | PREZZO (€) <i>Price Preis - Prix</i> |
|---|--|--|--|---|
| LPAN 90 | LPDQ476 - LPDQ480 - LPDQ490 | 2 | | 90,00 |
| LPAN 100 | LPDQ4100 | 2 | | 95,00 |
| LPAN 79 | LPDR479 | 2 | | 90,00 |
| LPAN 7620 | LPDR47620 | 2 | | 97,00 |
| LPAN 810 | LPDR4710 - LPDR4810 | 2 | | 90,00 |
| LPAN 820 | LPDR4720 - LPDR4820 | 2 | | 99,00 |
| LPAN 840 | LPDR4840 | 2 | | 101,00 |
| LPAN 870 | LPDR47670 - LPDR4870 | 2 | | 106,00 |
| LPAN S 90 | LPDS4 80 - LPDS4 90 | 1 | | 77,00 |
| LPIED 9 | LPDQ476 - LPDQ480 - LPDQ490 - LPDR479 | | 9 | 53,00 |
| LPIED 12 | LPDR4710 - LPDR4810 - LPDR4720 - LPDR47620 - LPDR4820 - LPDR4920 | | 12 | 65,00 |
| LPIED 15 | LPDR4840 - LPDR4940 - LPDQ4100 | | 15 | 72,00 |
| LPIED 18 | LPDR47670 - LPDR4960 - LPDR4980 - LPDR4980 | | 18 | 88,00 |
| LPIED 8 | LPDS480 - LPDS490 | | 8 | 51,00 |

Altezza: 10 cm. - Height: 10 cm. - Höhe: 10 Cm. - Hauteur: 10 cm.

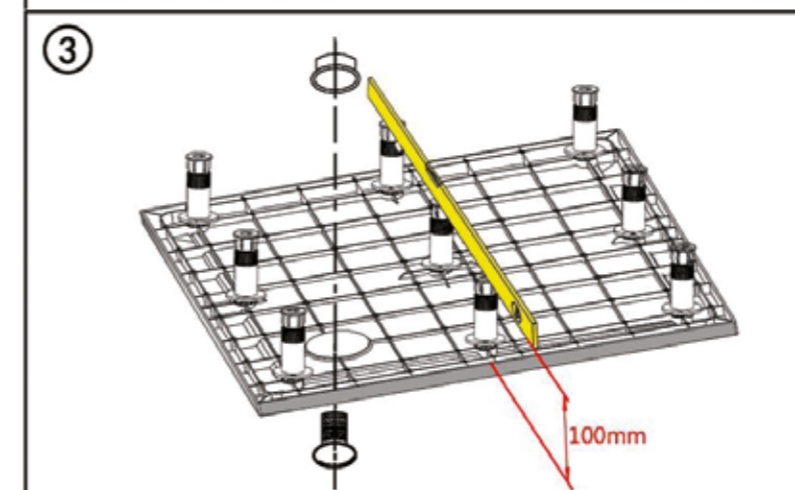
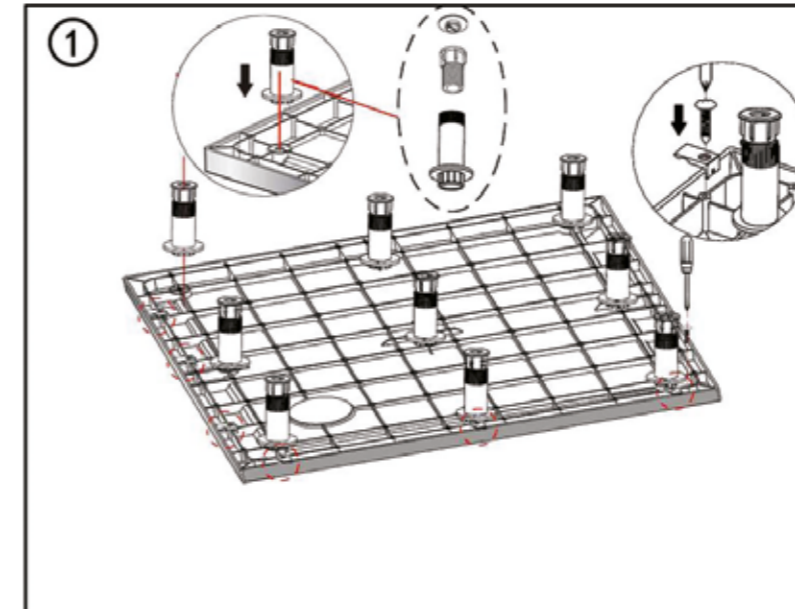

Rimuovere la pellicola protettiva di plastica dalla zona vicino lo scarico e dai lati del piatto che batteranno a muro. Posizionare lo scarico doccia. Tutti i piedini dovrebbero essere regolati ad un'altezza di 100mm.
Remove protective plastic film from the areas near waste and those sides of the tray which will be against the wall. Fit the shower tray waste. All feet should be adjusted to 100mm.

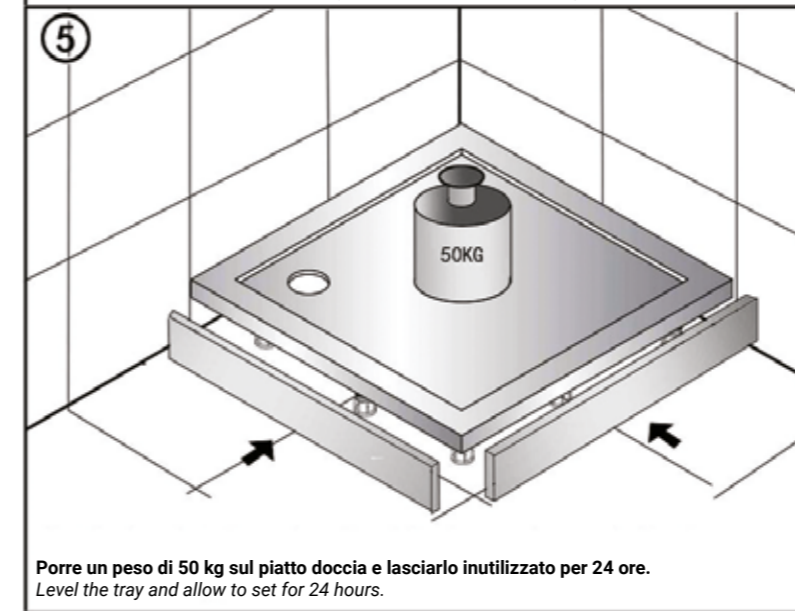

Porre un peso di 50 kg sul piatto doccia e lasciarlo inutilizzato per 24 ore.
Level the tray and allow to set for 24 hours.

2) Stellen Sie sicher, dass die Lage der Duschtasse fest, eben und sauber ist.
Assurez-vous que la place pour le receveur soit ferme, plane et propre.

3) Entfernen Sie die Schutzfolie aus dem Auspuff und von den Mauerseiten. Legen Sie den Ablauf ein. Die "Füße" sollten bis zu einer Höhe von 100 mm eingestellt werden.
Retirez le film protecteur autour de l'évacuation et sur les côtés du receveur qui seront contre le mur. Insérez la bonde. Réglez les pieds à une hauteur de 100 mm.

4) Setzen Sie die Tasse in Position und heben Sie beide Seiten mit den Füßen. Planieren Sie die Tasse und die Füße. Kleben Sie die Füße auf den Boden mit Silikon.
Mettez le receveur en place et surélevez les deux côtés avec les pieds. Nivelez le receveur et les pieds. Collez les pieds sur le sol avec de la silicone.

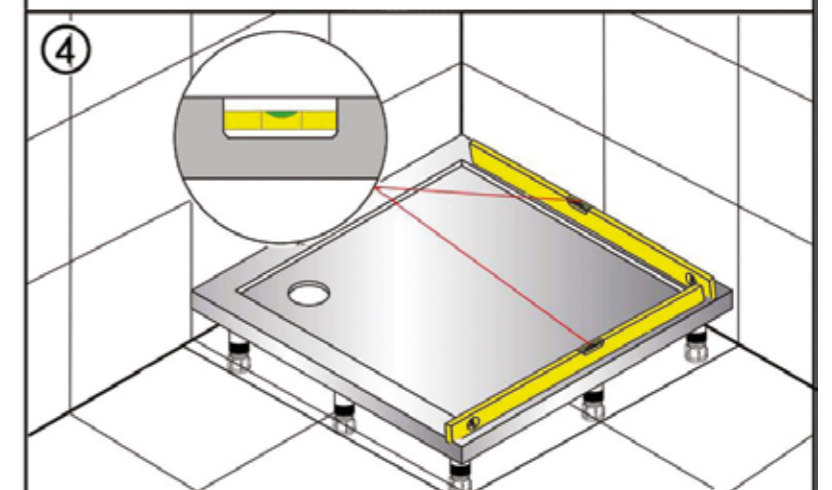
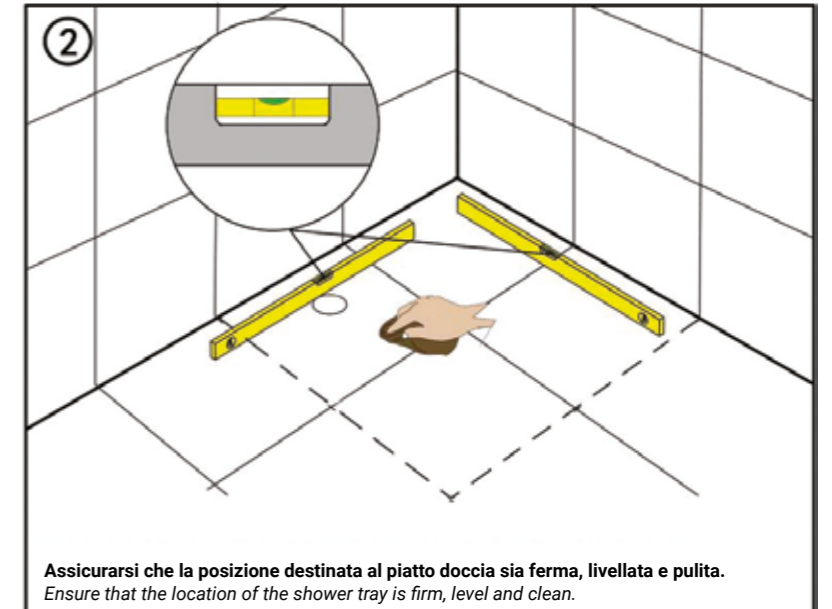

Assicurarsi che la posizione destinata al piatto doccia sia ferma, livellata e pulita.
Ensure that the location of the shower tray is firm, level and clean.

Mettere il piatto in posizione e sollevare entrambi i lati usando i piedini. Livellare piatto e piedini. Una volta finito incollare i piedini al pavimento con del silicone sigillante.
Place the tray into position and set on level both ways using the feet. After the tray has been leveled adjust all the inner feet to stabilize the tray. When on level, fix the feet to the floor with silicon sealant.

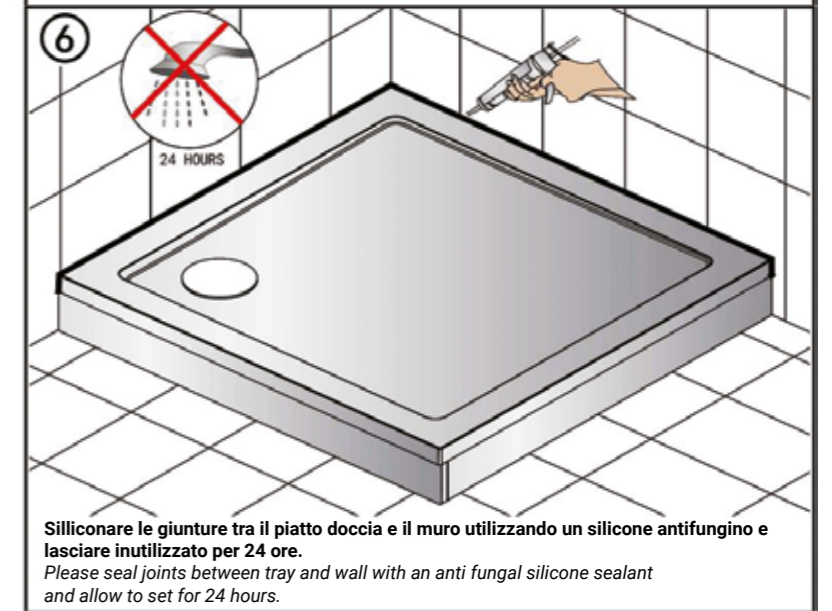

Siliconare le giunture tra il piatto doccia e il muro utilizzando un silicone antifungino e lasciarlo inutilizzato per 24 ore.
Please seal joints between tray and wall with an anti fungal silicone sealant and allow to set for 24 hours.

5) Legen Sie ein Gewicht von 50 kg für 24 Stunden auf die Duschtasse.
Placez un poids de 50 kg sur le receveur et laissez-le stabiliser pendant 24 heures.

6) Benutzen Sie antimykotische Silikon zwischen Duschtasse und Wand und lassen Sie für 24 Stunden.
Appliquez de la silicone antimoisissure sur les joints entre le receveur de douche et le mur et laissez sécher pendant 24 heures.

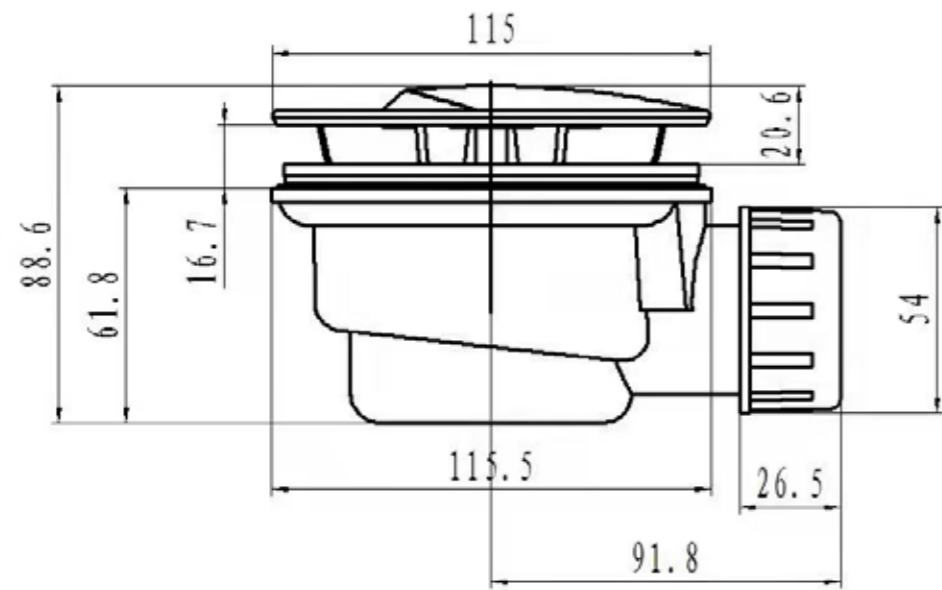
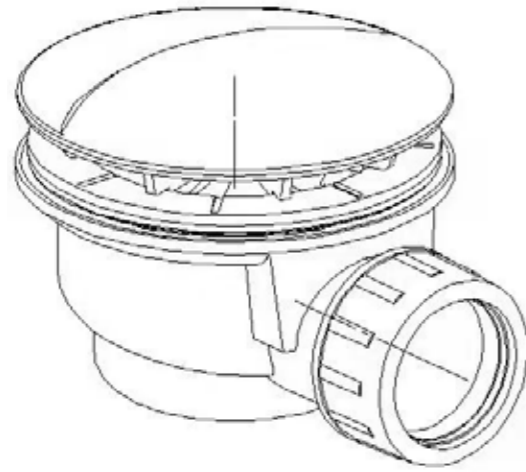

- Piletta Standard in dotazione ai piatti doccia Slim -
- Standard drain included (Shower trays "Slim") -
- Standard Ablaufgarnitur für die Serie Slim. Im Preis inbegriffen -
- Bonde standard incluse pour les receveurs «Slim» -

LPDQ4

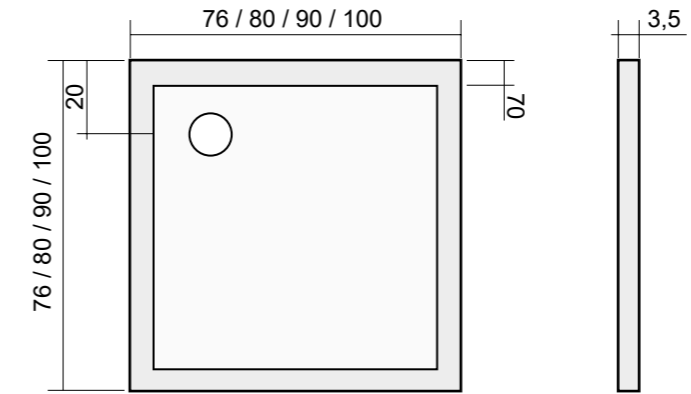

LPDS4

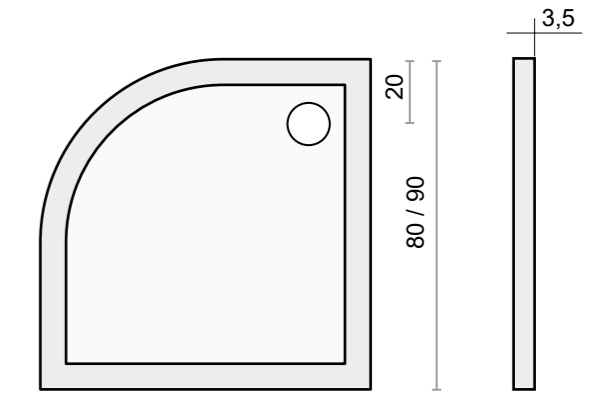

LPDR4

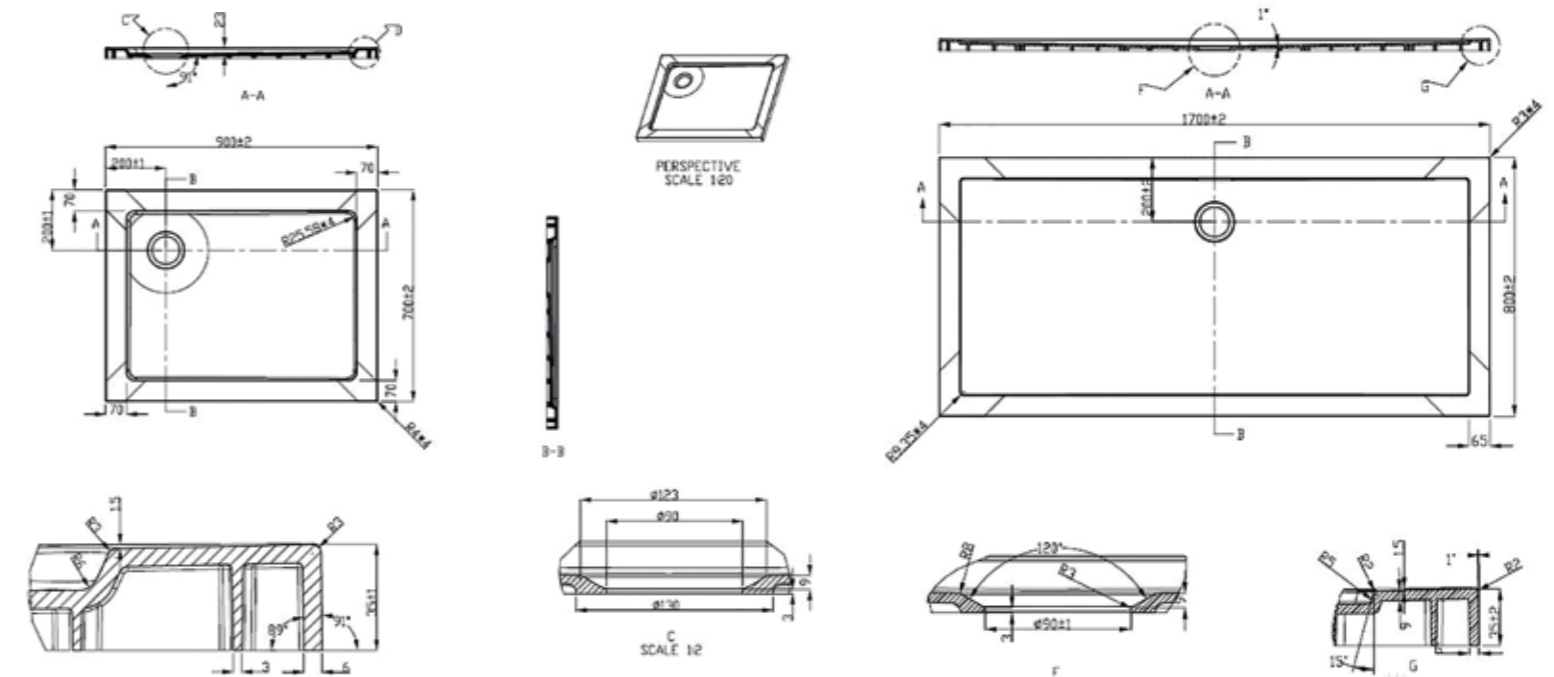

DA VASCA IN DOCCIA SLIM

FROM BATHTUB TO SHOWER SLIM.
VON BADEWANNE ZUR SLIM DUSCHE.
DE LA BAIGNOIRE À LA DOUCHE SLIM.



FASI DI LAVORAZIONE:

1. Rimuovere la vasca.
2. Predisporre gli scarichi e la piletta.
3. Posizionare il piatto doccia Lpdr4 Slim.
4. Rilevare le misure liberate dalla vasca.
5. Tagliare il pannello LVD 680 sulla misura del lato lungo.
6. Tagliare il pannello LVD 610 sulla misura del lato corto.
7. Posizionare i pannelli LVD con collanti epossidici o poliuretanicici da piastrella.
8. Procedere con l'installazione del box doccia.

STEPS:

1. Remove the tube.
2. To establish the drains and the drain.
3. Place the shower tray Lpdr4 Slim.
4. Determine dimensions leaved by the tube.
5. Cut LVD 680 panel on the long side.
6. Cut LVD 610 panel on the short side.
7. Place the panels LVD with epoxy or Polyurethane adhesive for the tiles.
8. Install the shower enclosure.

BEARBEITUNGSSCHRITTE:

1. Badewanne abnehmen.
2. Abwasserleitung und Ablaufgarnitur aufstellen.
3. Die Duschtasse LPDR4 Slim einlegen.
4. Die von der Badewanne freigelassene Fläche gut ausmessen.
5. Brett LVD 680 auf der langen Seite nach Maß zuschneiden.
6. Brett LVD 610 auf der kürzen Seite nach Maß zuschneiden.
7. Die Bretter durch Epoxydharz- oder Polyurathankleber kleben.
8. Die Duschkabine aufbauen.

ETAPES DE TRAITEMENT:

1. Démontez la baignoire.
2. Préparez le flexible d'évacuation et la bonde.
3. Placez le receveur Lpdr4 Slim.
4. Déterminez les dimensions de la surface découverte du mur.
5. Coupez le panneau LVD680 sur la longueur.
6. Coupez le panneau LVD610 sur la largeur.
7. Placez les panneaux LVD avec des colles époxy ou polyuréthane pour les carreaux.
8. Montez la cabine de douche.



PIATTI DOCCIA
SHOWER TRAYS

In poche ore! - In a few hours! - In wenigen Stunden! - En quelques heures!

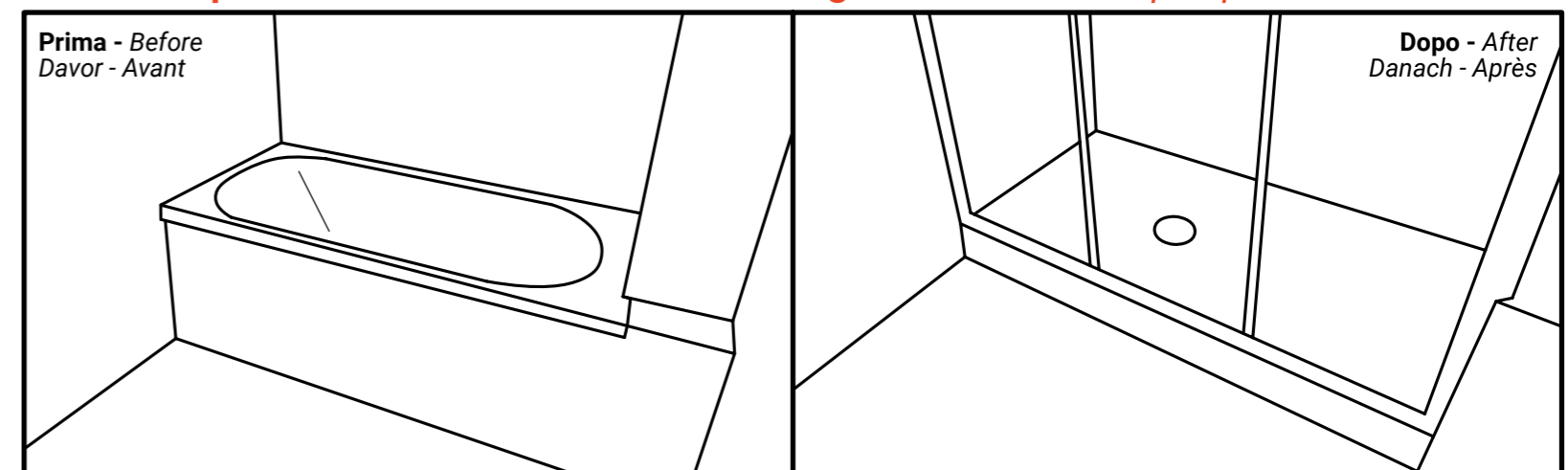

-MADE IN ITALY-

| Codice Code - Artikel - Article | Formato (cm) Size - Format - Dimension | Spessore (cm) Thickness - Stärke - Épaisseur | Prezzo (€) Price - Preis - Prix |
|------------------------------------|---|---|------------------------------------|
| LVD 610 | 80 x 100 | 0,3 | 548,00 |
| LVD 680 | 80 x 180 | 0,3 | 915,00 |

Pannelli prefiniti in resina su supporto in Dibond. Colorazione abbinata al piatto doccia Slim.
Panels prefinished resin on support Dibond. Color matched to the shower tray Slim.
Vorbearbeitete Harzbrett auf Dibondfolie. Die Farbe passt die Duschtasse der Serie Slim.
Panneaux préfinis en résine sur support Dibond. Couleur assortie au receveur Slim.

COLONNE DOCCIA

SHOWER COLUMNS

DUSCHPANEELE UND DUSCHSÄULE

COLONNES DE DOUCHE

CARATTERISTICHE GENERALI

- Realizzati interamente in Acciaio Inox 304, Alluminio e Ottone cromato 800/1000.
- Superfici cromate, spazzolate e laccate.
- Predisposizione per collegamento alla rete idrica.
- Pressione ottimale 2,5 bar.
- Nessun ausilio di pompe idriche.
- Spessori da 1,2 a 4 mm.
- Doccetta a mano con flessibile.

GENERAL CHARACTERISTICS

- Made entirely of stainless steel 304, aluminium and brass 800/1000.
- Chrome, brushed burnished, lacquered.
- Ready for water supply connection.
- Optimal pressure 2.5 Bar.
- No use of water pumps.
- 1,2/4 Mm thickness.
- Hand shower with flexible hose.

TECHNISCHE EIGENSCHAFTEN

- Aus rostfreiem Stahl 304, Aluminium und Verchromtem Messing 800/1000.
- Verchromte, gebürstete und satinierte Oberflächen.
- Für den Anschluss an das Wassernetz vorbereitet.
- Optimaler Druck 2.5 bar.
- Keine Wasserpumphilfe.
- Stärke 1,2/4 mm.
- Handbrause mit Schlauch.

SPECIFICATIONS GENERALES

- Fabriquées entièrement en acier inoxydable 304, aluminium et laiton chromé 800/1000.
- Texture chromée, brossée et laquée.
- Prêtes pour l'installation au réseau d'eau.
- Pression minimale nécessaire 2.5 bars.
- Aucun besoin de pompes hydrauliques.
- Épaisseur de 1,2 à 4 mm.
- Ensemble douchette et flexible.





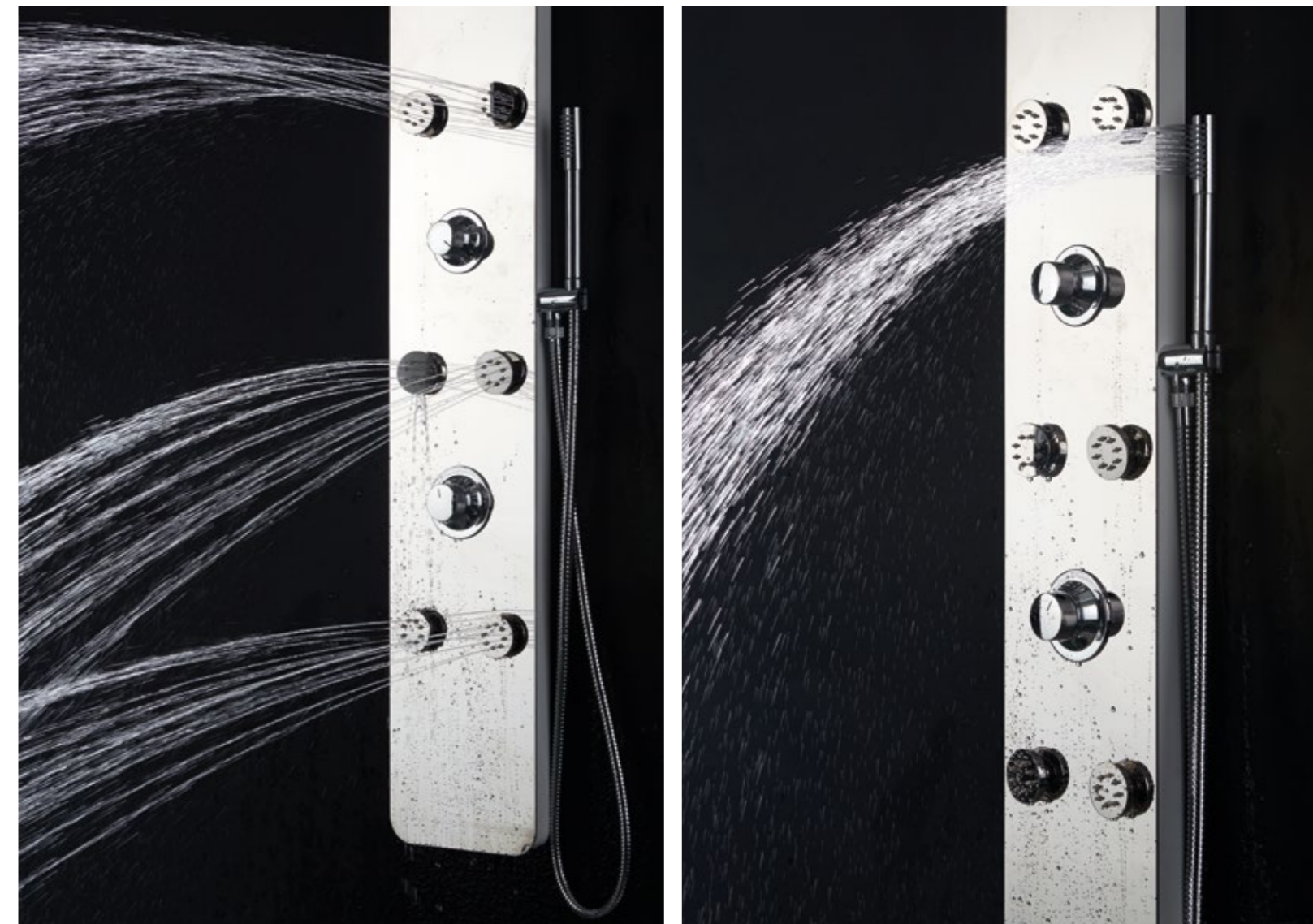

| CODICE Code - Artikel - Article | Formato (cm) Size - Format - Dimension | Prezzo (€) Price - Preis - Prix |
|---|--|---|
| LCDA 144C | 144 x 20 x 49 x 4,7 | 1.112,00 |

CARATTERISTICHE DELLA COLONNA DOCCIA

- 6 getti d'acqua orientabili.
- Doccetta in ottone cromato.
- Pannello in acciaio inossidabile 1,2 mm.
- Rubinetto in ottone.
- Flessibile in PVC.
- Miscelatore con cartuccia progressiva.
- Deviatore a 3 vie.

SHOWER COLUMN CHARACTERISTICS

- 6 steerable jets.
- Chrome-plated brass hand shower.
- 1,2 mm thick stainless steel panel.
- Shower arm and faucet: brass.
- PVC Hose.
- Progressive cartridge mixer.
- 3 way diverter.

EIGENSCHAFTEN DES DUSCHPANEELS

- 6 bewegliche Düsen.
- Verchromte Handbrause aus Messing.
- 1,2 mm stark Brett aus rostfreiem Stahl.
- Hahn aus Messing.
- Schlauch aus PVC.
- Progressiver Kartuschenmischer.
- 3-Wege-Umsteller.

SPECIFICATIONS DES COLONNES DE DOUCHE

- 6 jets orientables.
- Douchette à main en laiton chromé.
- Panneau en acier inoxydable de 1,2 mm.
- Mitigeur en laiton.
- Flexible en PVC.
- Mitigeur avec cartouche progressive.
- Déviateur à 3 voies.



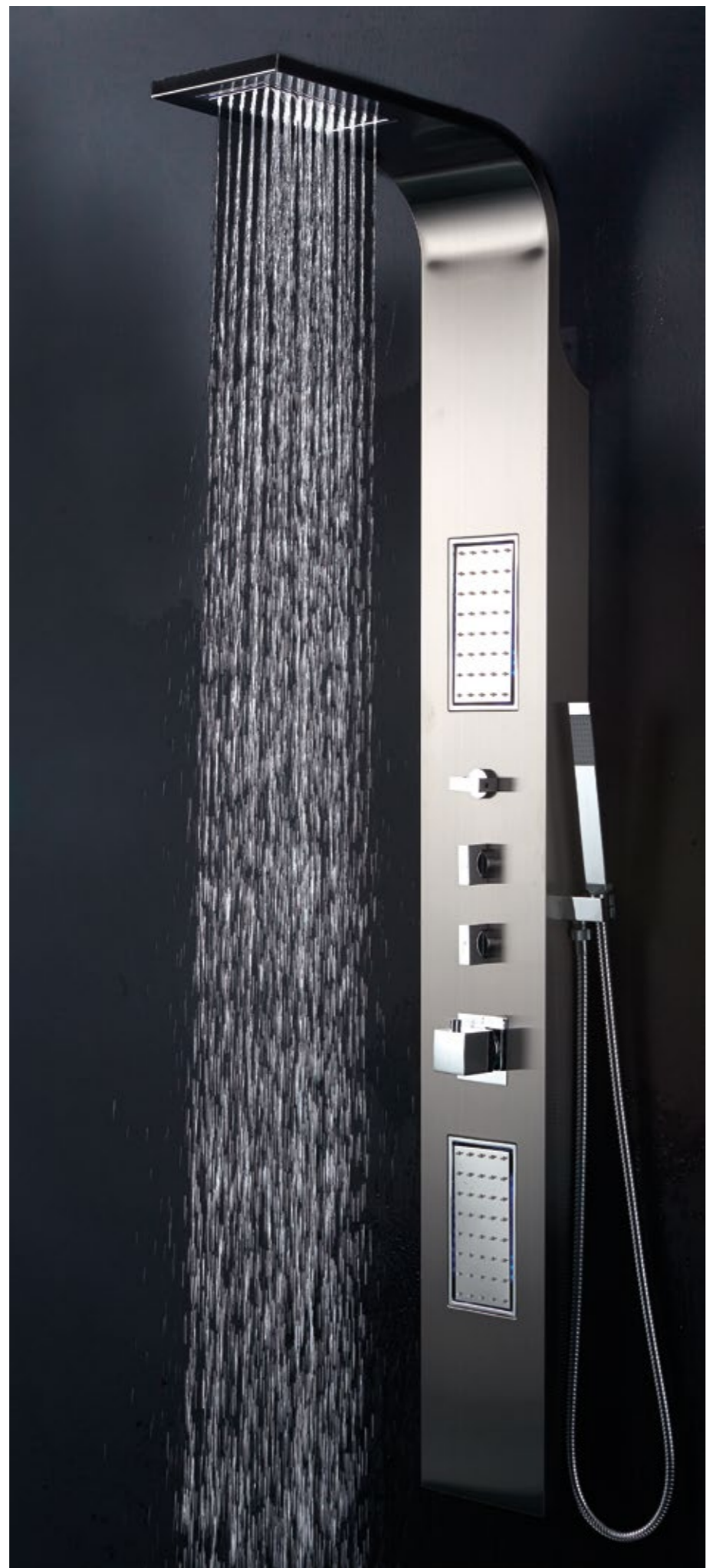

| CODICE <small>Code - Artikel - Article</small> | Formato (cm) <small>Size - Format - Dimension</small> | Prezzo (€) <small>Price - Preis - Prix</small> |
|--|---|--|
| LCDC 166S | 158 x 46 x 19 x 7,5 | 1.258,00 |

CARATTERISTICHE DELLE COLONNE DOCCIA

- 3 getti d'acqua orientabili.
- Doccetta in ottone cromato.
- Pannello in acciaio Inox 304 spazzolato.
- Rubinetto in ottone.
- Flessibile in PVC.
- Miscelatore termostatico.

SHOWER COLUMN CHARACTERISTICS

- 3 steerable jets.
- Chrome-plated brass hand shower.
- Brushed stainless steel 304 body.
- Shower arm and faucet: brass.
- PVC Hose.
- Thermostatic mixer.

EIGENSCHAFTEN DES DUSCHPANEELS

- 3 bewegliche Düsen.
- Verchromte Handbrause aus Messing.
- Brett aus gebürstetem rostfreiem Stahl 304.
- Hahn aus Messing.
- Schlauch aus PVC.
- Thermostat.

SPECIFICATIONS DES COLONNES DE DOUCHE

- 3 jets orientables.
- Douchette à main en laiton chromé.
- Panneau en acier brossé de 1,2 mm.
- Robinet en laiton.
- Flexible en PVC.
- Mitigeur thermostatique.



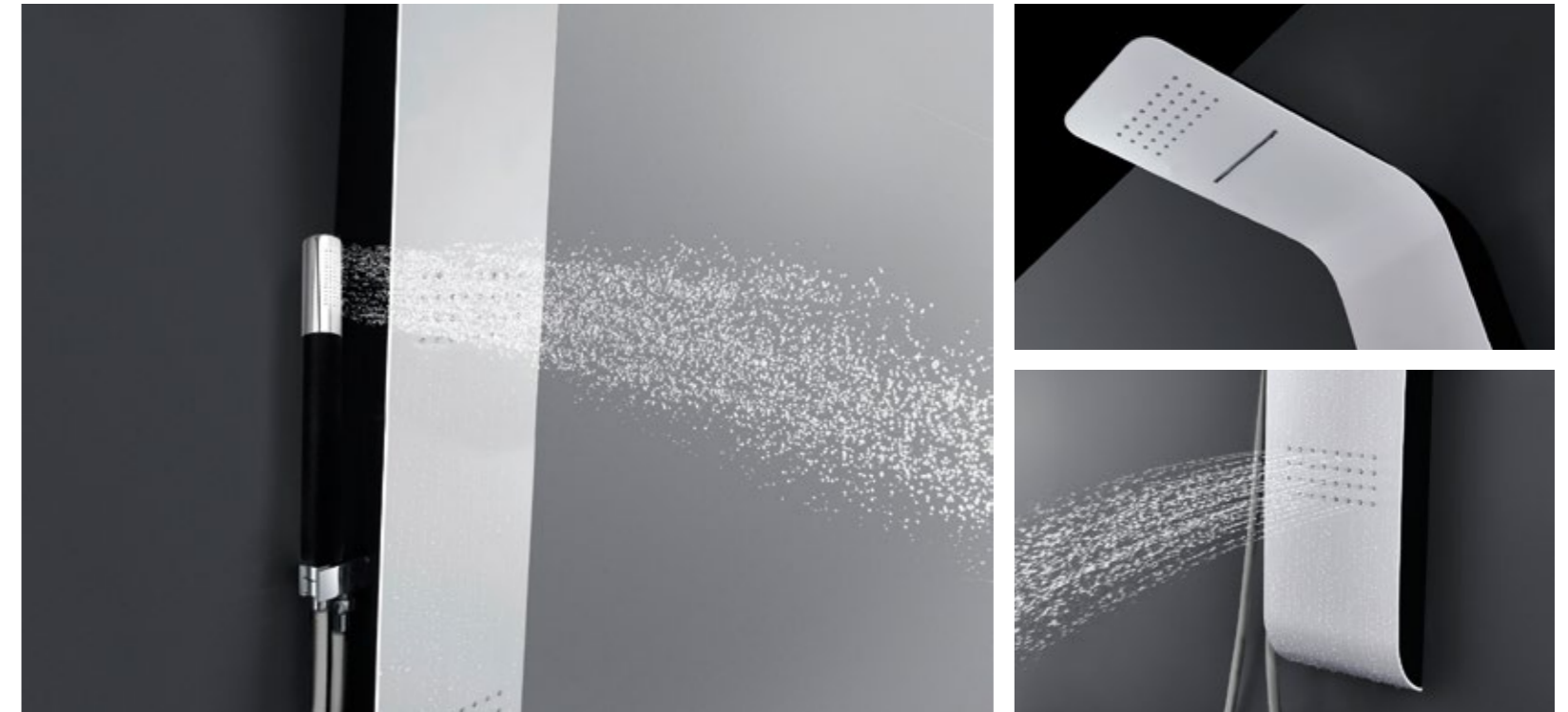

| CODICE <small>Code - Artikel - Article</small> | Formato (cm) <small>Size - Format - Dimension</small> | Prezzo (€) <small>Price - Preis - Prix</small> |
|--|---|--|
| LCD 140 W | 140 x 20 x 46 x 7,5 | 946,00 |

CARATTERISTICHE DELLE COLONNE DOCCIA

- 3 getti d'acqua e cascata.
- Doccetta in ottone cromato.
- Pannello in alluminio laccato bianco.
- Rubinetti in ottone .
- Flessibile in PVC.
- Miscelatore con cartuccia progressiva.
- Deviatore a 4 vie.

SHOWER COLUMN CHARACTERISTICS

- 3 steerable jets and waterfall.
- Chrome-plated brass hand shower.
- 4 mm thick white varnished aluminium panel.
- Shower arm and faucet: brass.
- PVC Hose.
- Progressiver Kartuschenmischer.
- 4 way diverter.

EIGENSCHAFTEN DES DUSCHPANEELS

- 3 Düsen und Wasserfall-effekt.
- Verchromte Handbrause aus Messing
- 4 mm Brett aus satiniertem Aluminium.
- Hahn aus Messing.
- Schlauch aus PVC.
- Progressive cartridge mixer.
- 4 Wege-Umsteller.

SPECIFICATIONS DES COLONNES DE DOUCHE

- 3 jets d'eau et cascade.
- Douchette à main en laiton chromé.
- Panneau en aluminium émaillé blanche.
- Robinets en laiton.
- Flexible en PVC.
- Mitigeur avec cartuche progressive .
- Déviateur à 4 voies.



COLOMBAIA



CARATTERISTICHE DELLE COLONNE DOCCIA

- 3 getti d'acqua.
- Doccetta in ABS antracite.
- Pannello in acciaio inox 304 antracite.
- Miselatore ultra sottile.
- Deviatore a 3 vie.
- Flessibile in PVC.

SHOWER COLUMN CHARACTERISTICS

- 3 jets.
- Hand shower made of PVC Anthracite.
- 304 stainless steel panel Anthracite.
- Ultra thin mixer.
- 3-way diverter.
- Flexible PVC.

EIGENSCHAFTEN DES DUSCHPANEELS

- 3 Düsen.
- Handdusche aus PVC Anthrazit.
- Brett aus gebürstetem rostfreiem Stahl 304 Anthrazit.
- Ultrduenner Mischer.
- 3-Wege mixer.
- Schlauch aus PVC.

SPECIFICATIONS DES COLONNES DE DOUCHE

- 3 jets.
- Douchette anthracite en PVC.
- Panneau en acier anthracite.
- Mischer ultra-mince.
- Deviateur 3 voies.
- Flexible en PVC.



| CODICE Code - Artikel - Article | Formato (cm) Size - Format - Dimension | Prezzo (€) Price - Preis - Prix |
|------------------------------------|---|------------------------------------|
| LCD 130 SG | 130 x 43,5 x 20 x 3 | 822,00 |



PALOMBA



CARATTERISTICHE DELLE COLONNE DOCCIA

- 3 getti d'acqua.
- Doccetta in ottone cromato.
- Pannello in acciaio inox 304 spazzolato.
- Deviatore a 3 vie.
- Flessibile in PVC.

SHOWER COLUMN CHARACTERISTICS

- 3 jets.
- Chrome-plated brass hand shower.
- Brushed stainless steel 304 body.
- 3-way diverter.
- PVC Hose.

EIGENSCHAFTEN DES DUSCHPANEELS

- 3 Düsen.
- Verchromte Handbrause aus Messing.
- Brett aus gebürstetem rostfreiem Stahl 304.
- 3-Wege-Umsteller
- Schlauch aus PVC.

SPECIFICATIONS DES COLONNES DE DOUCHE

- 3 jets.
- Douchette à main en laiton chromé.
- Panneau en acier brossé.
- Deviateur à 3 voies.
- Flexible en PVC.



| CODICE Code - Artikel - Article | Formato (cm) Size - Format - Dimension | Prezzo (€) Price - Preis - Prix |
|------------------------------------|---|------------------------------------|
| LCD 140 SC | 140 x 52 x 22 x 6,5 | 798,00 |



SPARGI



CARATTERISTICHE DELLE COLONNE DOCCIA

- 3 getti d'acqua.
- Doccetta in ottone cromato.
- Pannello in acciaio inossidabile 1,2 mm.
- Rubinetto in ottone.
- Flessibile in PVC.

SHOWER COLUMN CHARACTERISTICS

- 3 jets.
- Chrome-plated brass hand shower.
- 1,2 mm thick stainless steel panel.
- Shower arm and faucet: brass.
- PVC Hose.

LCD 160C
Cromo lucido
Polished Chrome
Poliertes Chrom
Chrome poli



LCD 160S
Acciaio spazzolato
Brushed steel
Gebürsteter Rostfreier Stahl
Acier brossé



LCD 160B
Bianco satinato
Mat white
Weiß satiniert
Blanc satiné



LCD 160N
Nero satinato
Mat black
Schwarz satiniert
Noir Satinée



EIGENSCHAFTEN DES DUSCHPANEELS

- 3 Düsen.
- Verchromte Handbrause aus Messing.
- 1,2 mm stark Brett aus rostfreiem Stahl.
- Hahn aus Messing.
- Schlauch aus PVC.

SPECIFICATIONS DES COLONNES DE DOUCHE

- 3 jets.
- Douchette à main en laiton chromé.
- Panneau en acier inoxydable de 1,2 mm.
- Mitigeur en laiton.
- Flexible en PVC.

| CODICE Code - Artikel - Article | Formato (cm) Size - Format - Dimension | Prezzo (€) Price - Preis - Prix |
|------------------------------------|---|------------------------------------|
| LCD 160C | 160 x 15 x 55 x 6 | 994,00 |

| CODICE Code - Artikel - Article | Formato (cm) Size - Format - Dimension | Prezzo (€) Price - Preis - Prix |
|------------------------------------|---|------------------------------------|
| LCD 160S | 160 x 15 x 55 x 6 | 942,00 |

| CODICE Code - Artikel - Article | Formato (cm) Size - Format - Dimension | Prezzo (€) Price - Preis - Prix |
|------------------------------------|---|------------------------------------|
| LCD 160B | 160 x 15 x 55 x 6 | 967,00 |

| CODICE Code - Artikel - Article | Formato (cm) Size - Format - Dimension | Prezzo (€) Price - Preis - Prix |
|------------------------------------|---|------------------------------------|
| LCD 160N | 160 x 15 x 55 x 6 | 967,00 |



MOLARA



| CODICE <i>Code - Artikel - Article</i> | Formato (cm) <i>Size - Format - Dimension</i> | Prezzo (€) <i>Price - Preis - Prix</i> |
|--|---|--|
| LCD 130 B | 112 x 35,2 x 50 x 8 | 702,00 |

CARATTERISTICHE DELLE COLONNE DOCCIA

- 1 getto d'acqua.
- Doccetta in ottone cromato.
- Pannello in alluminio laccato.
- Rubinetti in ottone.
- Flessibile in PVC.

SHOWER COLUMN CHARACTERISTICS

- 1 steerable jets.
- Chrome-plated brass hand shower.
- Stainless steel panel.
- Shower arm and faucet: brass.
- PVC Hose.

EIGENSCHAFTEN DES DUSCHPANEELS

- 1 Düse.
- Verchromte Handbrause aus Messing.
- Brett aus satiniertem Aluminium.
- Hahn aus Messing.
- Schlauch aus PVC.

SPECIFICATIONS DES COLONNES DE DOUCHE

- 1 jet.
- Douchette à main en laiton chromé.
- Panneau en aluminium laqué.
- Robinets en laiton.
- Flexible en PVC.



GORGONA



| CODICE <small>Code - Artikel - Article</small> | Formato (cm) <small>Size - Format - Dimension</small> | Prezzo (€) <small>Price - Preis - Prix</small> |
|--|---|--|
| LCD 120W | 118 x 13 x 41 x 7 | 535,00 |

CARATTERISTICHE DELLE COLONNE DOCCIA

- 3 getti d'acqua.
- Doccetta in ottone cromato.
- Pannello in alluminio laccato bianco e alluminio cromo.
- Rubinetto in ottone cromato.
- Flessibile in PVC.

SHOWER COLUMN CHARACTERISTICS

- 3 jets.
- Chrome-plated brass hand shower.
- White varnished and chrome plated aluminium panel.
- Shower arm and faucet: brass.
- PVC Hose.



| CODICE <small>Code - Artikel - Article</small> | Formato (cm) <small>Size - Format - Dimension</small> | Prezzo (€) <small>Price - Preis - Prix</small> |
|--|---|--|
| LCD 120C | 118 x 13 x 41 x 7 | 535,00 |

EIGENSCHAFTEN DES DUSCHPANEELS

- 3 Düsen.
- Verchromte Handbrause aus Messing.
- Brett aus weiß-satiniert- oder verchromtem Aluminium.
- Hahn aus Messing.
- Schlauch aus PVC.

SPECIFICATIONS DES COLONNES DE DOUCHE

- 3 jets.
- Douchette à main en laiton chromé.
- Panneau en aluminium émaillé blanc et en aluminium chromé.
- Robinet en laiton chromé.
- Flexible en PVC.



SAN NICOLA



CARATTERISTICHE COLONNA DOCCIA

- Corpo principale in ottone cromato.
- Miscelatore in ottone.
- Intersezione 15 cm.

SHOWER COLUMN CHARACTERISTICS

- Chrome-plated main body.
- Mixer: brass.
- Intersection 15 cm.

EIGENSCHAFTEN DES DUSCHPANEELS

- Grundkörper aus verchromtem Messing.
- Brausebatterie aus Messing.
- 15 cm Schnitt.

SPECIFICATIONS DE LA COLONNE DE DOUCHE

- Corps principal en laiton chromé.
- Mitigeur en laiton.
- Intersection de 15 cm.

***Abbinare i soffioni da pg. 532 a pg. 547 e le doccette con flessibile di pg. 550, 551 e 553.**

**Match the showerheads (from page 532 to page 547) and hand showers page 550, 551 and 553.*

**Passen Sie die Köpfe von Seite 532 bis Seite 547 und Handbrausen mit Schlauch Seite 550, 551, 553 an.*

**Assortir aux douches de tête (voir de p. 532 à p. 547) et aux douchettes avec flexible (voir p. 550, 551, 553).*

*** Il prezzo della colonna è privo di soffione, doccetta e flessibile.**

** The price of the column has no shower head, hand shower and flexible.*

** Der Preis von der Duschsäule rechnet keinen Duschkopf, keine Handbrause und keinen Schlauch mit.*

** Le prix de la douche de tête, de la douchette à main et du flexible ne sont pas inclus dans le prix de la colonne.*

| CODICE Code - Artikel - Article | Formato (cm) Size - Format - Dimension | Formato (cm) Size - Format - Dimension | Prezzo (€) Price - Preis - Prix |
|------------------------------------|---|--|------------------------------------|
| LCDQ 140 | 105/140 x 40 x 15 | Colonna doccia Quadrata - Square shower column Viereckige Duschsäule - Colonne carrée | 735,00 |

SAN DOMINO



CARATTERISTICHE COLONNA DOCCIA

- Corpo principale in ottone cromato.
- Miscelatore termostatico in ottone.
- Intersezione 15 cm.

SHOWER COLUMN CHARACTERISTICS

- Chrome-plated main body.
- Brass thermostatic mixer.
- Intersection 15 cm.

EIGENSCHAFTEN DES DUSCHPANEELS

- Grundkörper aus verchromtem Messing.
- Thermostatbatterie aus Messing.
- 15 cm Schnitt.

SPECIFICATIONS DE LA COLONNE DE DOUCHE

- Corps principal en laiton chromé.
- Mitigeur thermostatique en laiton.
- Intersection de 15 cm.

***Abbinare i soffioni da pg. 532 a pg. 547 e le doccette con flessibile di pg. 550, 551 e 553.**

**Match the showerheads (from page 532 to page 547) and hand showers page 550, 551 and 553.*

**Passen Sie die Köpfe von Seite 532 bis Seite 547 und Handbrausen mit Schlauch Seite 550, 551, 553 an.*

**Assortir aux douches de tête (voir de p. 532 à p. 547) et aux douchettes avec flexible (voir p. 550, 551, 553).*

*** Il prezzo della colonna è privo di soffione, doccetta e flessibile.**

** The price of the column has no shower head, hand shower and flexible.*

** Der Preis von der Duschsäule rechnet keinen Duschkopf, keine Handbrause und keinen Schlauch mit.*

** Le prix de la douche de tête, de la douchette à main et du flexible ne sont pas inclus dans le prix de la colonne.*

| CODICE Code - Artikel - Article | Formato (cm) Size - Format - Dimension | Formato (cm) Size - Format - Dimension | Prezzo (€) Price - Preis - Prix |
|------------------------------------|---|--|------------------------------------|
| LCDT01 120 | 90/140 x 40 x 15 | Colonna doccia tonda - Round shower column runde Duschsäule - Colonne ronde | 525,00 |





CARATTERISTICHE COLONNA DOCCIA

- Corpo principale in ottone cromato.
- Miscelatore termostatico in ottone.
- Intersezione 15 cm.

SHOWER COLUMN CHARACTERISTICS

- Chrome-plated main body.
- brass thermostatic mixer.
- Intersection 15 cm.

EIGENSCHAFTEN DES DUSCHPANEELS

- Grundkörper aus verchromtem Messing.
- Thermostatbatterie aus Messing.
- 15 cm Schnitt.

SPECIFICATIONS DE LA COLONNE DE DOUCHE

- Corps principal en laiton chromé.
- Mitigeur thermostatique en laiton.
- Intersection de 15 cm.

***Abbinare i soffioni da pg. 532 a pg. 547 e le doccette con flessibile di pg. 550, 551 e 553.**

**Match the showerheads (from page 532 to page 547) and hand showers page 550, 551 and 553.*

**Passen Sie die Köpfe von Seite 532 bis Seite 547 und Handbrausen mit Schlauch Seite 550, 551, 553 an.*

**Assortir aux douches de tête (voir de p. 532 à p. 547) et aux douchettes avec flexible (voir p. 550, 551, 553).*

*** Il prezzo della colonna è privo di soffione, doccetta e flessibile.**

** The price of the column has no shower head, hand shower and flexible.*

** Der Preis von der Duschsäule rechnet keinen Duschkopf, keine Handbrause und keinen Schlauch mit.*

** Le prix de la douche de tête, de la douchette à main et du flexible ne sont pas inclus dans le prix de la colonne.*

| CODICE Code - Artikel - Article | Formato (cm) Size - Format - Dimension | Descrizione Description - Beschreibung - Description | Prezzo (€) Price - Preis - Prix |
|------------------------------------|---|--|------------------------------------|
| LCDQ 100T | 100 x 40,5 x 15 | Colonna doccia Quadrata - Square shower column Viereckige Duschsäule - Colonne carrée | 603,00 |

ACCIAIO INOX

STEINLESS STEEL
ROSTFREIER STAHL
ACIER INOXYDABLE

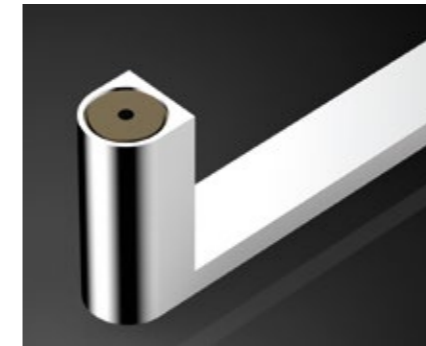

Porta doccetta in ottone cromato.
Shower holder of chromed brass
Haltung für die Handbrause aus verchromtem Messing.
Porte-douchette en laiton chromé.

OTTONE CROMATO

CHROME PLATED BRASS
VERCHROMTES MESSING
LAITON CHROMÉ

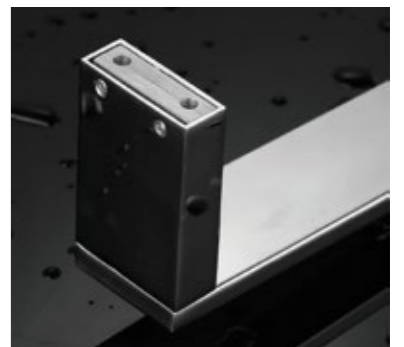

| CODICE Code - Artikel - Article | Formato (cm) Size - Format - Dimension | Descrizione Description - Beschreibung - Description | Prezzo (€) Price - Preis - Prix |
|------------------------------------|---|--|------------------------------------|
| LSX 70 | 3 X 68 | Saliscendi in acciaio Inox. Wall bar in stainless steel. Brausenstange aus rostfreiem Stahl. Barre de douche avec curseur en acier inoxydable. | 124,00 |
| LSOT 80 | 4 X 80 | Saliscendi in ottone cromato. Wall bar in chrome plated brass. Brausenstange aus verchromtem Messing. Barre de douche avec curseur en laiton chromé. | 204,00 |



DISEGNI TECNICI COLONNE DOCCIA

TECHNICAL DRAWING SHOWER COLUMNS
 TECHNISCHE ZEICHNUNG DER DUSCHSÄULE
 DESSIN TECHNIQUE DES COLONNES DE DOUCHE

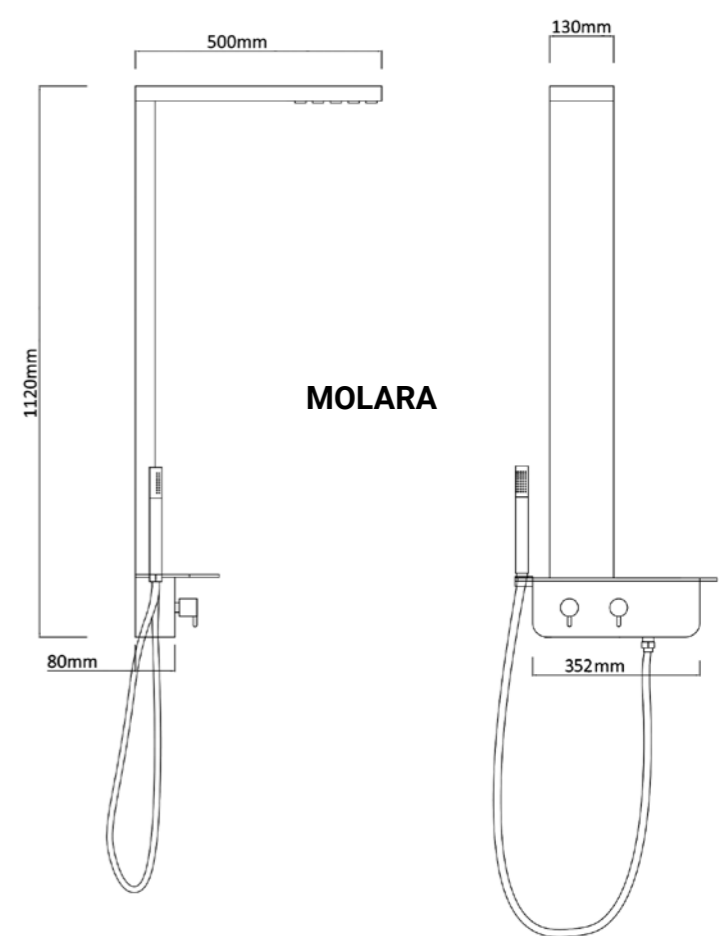
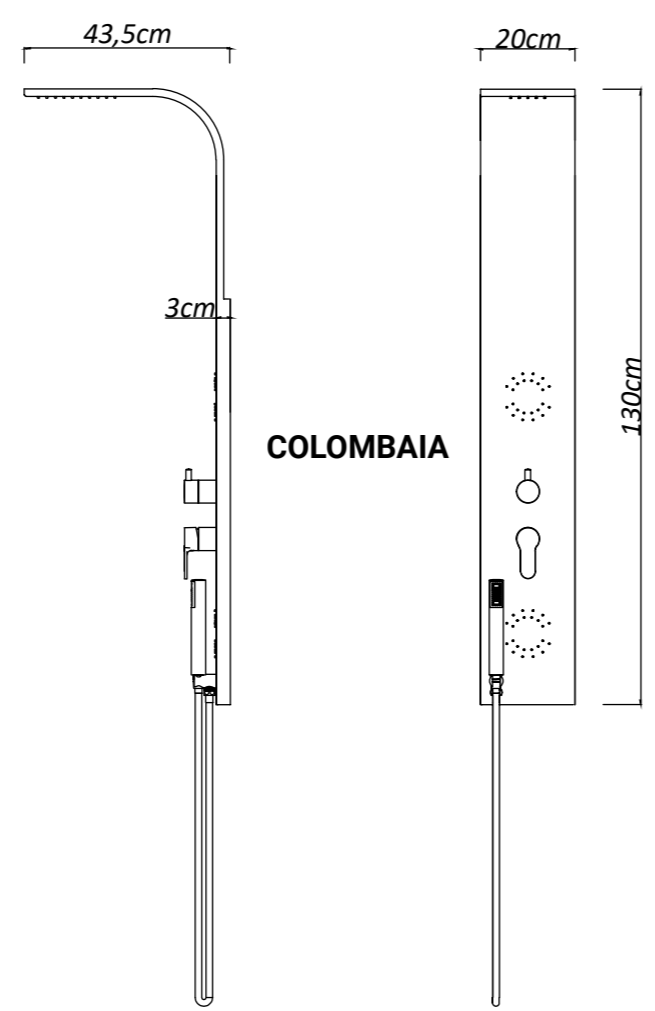
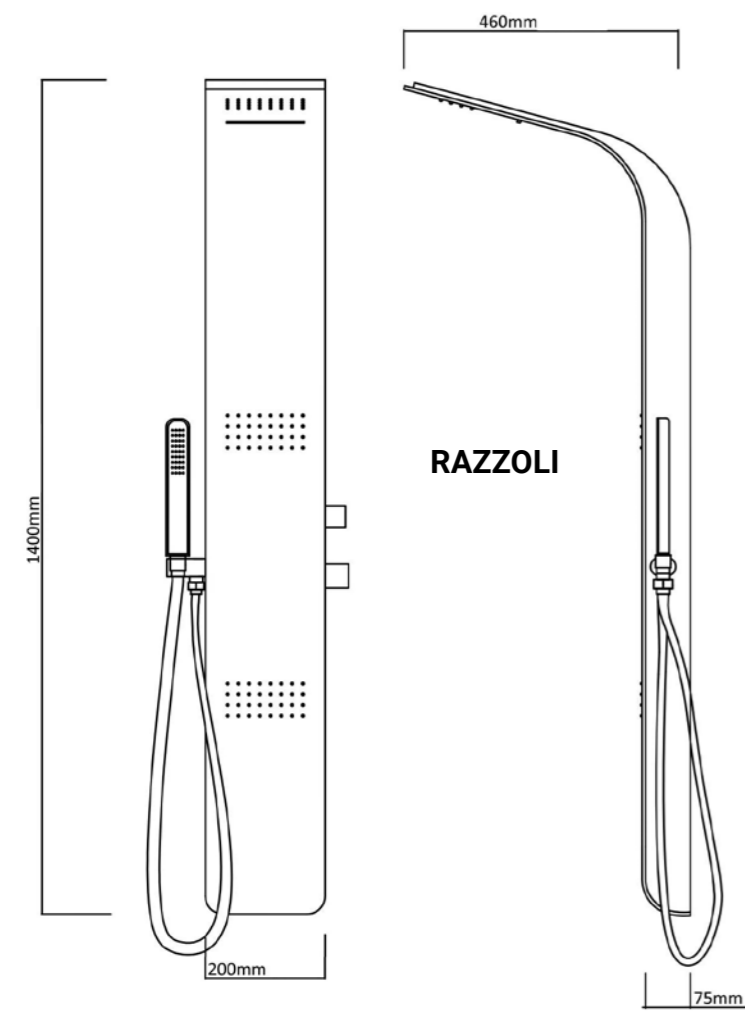
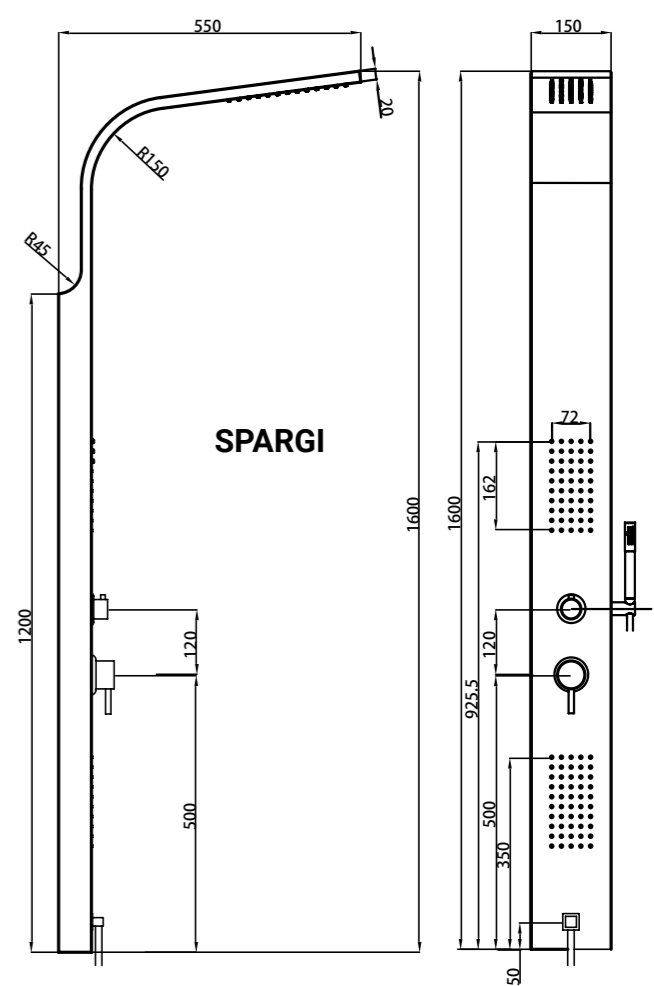
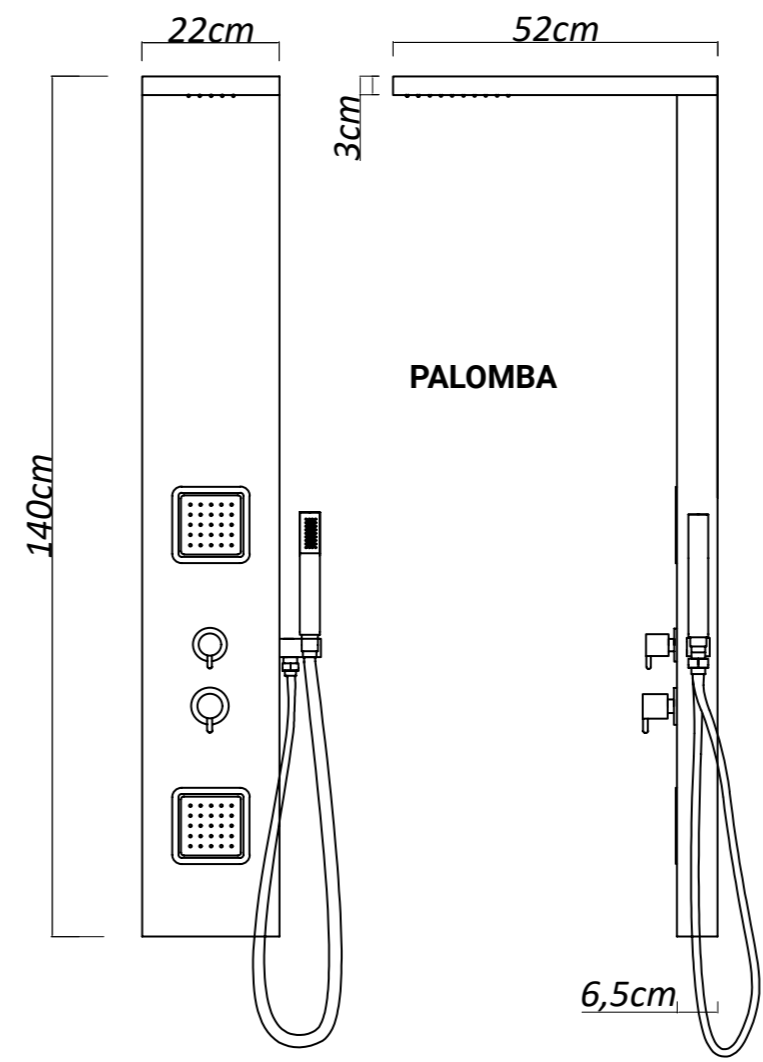
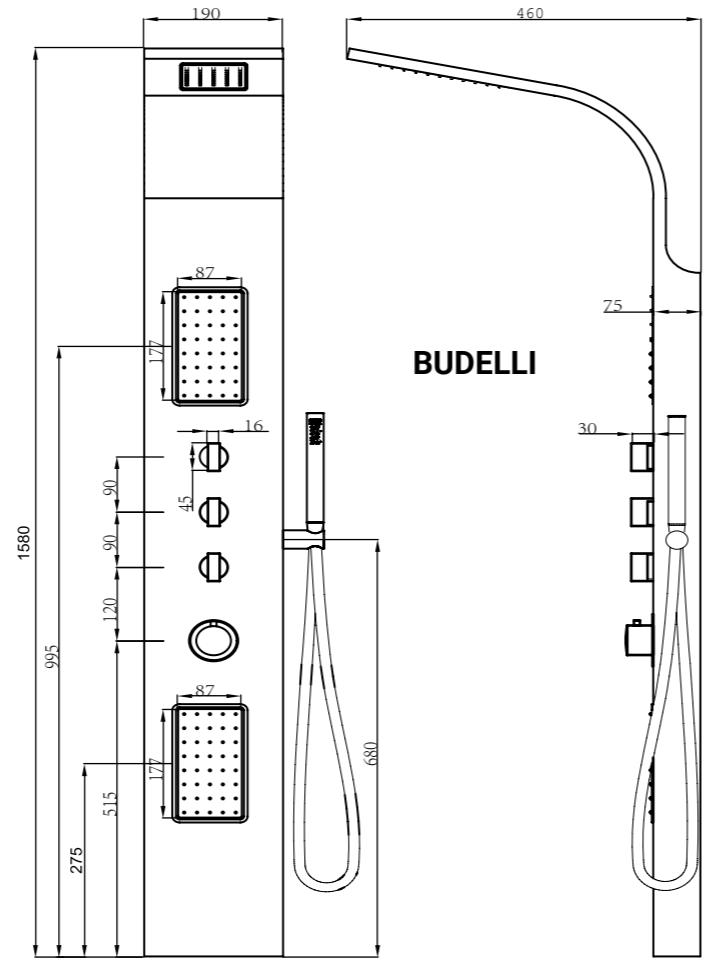
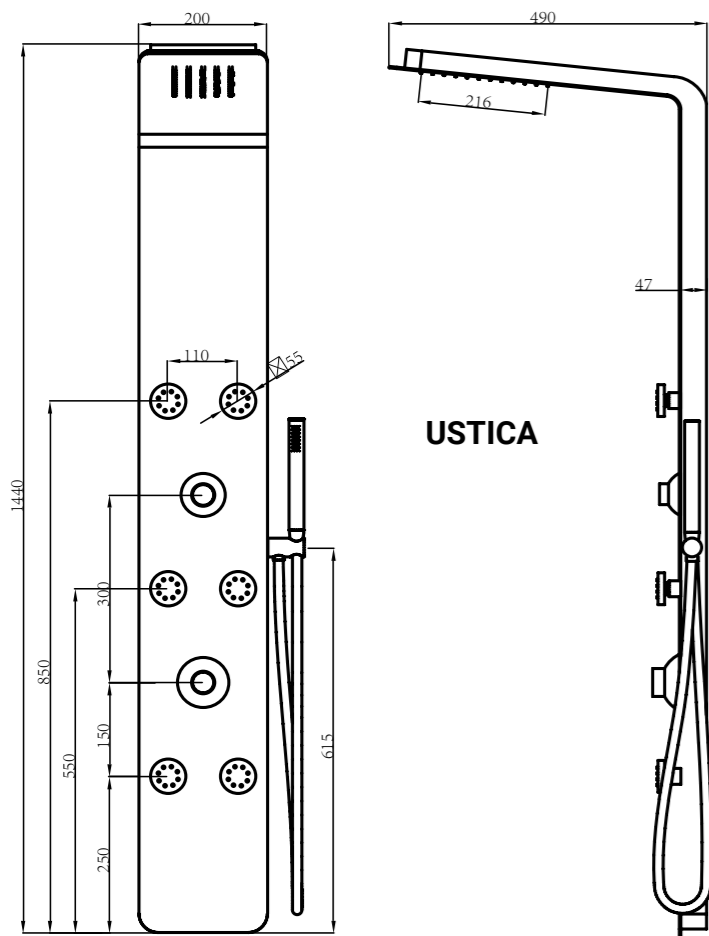

DISEGNI TECNICI COLONNE DOCCIA

TECHNICAL DRAWING SHOWER COLUMNS
 TECHNISCHE ZEICHNUNG DER DUSCHSÄULE
 DESSIN TECHNIQUE DES COLONNES DE DOUCHE

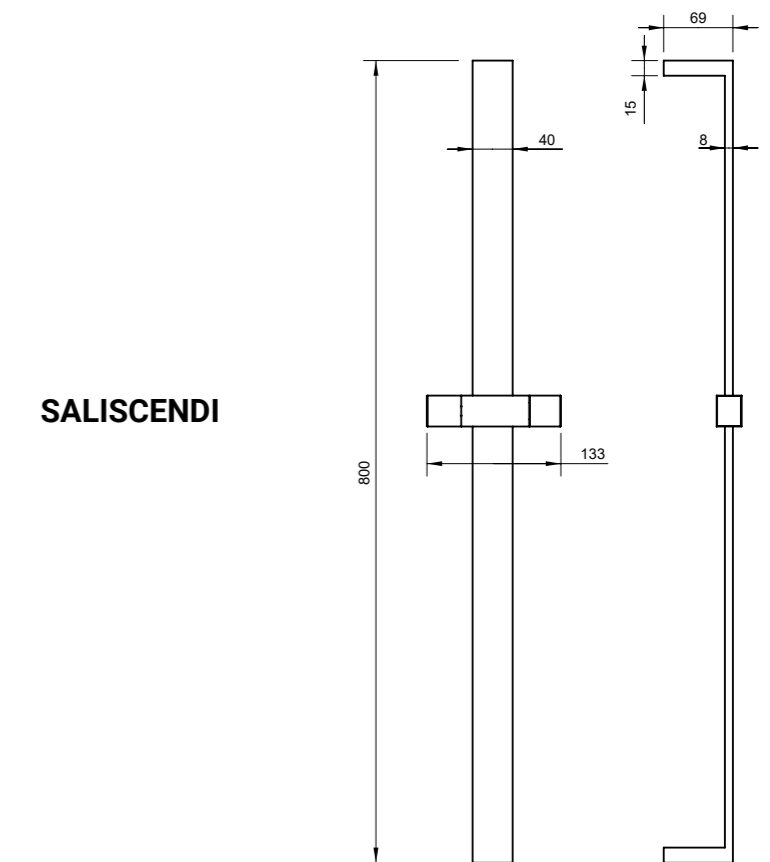
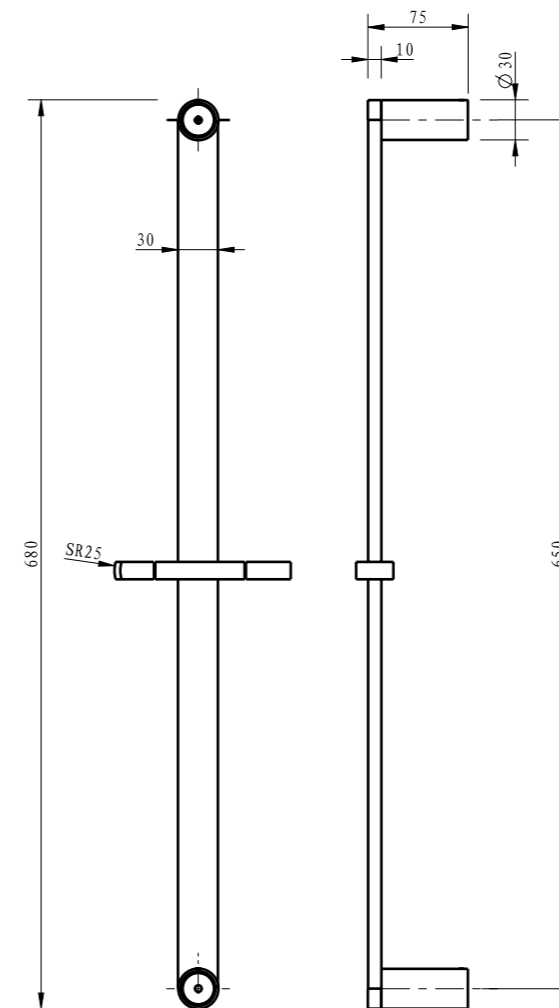
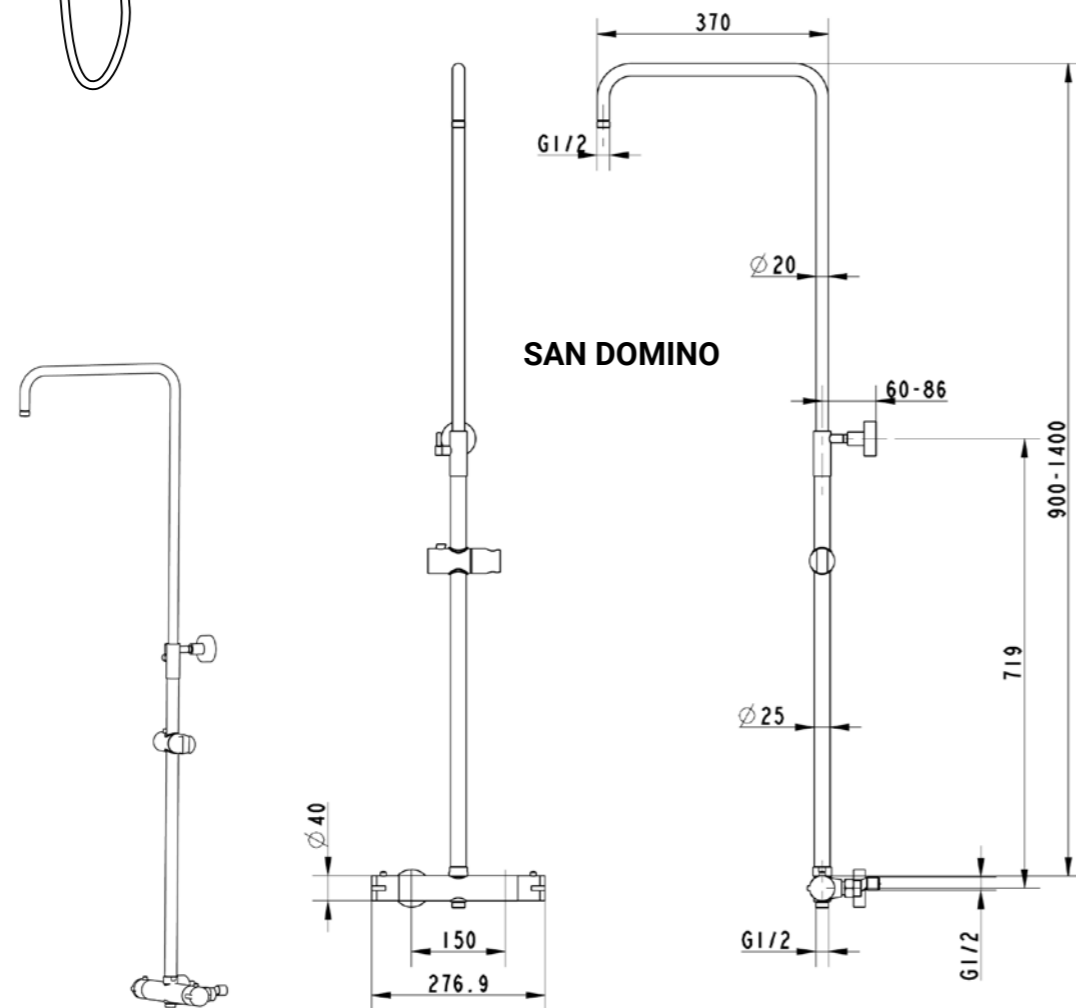
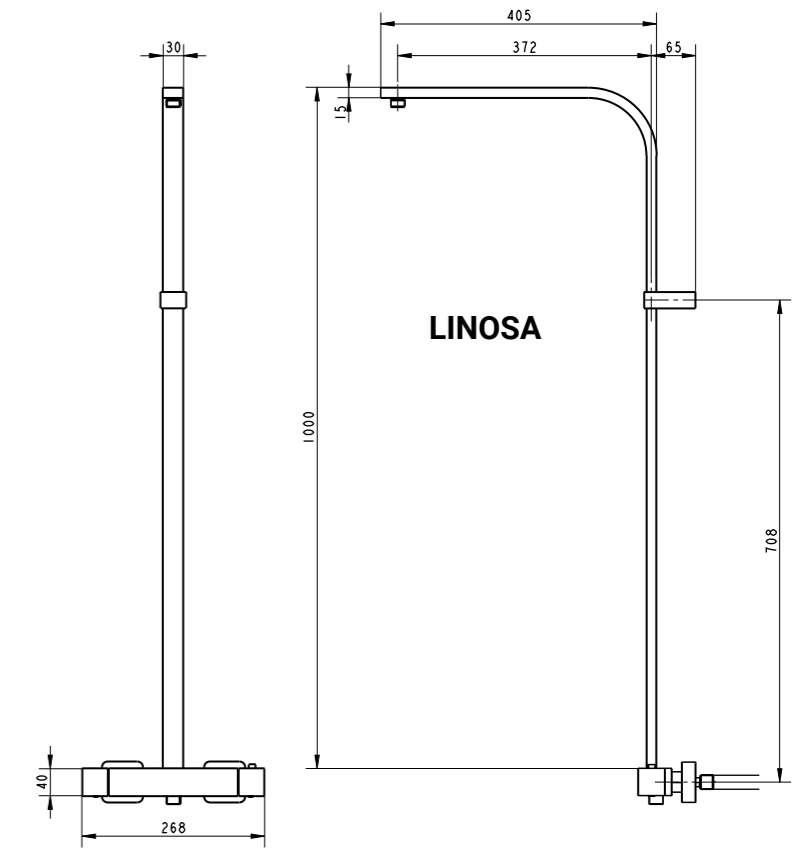
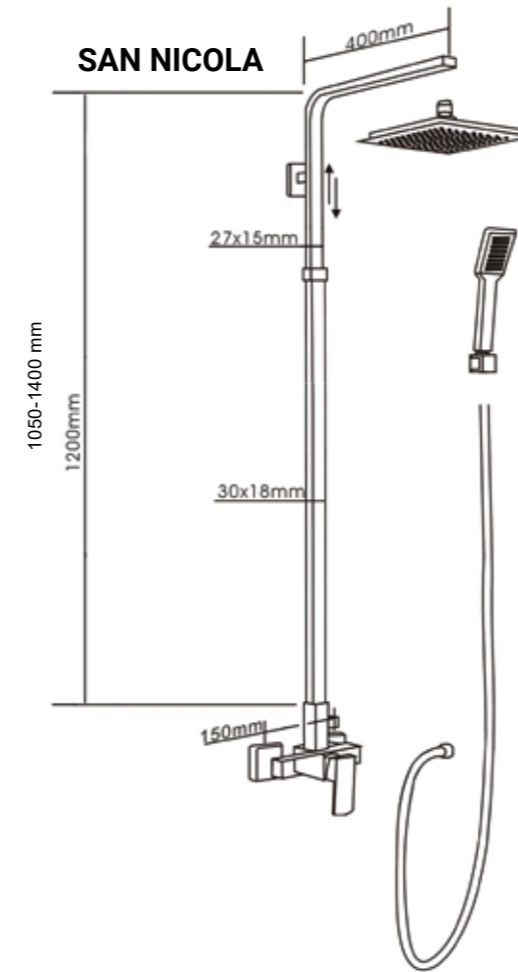
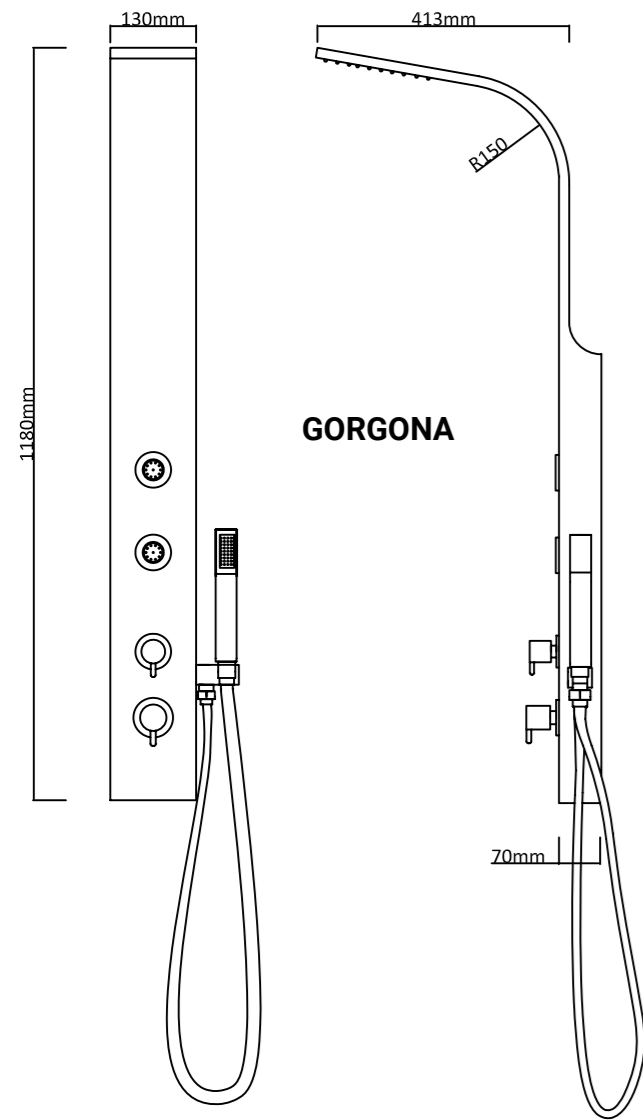

SOFFIONI DOCCIA

SHOWER HEADS
DUSCHKÖPFE
DOUCHE DE TETE

CARATTERISTICHE GENERALI

- Realizzati interamente in Acciaio Inox 304.
- Spessore 2 mm.

GENERAL CHARACTERISTICS

- Made entirely of stainless steel 304.
- 2 mm thickness.

TECHNISCHE EIGENSCHAFTEN

- Komplette aus Edelstahl 304.
- 2mm stark.

SPECIFICATIONS GENERALES

- Fabriquées entièrement en acier inoxydable 304.
- Épaisseur de 2 mm.



SOFFIONI INOX 2 MM. A PARETE



WALL SHOWER HEAD OF STAINLESS STEEL 2 MM
ROSTFREIE WANDDUSCHKÖPFE 2 MM
DOUCHE DE TÊTE À MUR EN ACIER INOXYDABLE DE 2 MM

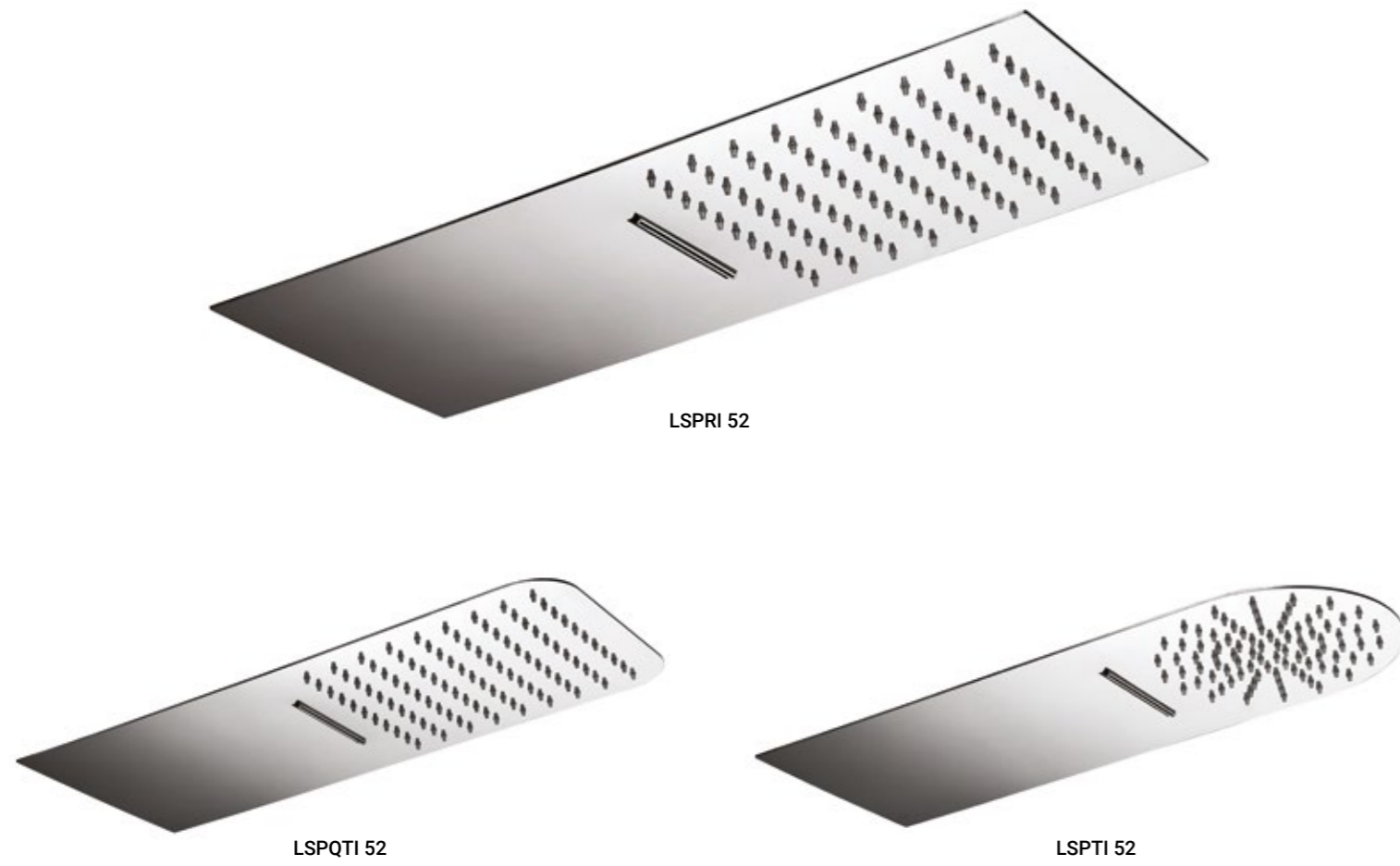

LSPRI 52

LSPQTI 52

LSPTI 52

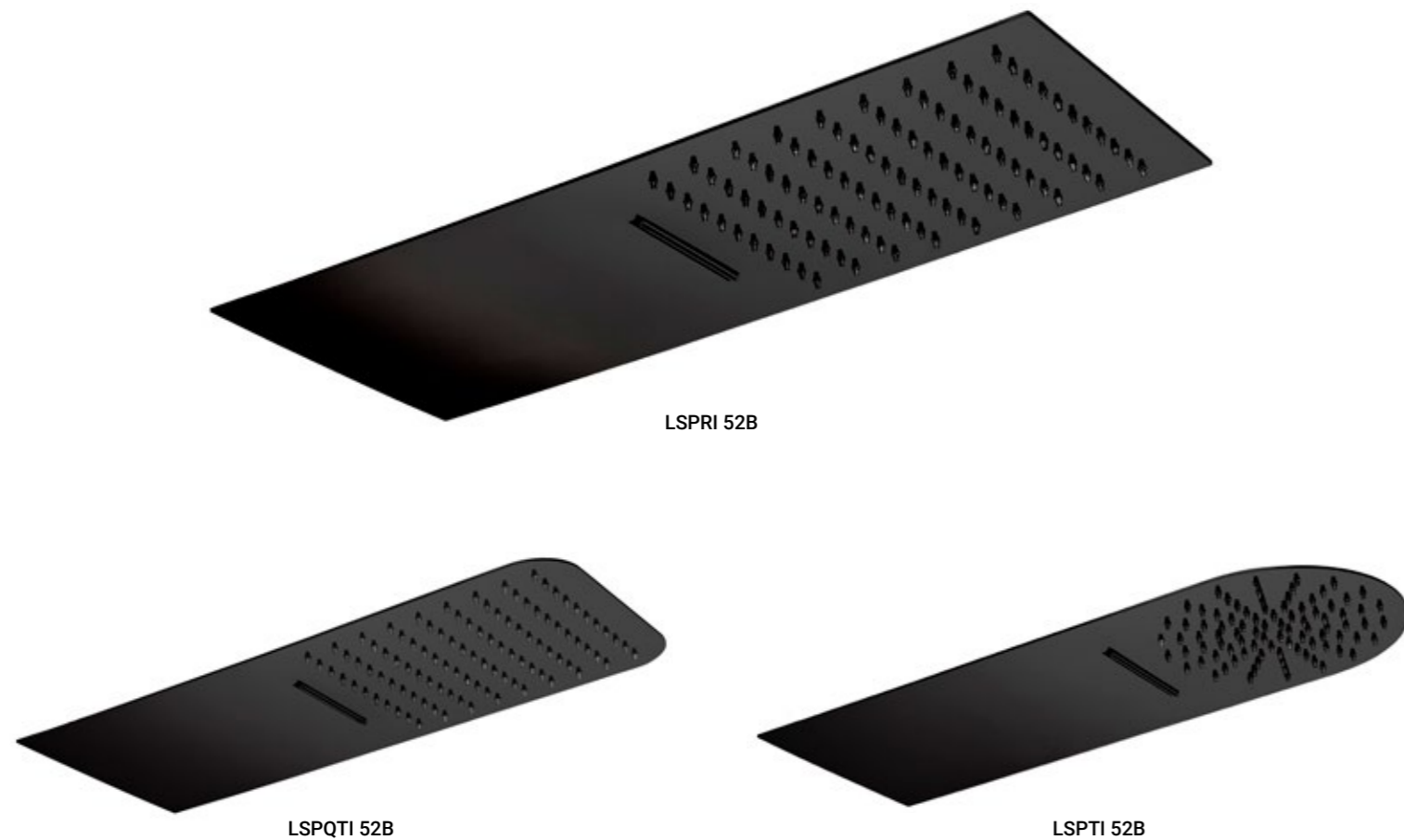

LSPRI 52B

LSPQTI 52B

LSPTI 52B

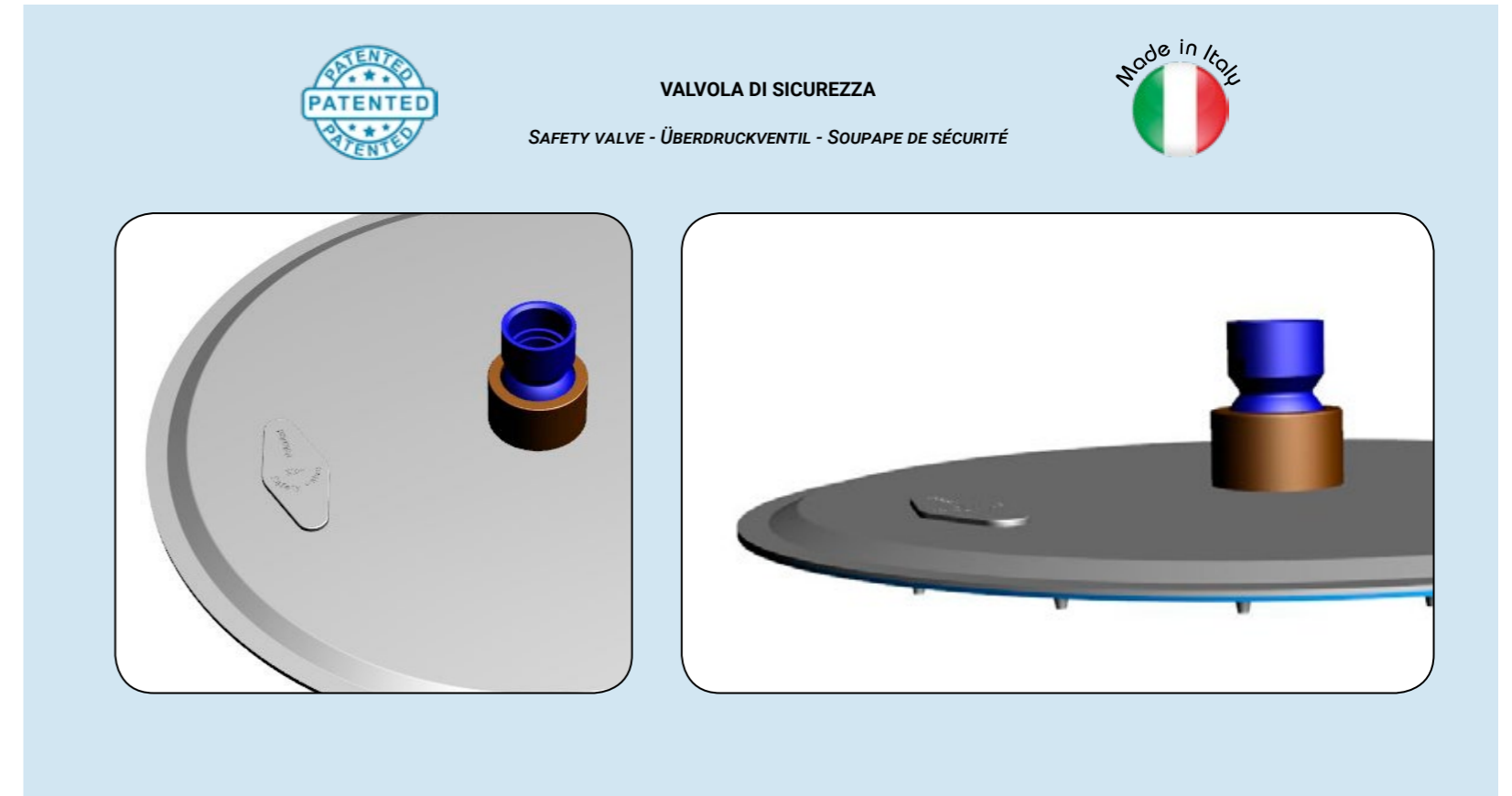

| CODICE | Formato (cm) | Prezzo (€) |
|---|--|-------------------------------------|
| <small>Code - Artikel - Article</small> | <small>Size - Format - Dimension</small> | <small>Price - Preis - Prix</small> |
| LSPRI 52 | 22 x 50 | 790,00 |
| LSPQTI 52 | 22 x 50 | 790,00 |
| LSPTI 52 | 22 x 50 | 908,00 |



| CODICE | Formato (cm) | Prezzo (€) |
|---|--|-------------------------------------|
| <small>Code - Artikel - Article</small> | <small>Size - Format - Dimension</small> | <small>Price - Preis - Prix</small> |
| LSPRI 52B | 22 x 50 | 1.293,00 |
| LSPQTI 52B | 22 x 50 | 1.295,00 |
| LSPTI 52B | 22 x 50 | 1.489,00 |



SOFFIONI INOX 2 MM. LSQI-LSRI



STEINLESS STEEL SHOWER HEADS 2 MM LSQI-LSRI
ROSTFREIE DUSCHKÖPFE 2 MM LSQI-LSRI
DOUCHE DE TÊTE EN ACIER INOXYDABLE DE 2MM LSQI-LSRI



LSQI 202



LSQI 202B



LSQI 252



LSQI 252B



LSQI 302



LSQI 302B



LSQI 402



LSQI 402B



LSRI 2535



LSRI 2535B



VALVOLA DI SICUREZZA
SAFETY VALVE - ÜBERDRUCKVENTIL - SOUPAPE DE SÉCURITÉ







| CODICE | Formato (cm) | Prezzo (€) |
|---|--|-------------------------------------|
| <small>Code - Artikel - Article</small> | <small>Size - Format - Dimension</small> | <small>Price - Preis - Prix</small> |
| LSQI 202 | 20 x 20 | 101,00 |
| LSQI 252 | 25 x 25 | 137,00 |
| LSQI 302 | 30 x 30 | 189,00 |
| LSQI 402 | 40 x 40 | 263,00 |
| LSRI2535 | 25 x 35 | 190,00 |



| CODICE | Formato (cm) | Prezzo (€) |
|---|--|-------------------------------------|
| <small>Code - Artikel - Article</small> | <small>Size - Format - Dimension</small> | <small>Price - Preis - Prix</small> |
| LSQI 202B | 20 x 20 | 233,00 |
| LSQI 252B | 25 x 25 | 268,00 |
| LSQI 302B | 30 x 30 | 329,00 |
| LSQI 402B | 40 x 40 | 626,00 |
| LSRI2535B | 25 x 35 | 505,00 |



SOFFIONI INOX 2 MM. LSTI



STEINLESS STEEL SHOWER HEADS 2 MM LSTI
ROSTFREIE DUSCHKÖPFE 2 MM LSTI
DOUCHE DE TÊTE EN ACIER INOXYDABLE DE 2MM LSTI

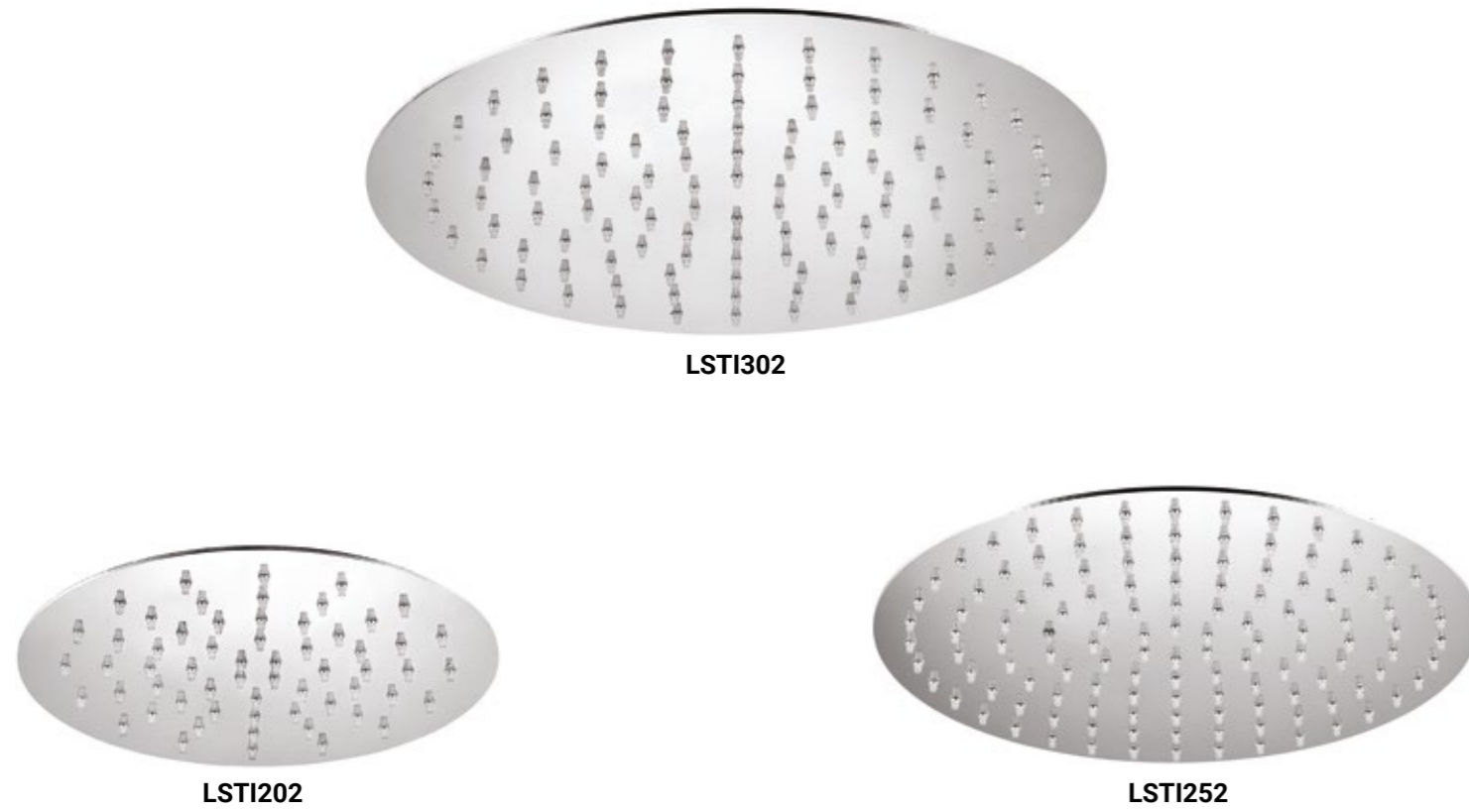

LSTI302

LSTI202

LSTI252

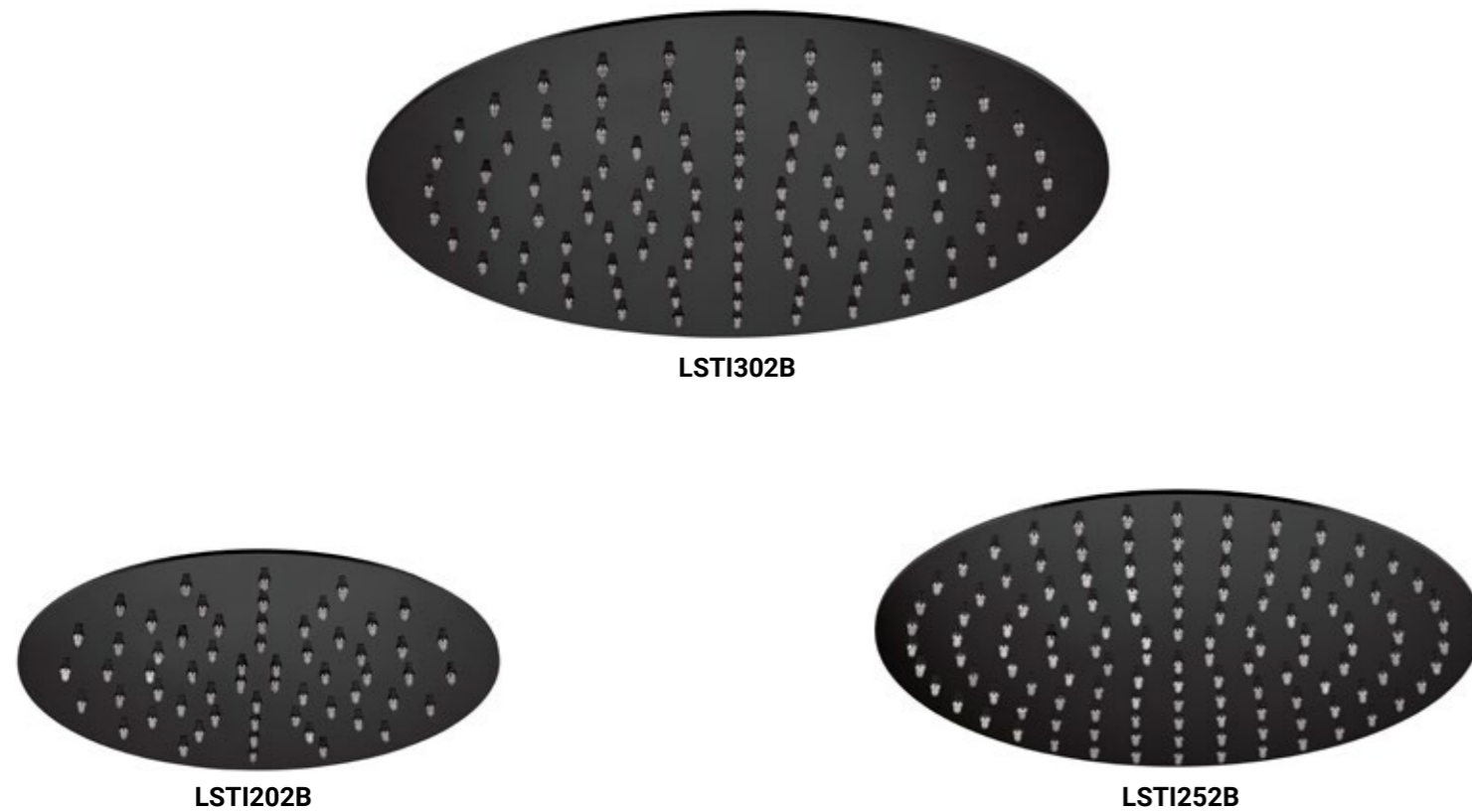

LSTI302B

LSTI202B

LSTI252B

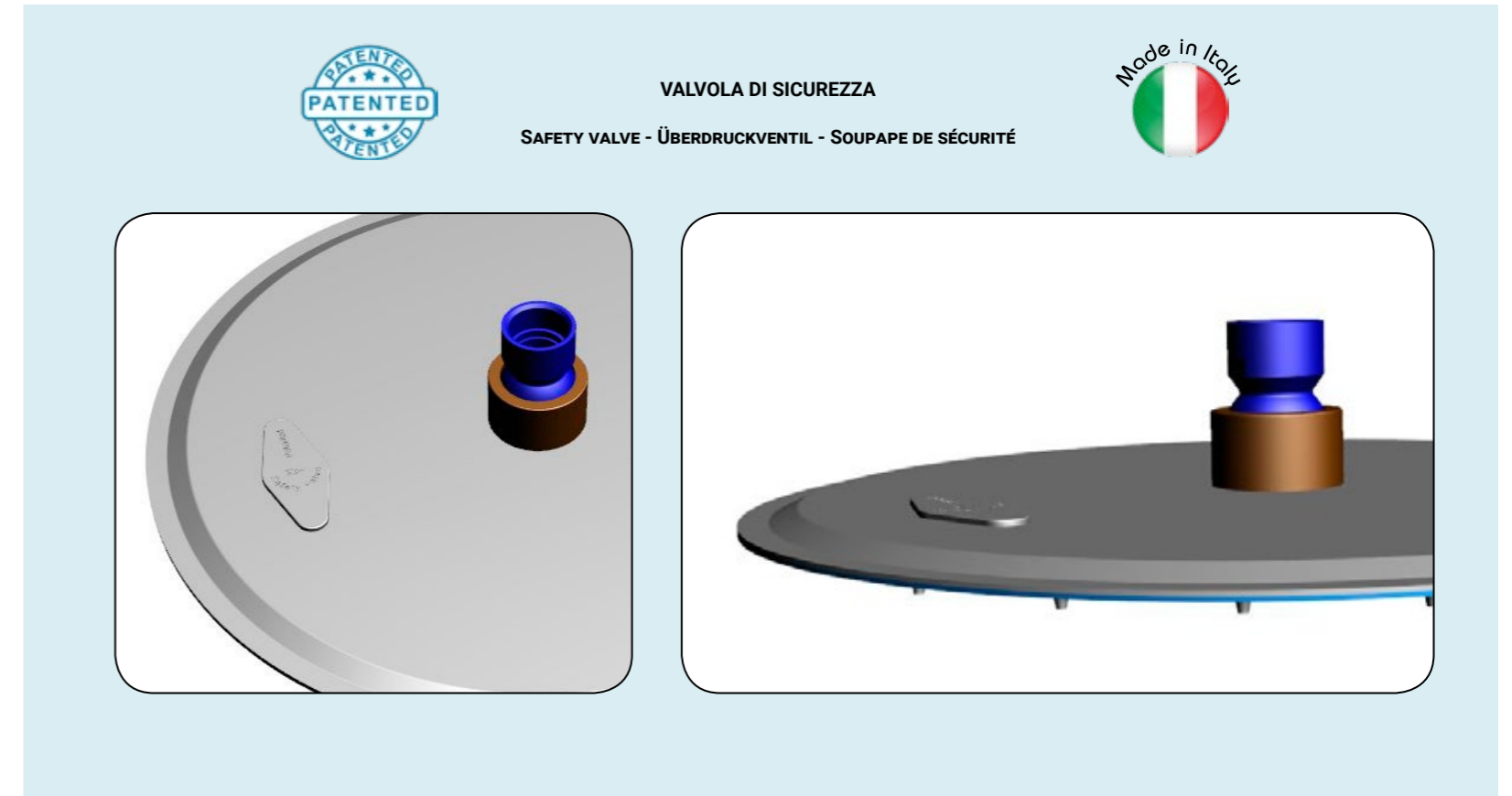

| CODICE | Formato (cm) | Prezzo (€) |
|---|--|-------------------------------------|
| <small>Code - Artikel - Article</small> | <small>Size - Format - Dimension</small> | <small>Price - Preis - Prix</small> |
| LSTI 202 | Ø 20 | 100,00 |
| LSTI 252 | Ø 25 | 129,00 |
| LSTI 302 | Ø 30 | 179,00 |



| CODICE | Formato (cm) | Prezzo (€) |
|---|--|-------------------------------------|
| <small>Code - Artikel - Article</small> | <small>Size - Format - Dimension</small> | <small>Price - Preis - Prix</small> |
| LSTI 202B | Ø 20 | 226,00 |
| LSTI 252B | Ø 25 | 275,00 |
| LSTI 302B | Ø 30 | 317,00 |



WIFI INOX 2MM

SOFFIONE QUADRATO
 SQUARE SHOWER HEAD
 VIERECKIGER DUSCHKOPF
 DOUCHE DE TÊTE CARRÉE

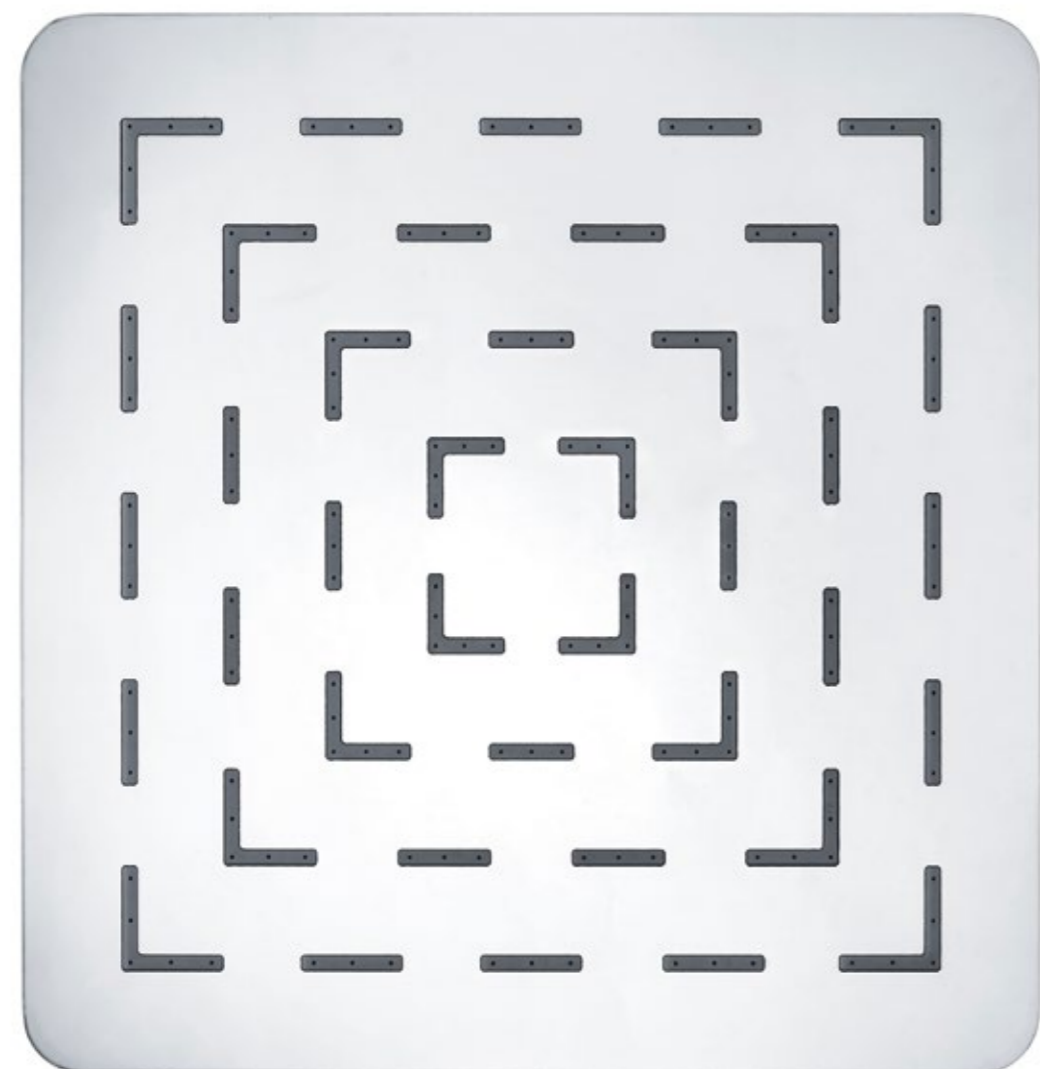

| CODICE <i>Code - Artikel - Article</i> | Formato (cm) <i>Size - Format - Dimension</i> | Spessore (cm) <i>Thickness - Stärke - Épaisseur</i> | Prezzo (€) <i>Price - Preis - Prix</i> |
|--|---|---|--|
| LSSQW 202 | 20 x 20 | 0,2 | 76,00 |
| LSSQW 252 | 25 x 25 | 0,2 | 115,00 |
| LSSQW 302 | 30 x 30 | 0,2 | 154,00 |

PROMO PACK (kit) 202QW : 250,00 € **PROMO PACK (kit) 252QW : 290,00 €**

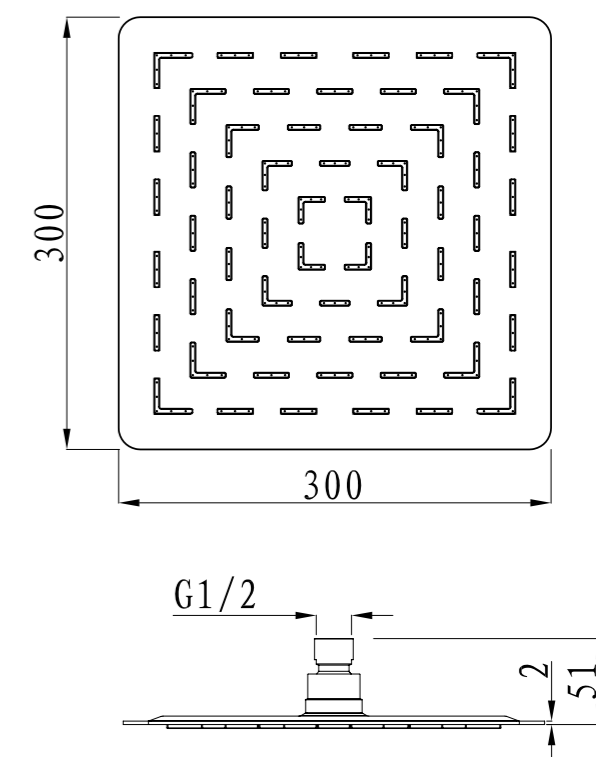
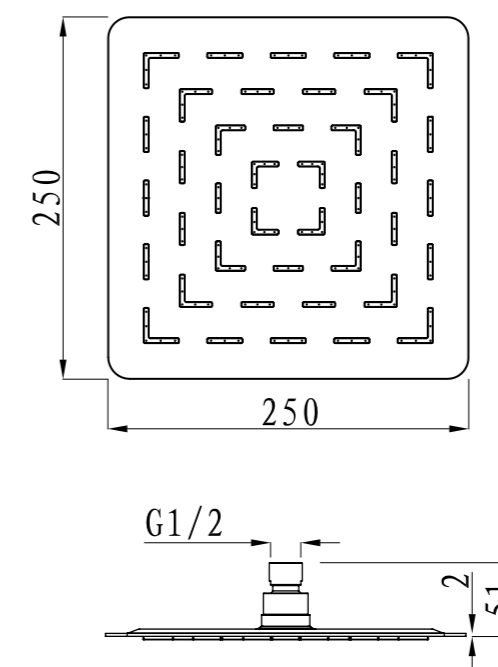
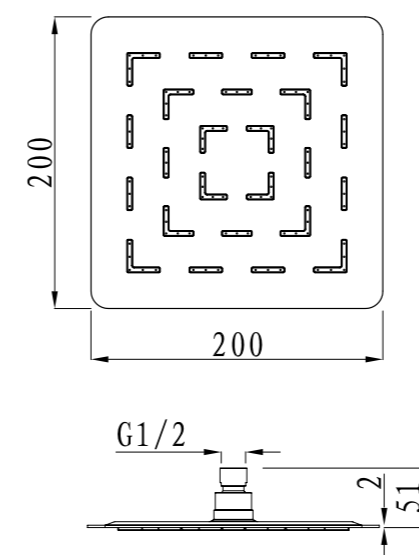

WIFI INOX 2MM

SOFFIONE TONDO
 ROUND SHOWER HEAD
 RUNDER DUSCHKOPF
 DOUCHE DE TÊTE RONDE



| CODICE <i>Code - Artikel - Article</i> | Formato (cm) <i>Size - Format - Dimension</i> | Spessore (cm) <i>Thickness - Stärke - Épaisseur</i> | Prezzo (€) <i>Price - Preis - Prix</i> |
|--|---|---|--|
| LSSTW 202 | Ø 20 | 0,2 | 73,00 |
| LSSTW 252 | Ø 25 | 0,2 | 104,00 |
| LSSTW 302 | Ø 30 | 0,2 | 145,00 |

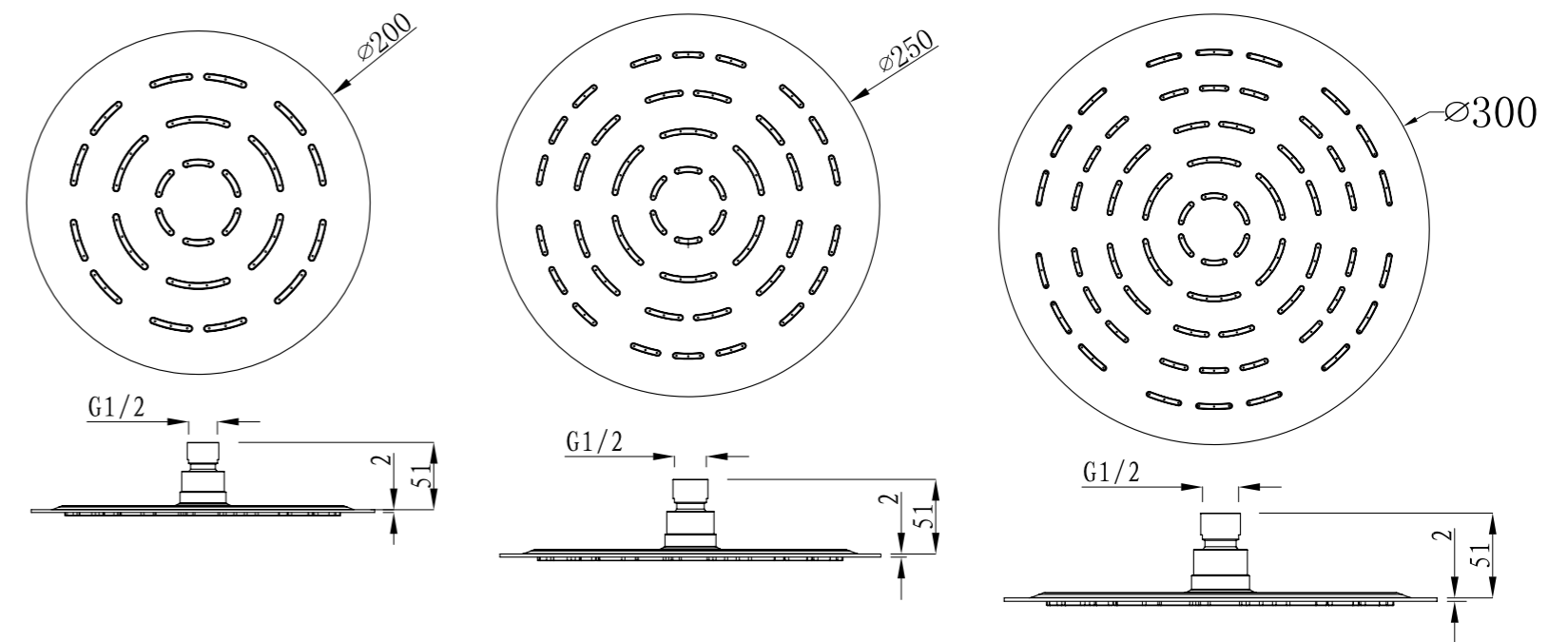
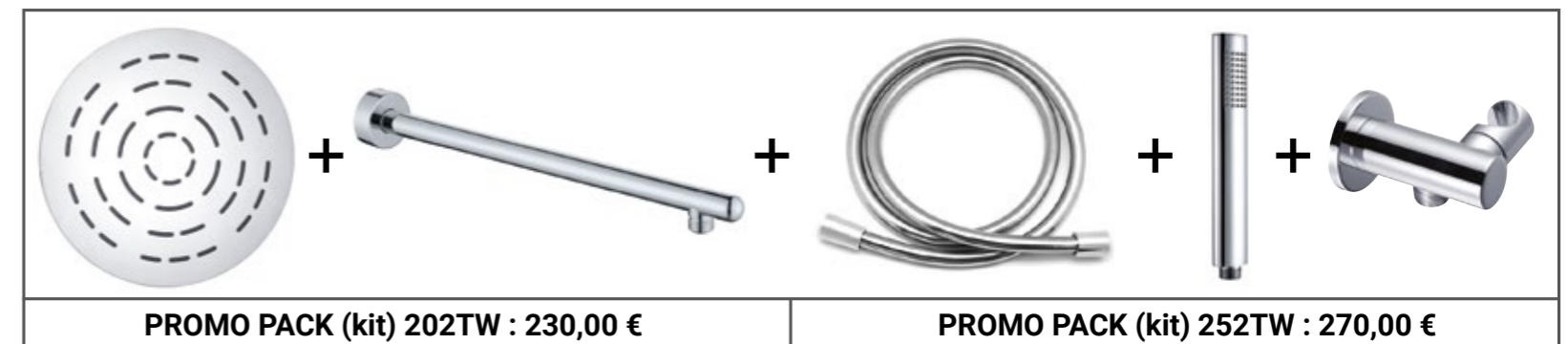

SOFFIONE INOX SPAZZOLATO 2MM

SOFFIONE QUADRATO
 SQUARE SHOWER HEAD OF BRUSHED STEINLESS STEEL 2MM
 VIERECKIGER DUSCHKOPF AUS GEBÜRSTETER ROSTFREIER STAHL 2MM
 DOUCHE DE TETE CARRÉE EN ACIER BROSSÉ INOXYDABLE DE 2MM

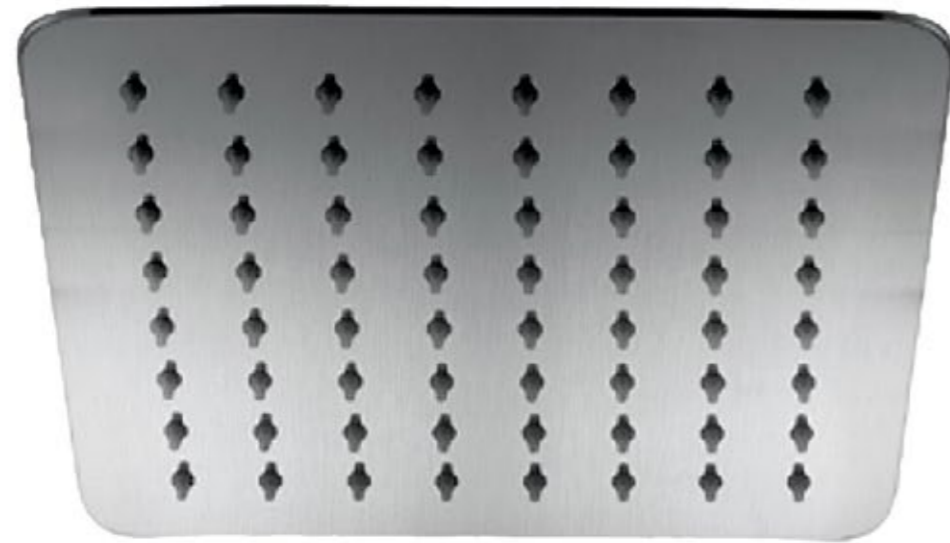

| CODICE <i>Code - Artikel - Article</i> | Formato (cm) <i>Size - Format - Dimension</i> | Spessore (cm) <i>Thickness - Stärke - Épaisseur</i> | Prezzo (€) <i>Price - Preis - Prix</i> |
|--|---|---|--|
| LSSQ 202XB | 20 x 20 | 0,2 | 78,00 |
| LSSQ 252XB | 25 x 25 | 0,2 | 125,00 |
| LSSQ 302XB | 30 x 30 | 0,2 | 164,00 |

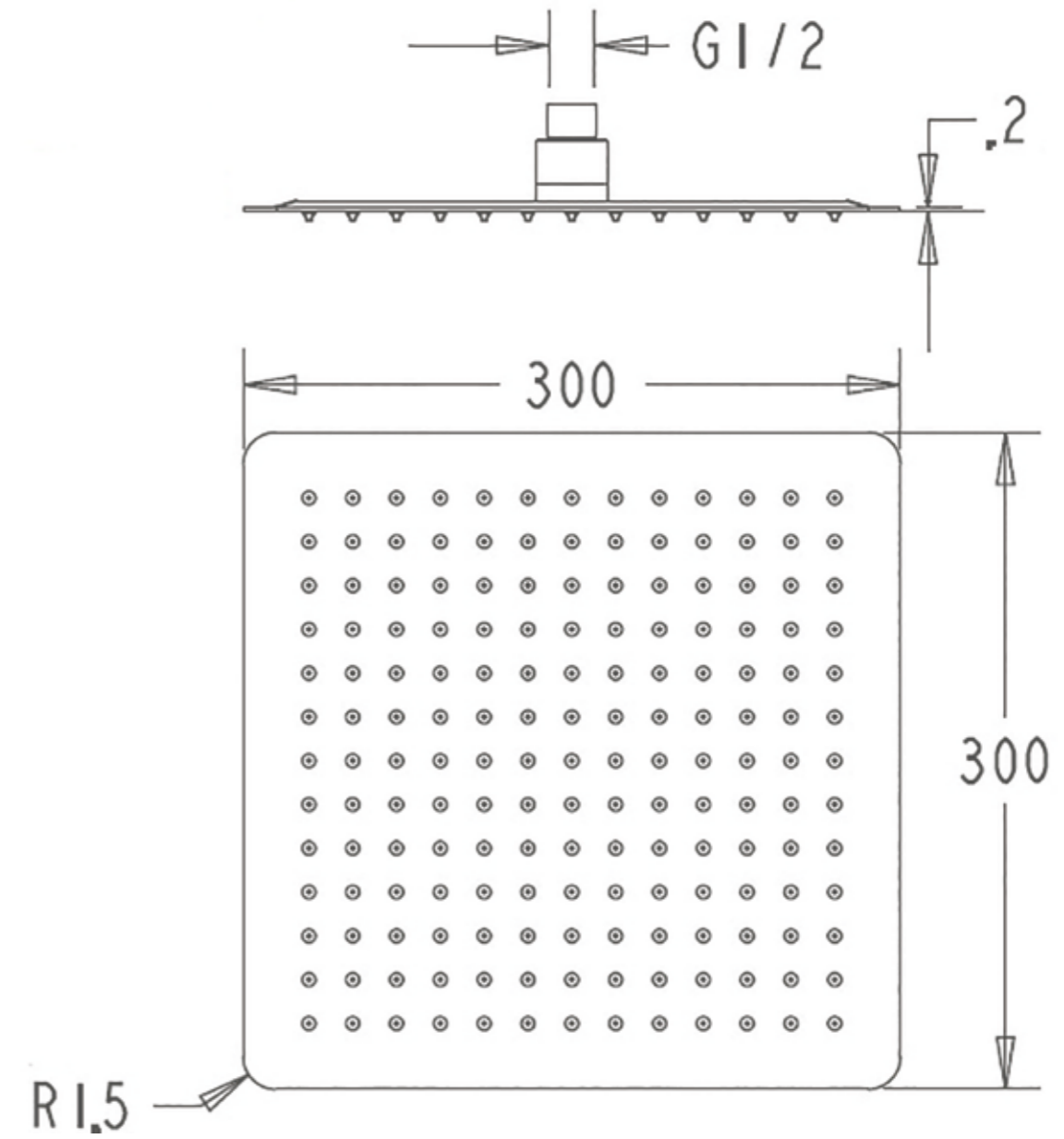

SOFFIONI LSSQ INOX 2MM.

SOFFIONE QUADRATO
SQUARE SHOWER HEAD
VIERECKIGER DUSCHKOPF
DOUCHE DE TÊTE CARRÉE



| CODICE <small>Code - Artikel - Article</small> | Formato (cm) <small>Size - Format - Dimension</small> | Spessore (cm) <small>Thickness - Stärke - Épaisseur</small> | Prezzo (€) <small>Price - Preis - Prix</small> |
|---|--|--|---|
| LSSQ 202 | 20 x 20 | 0,2 | 78,00 |
| LSSQ 252 | 25 x 25 | 0,2 | 125,00 |
| LSSQ 302 | 30 x 30 | 0,2 | 164,00 |

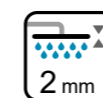
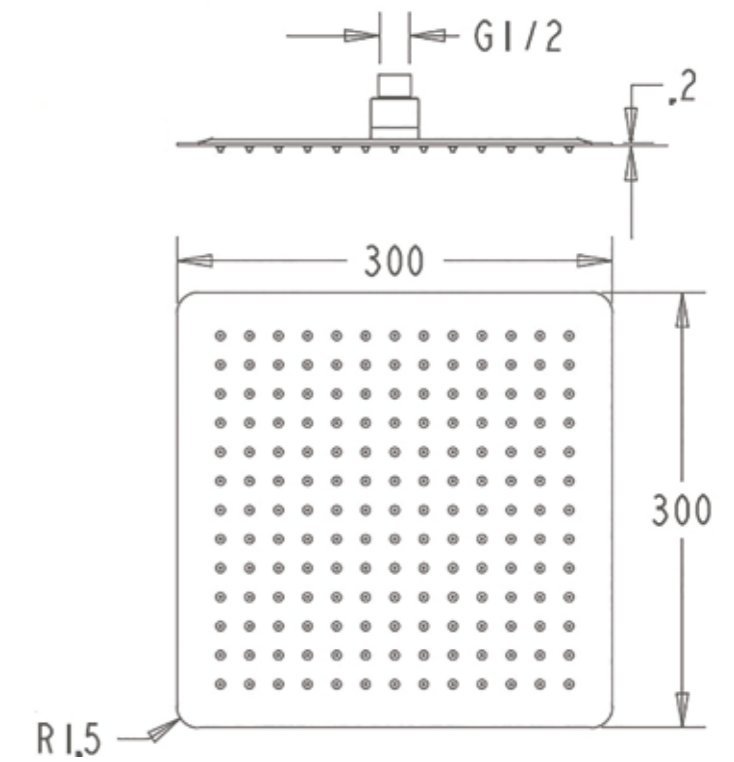
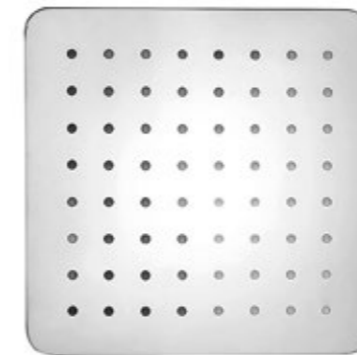
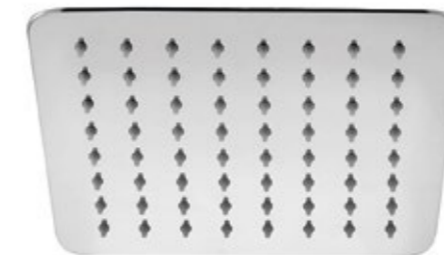
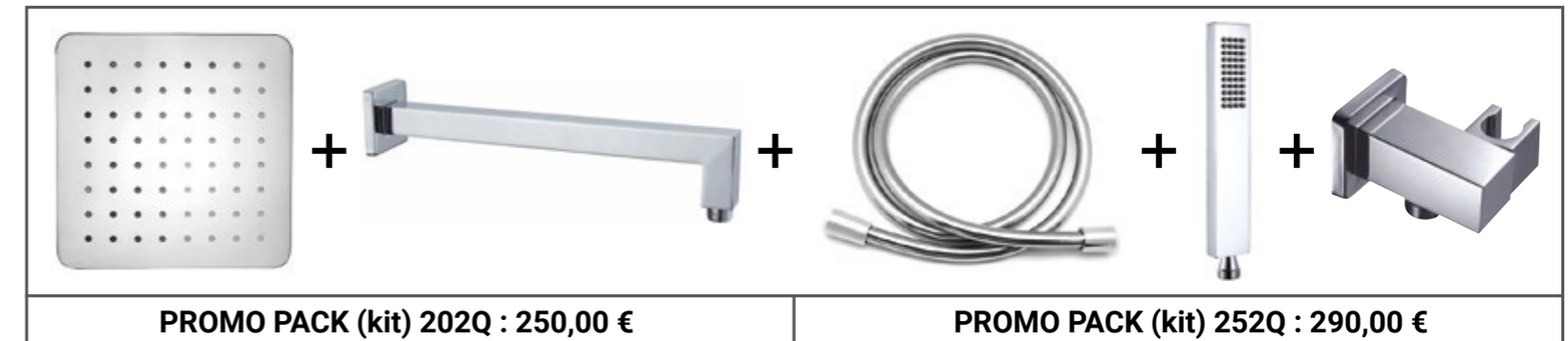

SOFFIONI INOX LSSR 2MM.

SOFFIONE RETTANGOLARE
RECTANGULAR SHOWER HEAD
RECHTECKIGER DUSCHKOPF
DOUCHE DE TÊTE RECTANGULAIRE



| CODICE <small>Code - Artikel - Article</small> | Formato (cm) <small>Size - Format - Dimension</small> | Spessore (cm) <small>Thickness - Stärke - Épaisseur</small> | Prezzo (€) <small>Price - Preis - Prix</small> |
|---|--|--|---|
| LSSR 2542 | 25 x 40 | 0,2 | 267,00 |

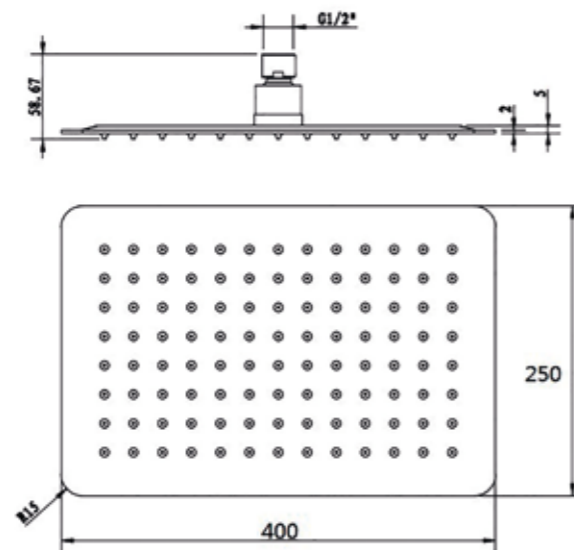

SOFFIONI LSST INOX 2MM.

SOFFIONE TONDO
ROUND SHOWER HEAD
RUNDER DUSCHKOPF
DOUCHE DE TÊTE RONDE



| CODICE <small>Code - Artikel - Article</small> | Formato (cm) <small>Size - Format - Dimension</small> | Spessore (cm) <small>Thickness - Stärke - Épaisseur</small> | Prezzo (€) <small>Price - Preis - Prix</small> |
|---|--|--|---|
| LSST 202 | Ø 20 | 0,2 | 74,00 |
| LSST 252 | Ø 25 | 0,2 | 112,00 |
| LSST 302 | Ø 30 | 0,2 | 154,00 |

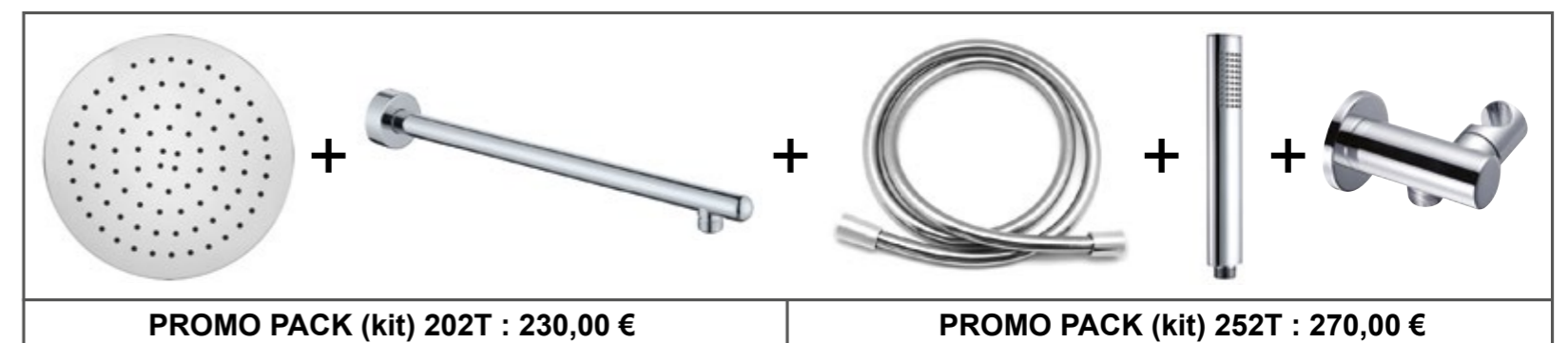

SOFFIONI LSSRT INOX 2MM.

SOFFIONE RETTANGOLARE CON ANGOLO TONDO
 RECTANGULAR SHOWER WITH ROUND CORNER
 GERUNDETER RECHTECKIGER DUSCHKOPF
 DOUCHE DE TÊTE RECTANGULAIRE AVEC ANGLE ARRONDI



| CODICE Code - Artikel - Article | Formato (cm) Size - Format - Dimension | Spessore (cm) Thickness - Stärke - Épaisseur | Prezzo (€) Price - Preis - Prix |
|------------------------------------|---|---|------------------------------------|
| LSSRT 2032 | 20 x 30 | 0,2 | 135,00 |

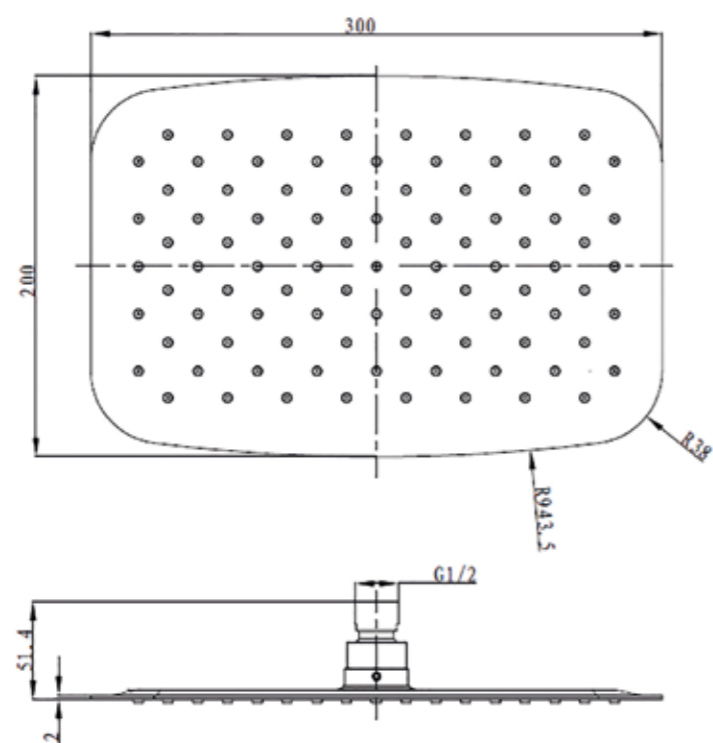

SOFFIONI LSSO INOX 2MM.

SOFFIONE OVALE
 OVAL SHOWER HEAD
 OVALER DUSCHKOPF
 DOUCHE DE TÊTE OVALE



| CODICE Code - Artikel - Article | Formato (cm) Size - Format - Dimension | Spessore (cm) Thickness - Stärke - Épaisseur | Prezzo (€) Price - Preis - Prix |
|------------------------------------|---|---|------------------------------------|
| LSSO 2032 | 20 x 30 | 0,2 | 130,00 |

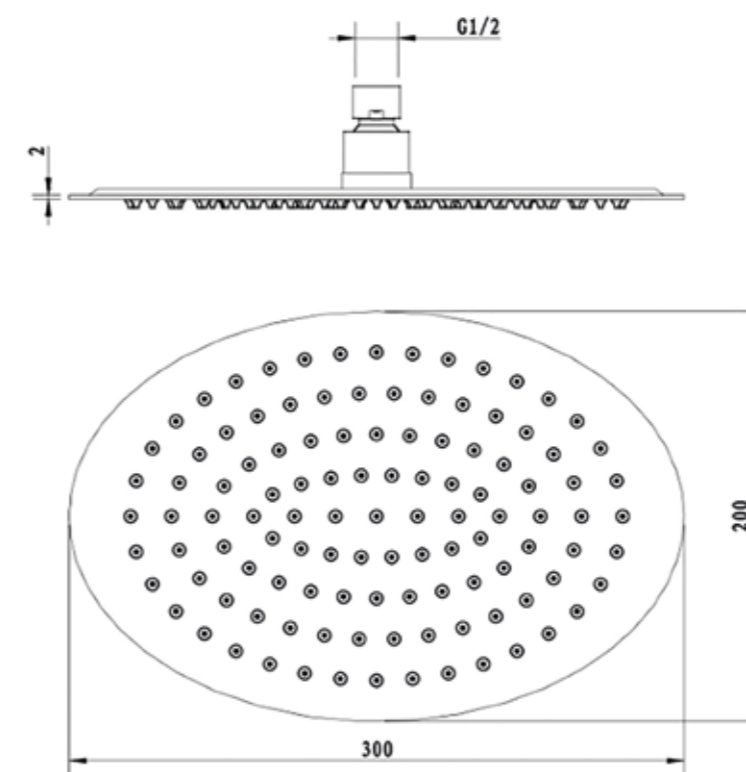



LSBQ 30 - LSBQ 40



LSBQ 40XB



LSBQ 30B - LSBQ 40B



LSBQN 40



LSBT 30 - LSBT 40



LSBT 30B - LSBT 40B



LSBTN 40



LSBO 40

| CODICE Code - Artikel - Article | Formato (cm) Size - Format - Dimension | Spessore (cm) Thickness - Stärke - Épaisseur | Prezzo (€) Price - Preis - Prix |
|------------------------------------|---|--|------------------------------------|
| LSBQ 30 | 2,5 x 30 | Braccio Quadrato Square shower arm - Viereckiger Duschkopfarm - Bras carré | 76,00 |
| LSBQ 40 | 2,5 x 40 | Braccio Quadrato Square shower arm - Viereckiger Duschkopfarm - Bras carré | 83,00 |
| LSBQ 40XB | 2,5 x 40 | Braccio Quadrato Square shower arm - Viereckiger Duschkopfarm - Bras carré | 110,00 |
| LSBQ 30B | 2,5 x 30 | Braccio Quadrato Square shower arm - Viereckiger Duschkopfarm - Bras carré | 109,00 |
| LSBQ 40B | 2,5 x 40 | Braccio Quadrato Square shower arm - Viereckiger Duschkopfarm - Bras carré | 117,00 |
| LSBT 30 | 2,5 x 30 | Braccio Tondo Round shower arm - Runder Duschkopfarm - Bras rond | 54,00 |
| LSBT 40 | 2,5 x 40 | Braccio Tondo Round shower arm - Runder Duschkopfarm - Bras rond | 59,00 |
| LSBT 30B | 2,5 x 30 | Braccio Tondo Round shower arm - Runder Duschkopfarm - Bras rond | 88,00 |
| LSBT 40B | 2,5 x 40 | Braccio Tondo Round shower arm - Runder Duschkopfarm - Bras rond | 106,00 |
| LSBTN 40 | 2,5 x 40 | Braccio Tondo New - New round shower arm Runder Duschkopfarm "New" - Bras rond New | 53,00 |
| LSBQN 40 | 3,5 x 40 | Braccio Quadrato New - New square shower arm Viereckiger Duschkopfarm „New“ - Bras carré New | 77,00 |
| LSBO 40 | 4,4 x 40 | Braccio Ovale Oval shower arm - Ovaler Duschkopfarm - Bras ovale | 99,00 |

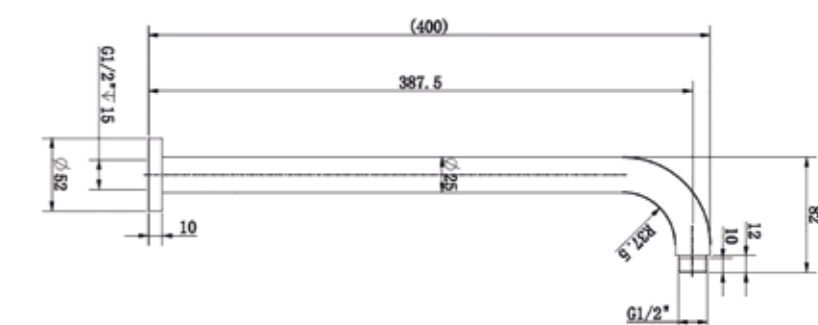
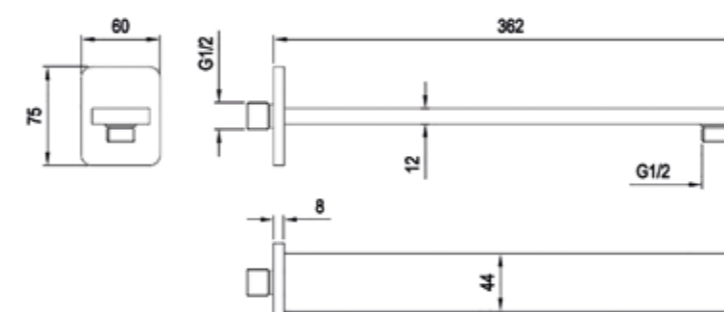
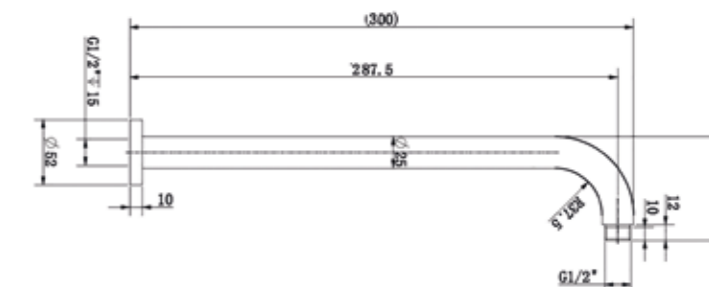

LSDQ 01



LSDQ 01XB



LSDQ 01B



LSDT 01



LSDT 01B

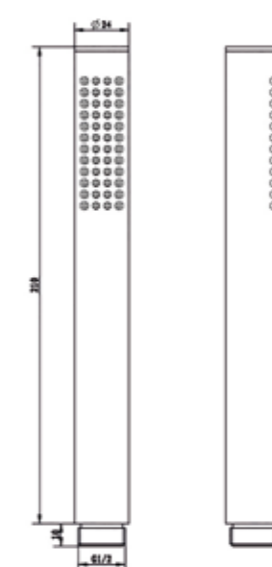
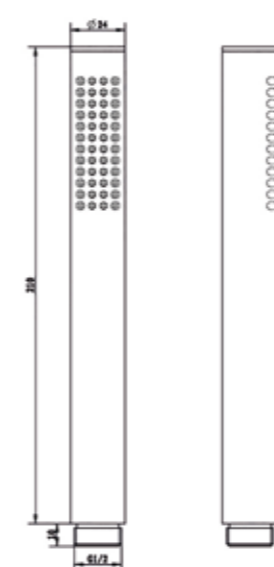
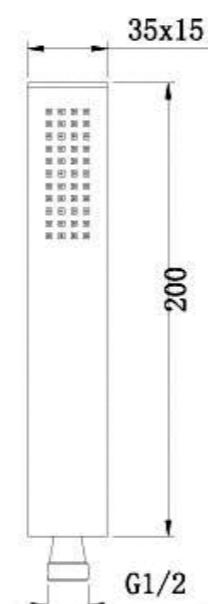
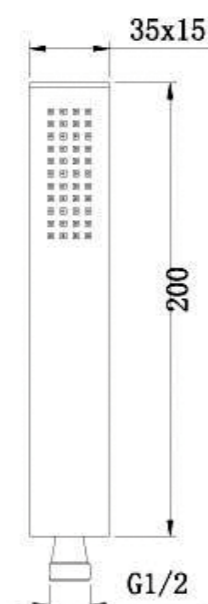
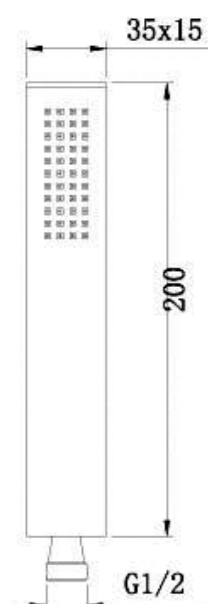

| CODICE Code - Artikel - Article | Descrizione Description - Beschreibung - Description | Prezzo (€) Price - Preis - Prix |
|------------------------------------|--|------------------------------------|
| LSDQ 01 | Doccetta Quadrata Square hand shower - Viereckige Handbrause - Douchette à main carrée | 40,00 |
| LSDQ 01XB | Doccetta Quadrata Square hand shower - Viereckige Handbrause - Douchette à main carrée | 65,00 |
| LSDQ 01B | Doccetta Quadrata Square hand shower - Viereckige Handbrause - Douchette à main carrée | 49,00 |

| CODICE Code - Artikel - Article | Descrizione Description - Beschreibung - Description | Prezzo (€) Price - Preis - Prix |
|------------------------------------|--|------------------------------------|
| LSDT 01 | Doccetta Tonda Round hand shower - Runde Handbrause - Douche à main ronde | 37,00 |
| LSDT 01B | Doccetta Tonda Round hand shower - Runde Handbrause - Douchette à main ronde | 48,00 |

RACCORDI MURO

WALL FITTING
WANDANSCHLUSSTÜCK
SUPPORT



LSRMQ 01



LSRMQ 01XB

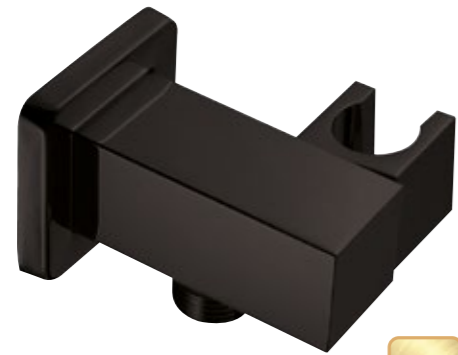

LSRMQ 01B

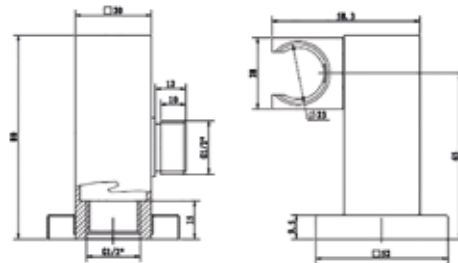

LSRMT 01



LSRMT 01B

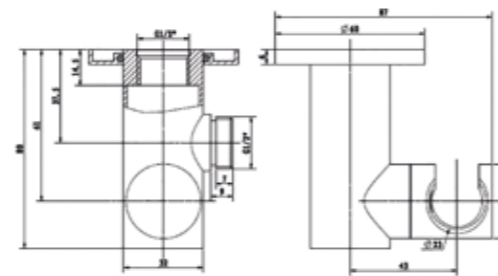

| CODICE Code - Artikel - Article | Descrizione Description - Beschreibung - Description | Prezzo (€) Price - Preis - Prix |
|------------------------------------|--|------------------------------------|
| LSRMQ 01 | Raccordo Quadrato - Square wall fitting - Viereckiger Wandanschlussstück - Support carré | 61,00 |
| LSRMQ 01XB | Raccordo Quadrato - Square wall fitting - Viereckiger Wandanschlussstück - Support carré | 99,00 |
| LSRMQ 01B | Raccordo Quadrato - Square wall fitting - Viereckiger Wandanschlussstück - Support carré | 79,00 |
| LSRMT 01 | Raccordo Tondo - Round wall fitting - Runder Wandanschlussstück - Support rond | 54,00 |
| LSRMT 01B | Raccordo Tondo - Round wall fitting - Runder Wandanschlussstück - Support rond | 74,00 |

FLESSIBILI

FLEXIBLE
SCHLAUCH
FLEXIBLE

LSF 150 (PVC)

LSF 200 (PVC)



LSF 150XB

LSF 150B (PVC)

LSF 200B (PVC)



| CODICE Code - Artikel - Article | Descrizione Description - Beschreibung - Description | Prezzo (€) Price - Preis - Prix |
|------------------------------------|---|------------------------------------|
| LSF 150 | Flessibile - Flexible - Schlauch - Flexible (cm 150) | 30,00 |
| LSF 200 | Flessibile - Flexible - Schlauch - Flexible (cm 200) | 41,00 |
| LSF 150XB | Flessibile - Flexible - Schlauch - Flexible (cm 150) | 33,00 |
| LSF 150B | Flessibile - Flexible - Schlauch - Flexible (cm 150) | 33,00 |
| LSF 200B | Flessibile - Flexible - Schlauch - Flexible (cm 200) | 45,00 |



MISCELATORI



LSMQ 01



LSMQ 01XB



LSMQ 01B



LSMT 01



LSMT 01B

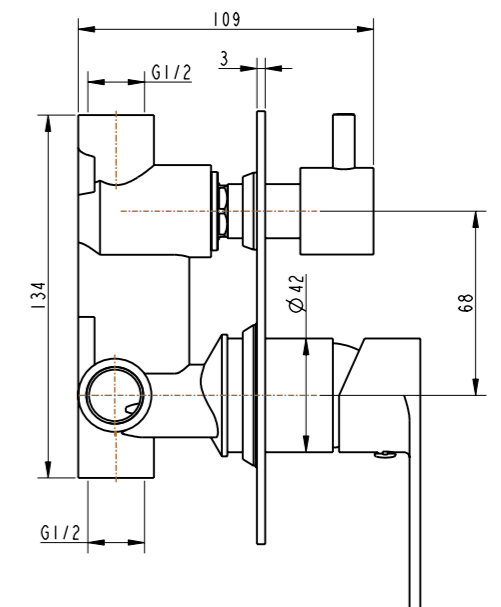
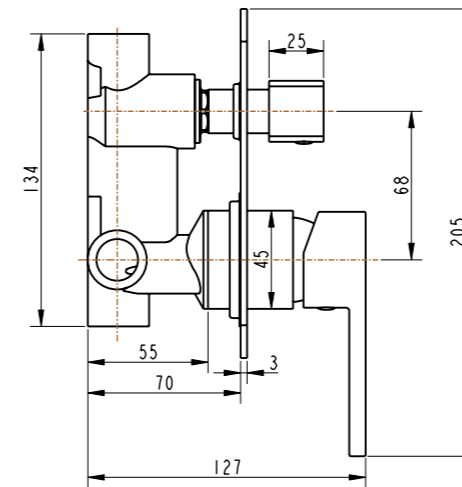
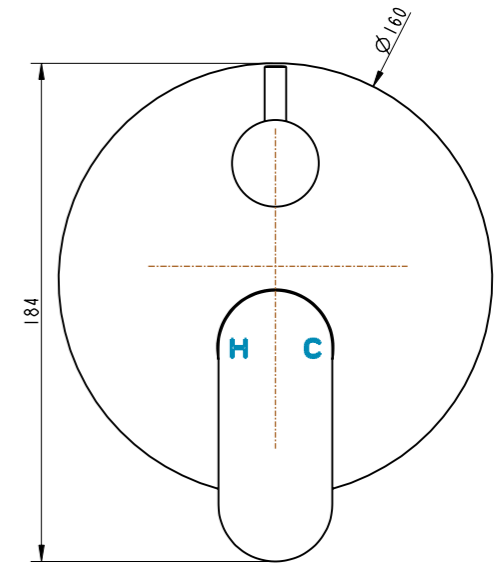
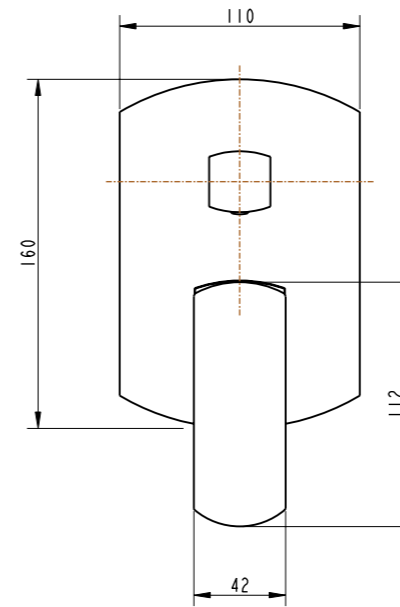

| CODICE <small>Code - Artikel - Article</small> | Descrizione <small>Description - Beschreibung - Description</small> | Prezzo (€) <small>Price - Preis - Prix</small> |
|---|--|---|
| LSMQ 01 | Miscelatore Quadrato - Square mixer - Viereckige Brausebatterie - Mitigeur carré | 182,00 |
| LSMQ 01XB | Miscelatore Quadrato - Square mixer - Viereckige Brausebatterie - Mitigeur carré | 255,00 |
| LSMQ 01B | Miscelatore Quadrato - Square mixer - Viereckige Brausebatterie - Mitigeur carré | 215,00 |
| LSMT 01 | Miscelatore Tondo - Round mixer - Runde Brausebatterie - Mitigeur rond | 169,00 |
| LSMT 01B | Miscelatore Tondo - Round mixer - Runde Brausebatterie - Mitigeur rond | 194,00 |

PROFILI CROMO E NERI UTILIZZABILI CON TUTTE LE SERIE PRESENTI NEL CATALOGO GENERALE.

Chrome and black wall profiles usable with all series present in our general catalogue.
Chrom und Schwarz Wandprofile verwendbar mit allen Serien im Gesamtkatalog.
Profils chromés et noir utilisables pour toutes les séries du catalogue général.

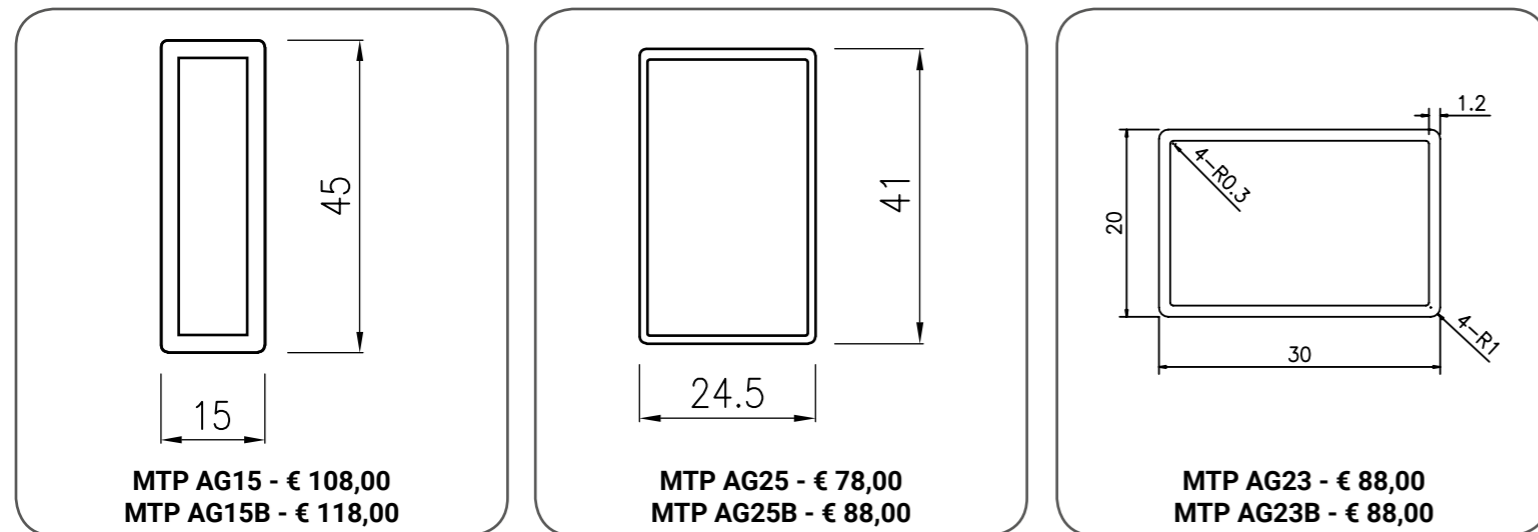

Profili di allungamento in aggiunta. - Additional wall profile adjustment. - Zusätzlicher Verlängerungsprofil. - Profils pour allongement supplémentaire.



GARANZIA
10 ANNI
10 years' Guarantee.
10 Jahre Garantie.
Garantie 10 ans.

*Vedere pag. 518-519 paragrafo N.
*See page 518-519 paragraph N.
*Siehe Seite 518-519 Absatz N.
*Voir page 518-519.

DOSE MONOUSO
Dose disponible
Einzeldosis
Unique



-MADE IN ITALY-

*Le immagini hanno puro scopo illustrativo. - *Fotos nur zum Illustrationszweck -
*Pictures for illustrative purposes only. - *Photos seulement à titre indicatif.

| CODICE Code - Artikel - Article | Dose Dose - Dosis - Dose | Prezzo (€) Price - Preis - Prix |
|------------------------------------|-----------------------------|------------------------------------|
| LKA 100 | 100 ml | 133,00 |



Prodotto idrorepellente per superfici vetrate e cabine doccia.
Water repellent for crystal surfaces and shower enclosures.
Wasserabweisendes Material für Glasoberflächen und Duschkabinen.
Hydrofuge pour les surfaces en verre et cabines de douche.

Bottiglia con erogatore trigger - 1 guanto - Microfibra - Istruzioni bilingue con scheda a colori.
Bottle with dispenser - No.1 glove - Microfiber cloth - Bilingual Instruction Manual.
Nr.1 Flasche mit Spender - Nr.1 Handschuh - Nr.1 Mikrofaser Tuch - Nr.1 Zweisprachige Gebrauchsanweisung.
Flacon avec pistolet - No.1 gant - Chiffon - Mode d'emploi bilingue.

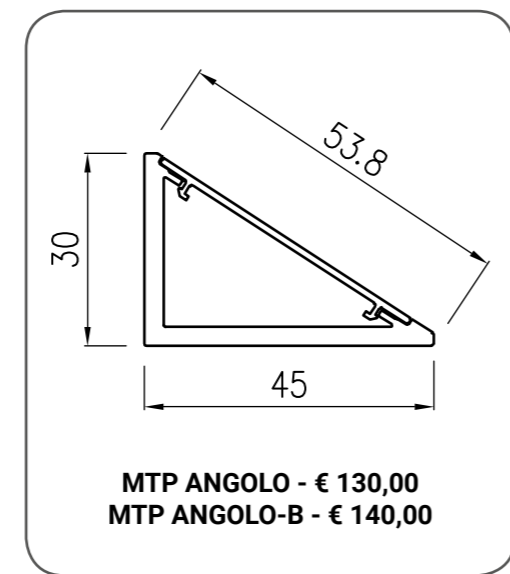
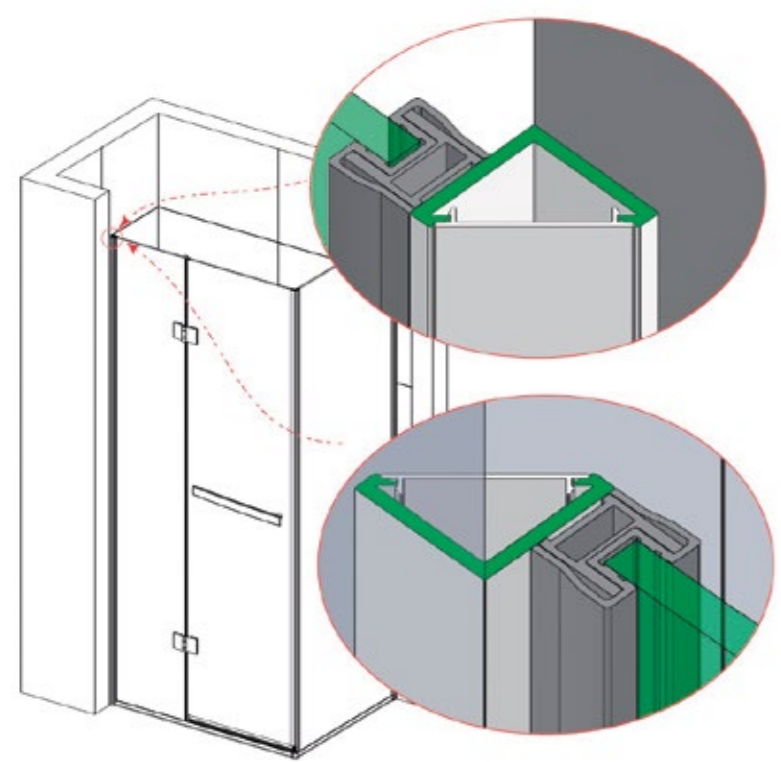

Profilo angolare per fissaggio laterale.
Corner profile for lateral fixing.
Winkelprofil zur seitlichen Befestigung.
Profilé angulaire pour fixation latérale.

TERGICRISTALLI



LTV 03

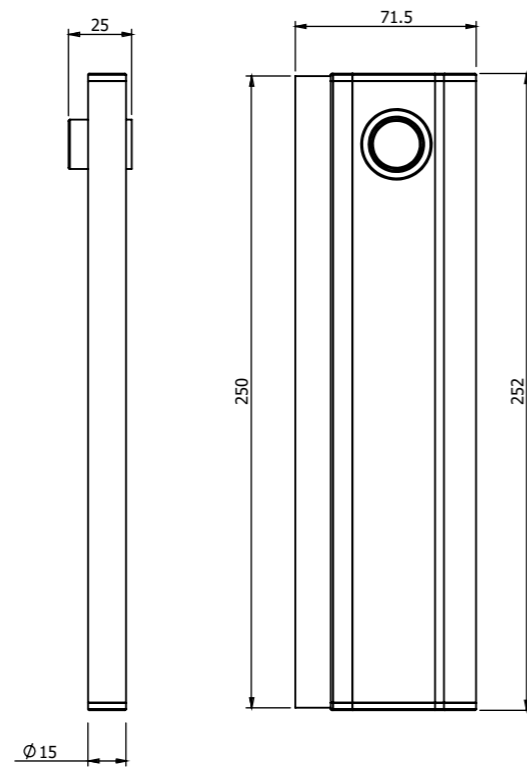

Codice - Code - Artikel - Article Prezzo (€) - Price - Preis - Prix

LTV 02 74,00

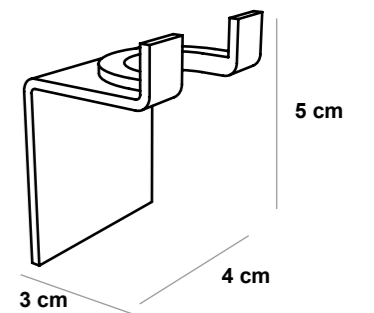
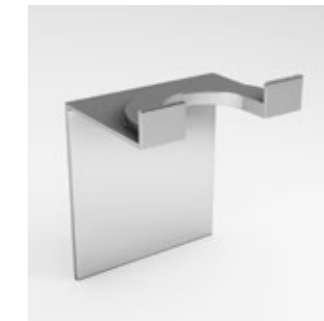
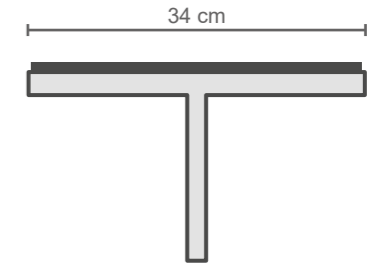

Realizzato in acciaio Inox 304
Made of stainless steel 304 - Aus Rostfreiem Stahl 304 - Fabriqué en acier inoxydable 304
Superficie cromata - Chrome surface - Verchromte Oberfläche - Surface chromée
Attacco a parete adesivo - Adhesive wall fixture - Klebende Wandhalter - Montage mural adhésif

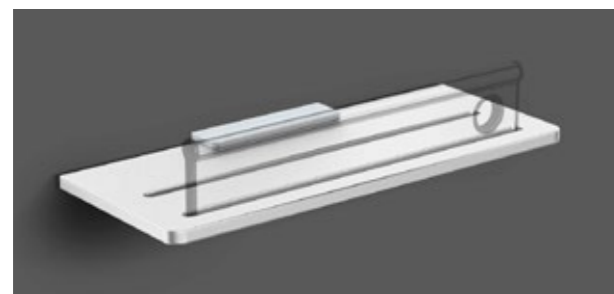

LMR 01

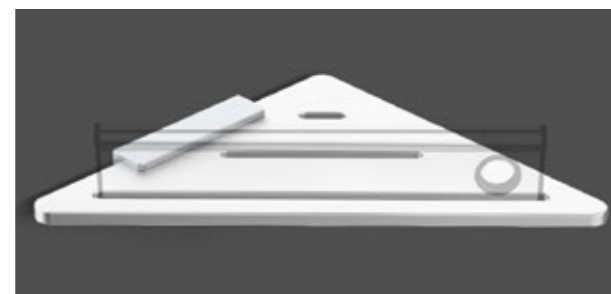

LMT 01

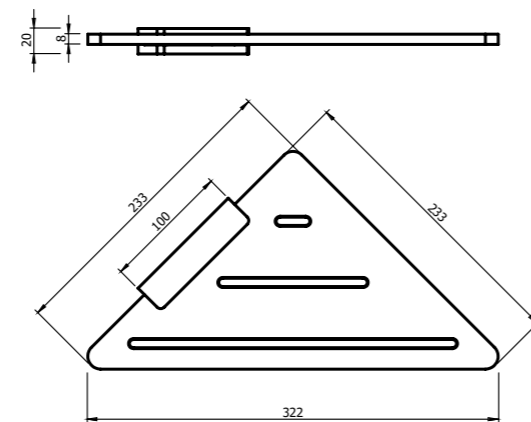
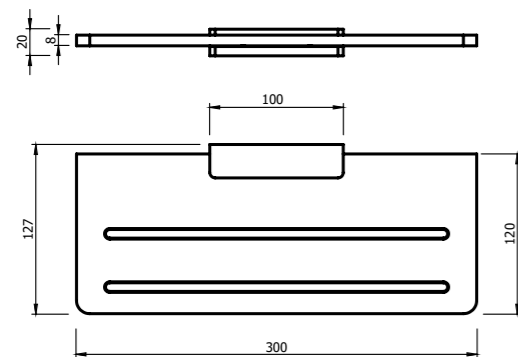

| CODICE - Code - Artikel - Article | Prezzo (€) - Price - Preis - Prix |
|-----------------------------------|-----------------------------------|
| LMR 01 | 112,00 |
| LMT 01 | 125,00 |
| LTV 03 | 70,00 |

Realizzato in alluminio (LTV03) e in acrilico (LMR01 - LMT01) - Made of aluminium and acrylic
Herstellt aus Aluminium und Acryl - Fabriqué en aluminium et acrylique
Superficie anodizzata - Anodised surface - Eloxierte Oberfläche - Surface Anodisée
Colore bianco - White - Weiß - Blanc (LMR01 - LMT01)



Codice - Code - Artikel - Article Prezzo (€) - Price - Preis - Prix

LTV 01 62,00

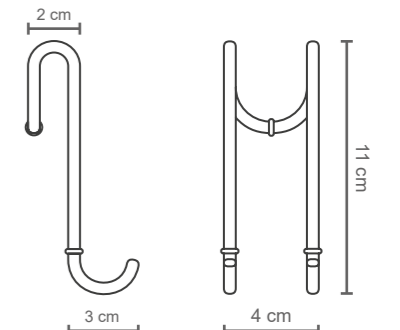
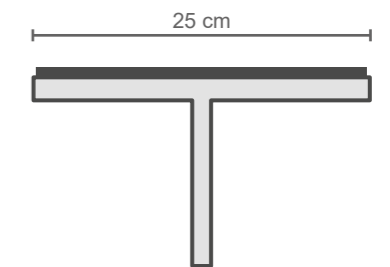

Realizzato in acciaio Inox 304
Made of stainless steel 304 - Aus Rostfreiem Stahl 304 - Fabriqué en acier inoxydable 304
Superficie cromata - Chrome surface - verchromte Oberfläche - Surface chromée

SEDILI E MANIGLIE



MNGD 45 Maniglia diagonale - Diagonal handle
Diagonaler Haltgriff - Barre d'appui coudée

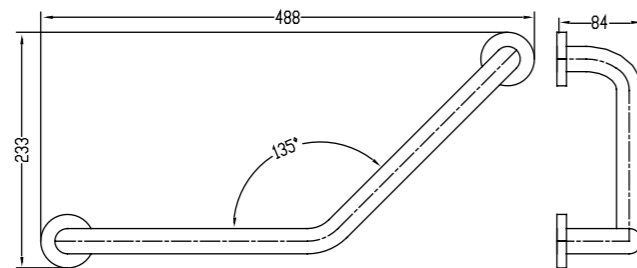

MNGL 45 / 60 Maniglia lineare - Linear handle
Linearer Haltgriff - Barre d'appui

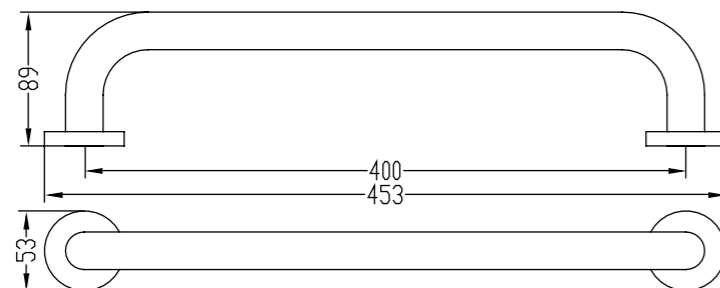

LSDL E 02W Sedile bianco - White seat
Weißer Sitz - Siège blanc

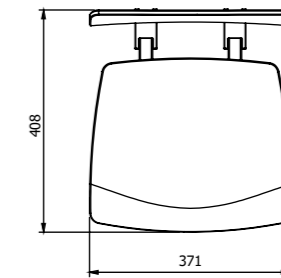
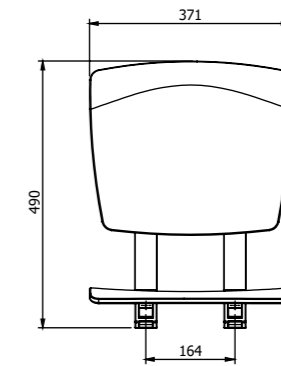

LSDL E 02B Sedile nero - Black seat
Schwarzer Sitz - Siège noir

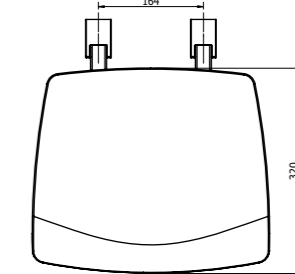
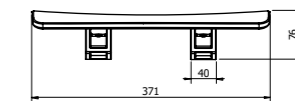

| CODICE Code - Artikel - Article | Formato (cm) Size - Format - Dimension | Prezzo (€) Price - Preis - Prix |
|---|--|---|
| LSDL E 02W | 37 x 7,6 x 39,6 | 415,00 |
| LSDL E 02B | 37 x 7,6 x 39,6 | 415,00 |
| MNGL 45 | 45,3 x 8,9 x 5,3 | 84,00 |
| MNGL 60 | 60,3 x 8,9 x 5,3 | 97,00 |
| MNGD 45 | 49,8 x 23,3 x 8,4 | 107,00 |

Sedile pieghevole (LSDL E02W, LSDL E02B): realizzato in zinco e polipropilene.
Foldable seat (LSDL E02W, LSDL E02B) made of zinc and polypropylene.
(LSDS E02W, LSDL E02B) Klappbarer Sitz aus Zink und Polypropylen.
Siège pliant (LSDL E02W, LSDL E02B) : fabriqué en zinc et polypropylène.

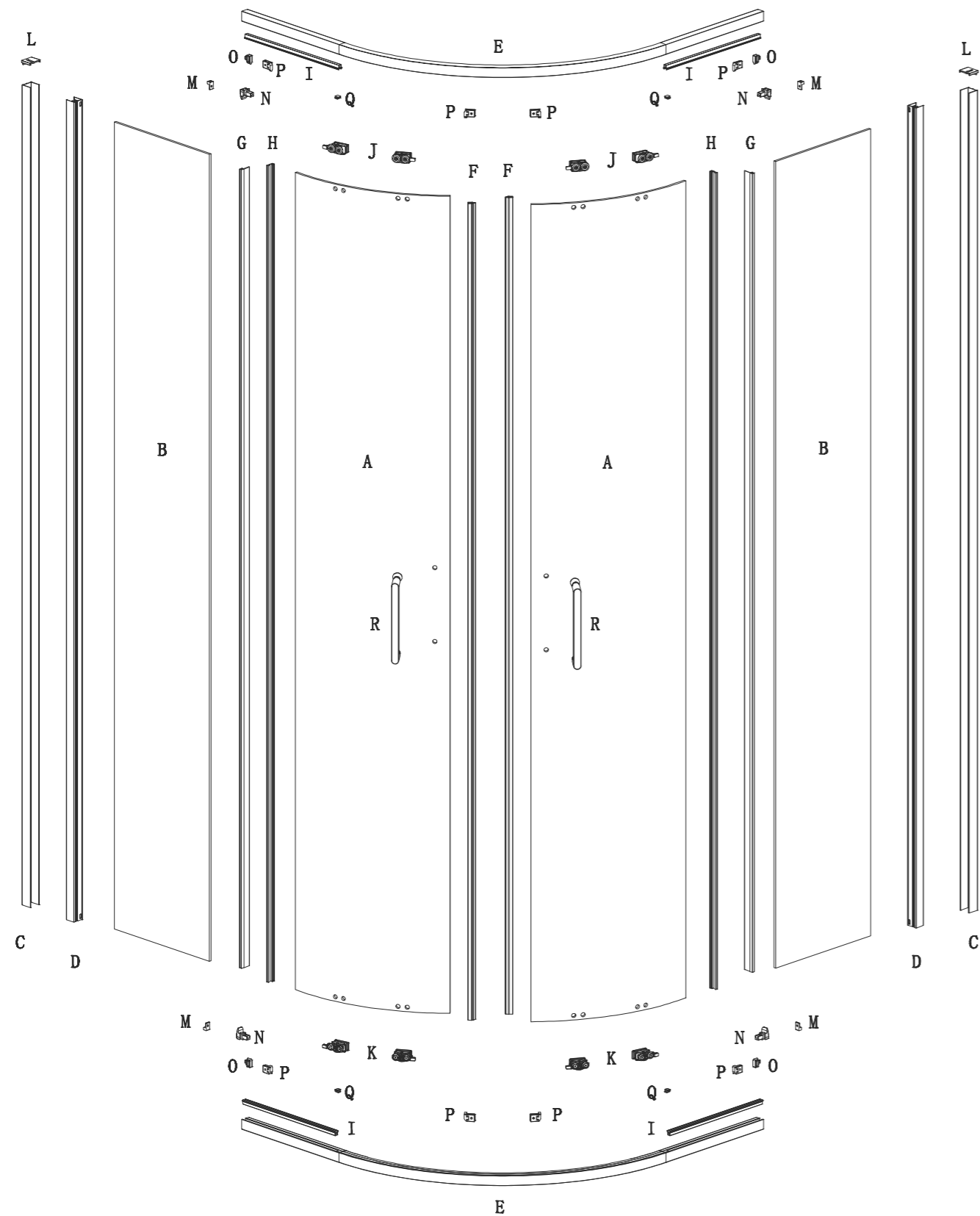

1. Entrare nell'area privata del sito Lacus.
2. Selezionare l'articolo (es. cabine doccia, open space, etc.).
3. Selezionare il modello della cabina (es. lsa, losa etc.).
4. Effettuare il download della scheda tecnica in formato pdf.
5. Comparira' un esploso con i singoli componenti.
6. Stampare ed evidenziare il pz. richiesto indicando sempre il codice completo dell'articolo.
7. Inviare la scansione via mail o fax (indicati sul retro della copertina del catalogo).
8. In caso di difficoltà contattare l'ufficio tecnico Lacus.
9. Per cellulari Smartphone scansionare il QR code presente in ogni serie del catalogo

1. Connect to www.lacus.it and enter into your reserved area.
2. Chose the item by category (i.e Enclosure, Open Space, and so on).
3. Chose the item by series (i.e. Series LSA, LOSA and so on).
4. Download the technical file in PDF.
5. A technical drawing with the single components will appear.
6. Print the drawing and clearly mark the demanded part, providing the right code.
7. Scan the drawing and send it back to Lacus.
8. For any problem please get in touch with our Customer Service.
9. For Smartphone phones scan the QR codes on the relavant catalog pages.

1. Verbinden Sie zu der Webseite www.lacus.it und gehen Sie zum reservierten Bereich der Site.
2. Klicken Sie auf die Elementkategorie (z.B Duschkabine, Open Space, u.s.w.)
3. Klicken Sie auf den Serien-Namen (z.B. LSA, LOSA, u.s.w.).
4. Laden Sie die technischen Unterlagen in PDF-Format herunter.
5. Sie werden eine Zeichnung mit allen Ersatzteilen bekommen.
6. Drücken Sie bitte die Zeichnung und markieren Sie erforderlich den Teil. Bitte geben Sie unbedingt seinen Code bekannt.
7. Senden Sie die markierten Zeichnung an Lacus per E-Mail oder Fax zurück. (Daten finden Sie auf dem hinteren Katalogs-Deckel).
8. Bei Bedarf steht Ihnen unser Kundendienst zur Verfügung.
9. Für Smartphone Telephone QR-Codes auf den entsprechenden Katalogseiten scannen.

1. Connectez-vous à la page web www.lacus.it, saisissez votre adresse email et votre mot de passe.
2. Sélectionnez l'article (par exemple «Cabine de douche» ou «Open Space» etc.).
3. Sélectionnez le modèle désiré (par exemple LSA, Losa etc).
4. Téléchargez le dessin technique en PDF.
5. Le plan des composants va apparaître.
6. Imprimez-le et soulignez la pièce détachée nécessaire avec son code identifiant.
7. Envoyez-nous le schéma par e-mail ou par fax (coordonnées indiquées à l'arrière du catalogue).
8. En cas de difficulté, contactez notre service après-vente.
9. Pour les téléphones Smartphones scannez les Codes des pages correspondantes du catalogue.

“L'invio delle parti di ricambio prevede l'addebito delle spese di trasporto.”

*Transportation cost will be charged when spare parts are shipped.
Mit der Lieferung von Ersatzteilen werden Versandkosten berechnet.
Pour l'envoi de pièces détachées, des frais de transport vous seront facturés.*

SUGGERIMENTI DI INSTALLAZIONE

1. Per una corretta installazione della cabina doccia.

- 1. For proper installation of the shower enclosure.
- 1. Für die ordnungsgemäße Installation der Duschkabine.
- 1. Pour une installation correcte de la cabine de douche.

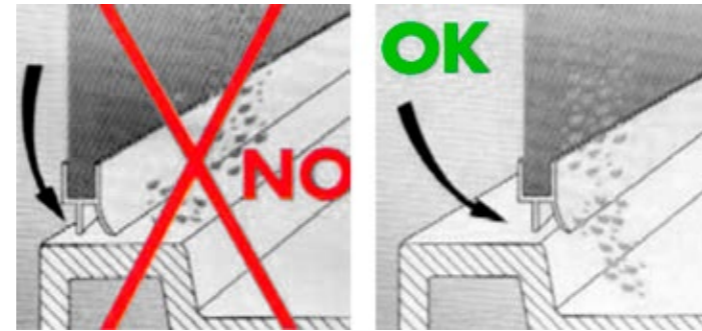

2. Maniglie, pomoli, braccetti e carrucole devono essere avvitati a mano.

- 2. Handles, knobs, arms and pulleys must be tightened by hand.
- 2. Drehknöpfe, Arme und Rollen müssen mit Hand angezogen werden.
- 2. Vissez à la main les poignées, les boutons, les bras et les roulettes.



3. Seguire scrupolosamente le istruzioni di montaggio poste all'interno della scatola o visionabili da QR code posto all'esterno della scatola.

- 3. Follow the installation instructions carefully inside each package or through the QR code outside the package
- 3. Befolgen Sie die Montageanweisungen im Kartons oder vom QR-Code außerhalb des Kartons ersichtlich.
- 3. Suivez attentivement les instructions sur l'installation à l'intérieur de chaque carton ou directement sur le code QR placé à l'extérieur.

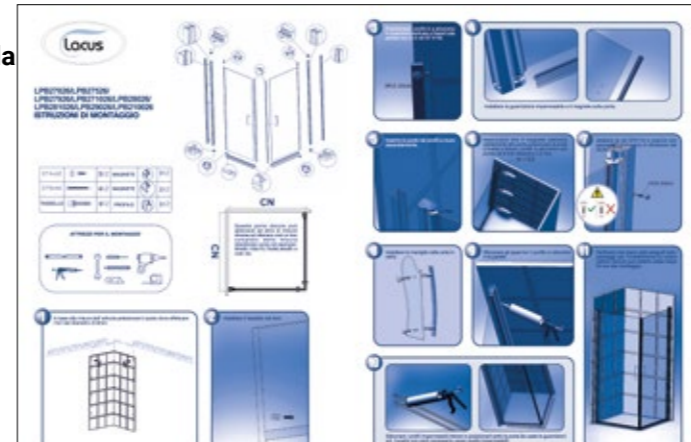

4. Eseguire il pre-montaggio per verificare la planarità del piatto doccia ed il fuori squadra dei muri.

- 4. Perform a pre-installation check to verify the flatness of the tray and the out of square of walls.
- 4. Zur Überprüfung der Ebenheit der Duschtasse und des Schräglaufs der Mauer führen Sie Eine Pre-Installation Check.
- 4. Avant l'installation, contrôlez la planéité du receveur et les faux aplombs.



5. Si consiglia di movimentare i colli di peso superiore ai 25 Kg con l'ausilio di 2 persone.

- 5. We recommend to handle packages weighing more than 25 kg in 2 people.
- 5. Es wird empfohlen, Kartons über 25 kg mit 2 Personen zu handhaben.
- 5. Les colis de plus de 25 kg doivent être manipulés par 2 personnes.



6. Verificare preventivamente se il piatto doccia è in "bolla" ed il corretto deflusso dell'acqua dal foro della piletta.

- 6. Check if the shower tray is "on the bubble" and the correct flow of water from the drain hole.
- 6. Überprüfen Sie, ob die Duschtasse "auf der Blase" ist.
- 6. Vérifiez que le receveur est bien d'aplomb.



7. Utilizzare una protezione per la superficie del piatto doccia durante la posa in opera.

- 7. Use a protection for the surface of the shower during the laying.
- 7. Beim Verlegen einen Schutz für die Oberfläche der Duschtasse verwenden.
- 7. Protégez la surface du receveur pendant l'installation.



8. ATTENZIONE il piatto doccia è in resina e può essere soggetto a variazioni di planarità se tenuto in magazzino in posizione scorretta.

- 8. CAUTION the shower tray is made of resin and may be subject to variations of flatness if kept in stock in wrong position.
- 8. WARNUNG Duschtasse ist aus Harz hergestellt und kann Abweichungen der Ebenheit unterliegen, ob auf Lager in der falschen Lage aufbewahrt.
- 8. ATTENTION: Le receveur étant en résine, une mauvaise position lors de l'entreposage peut entraîner des problèmes de planéité.

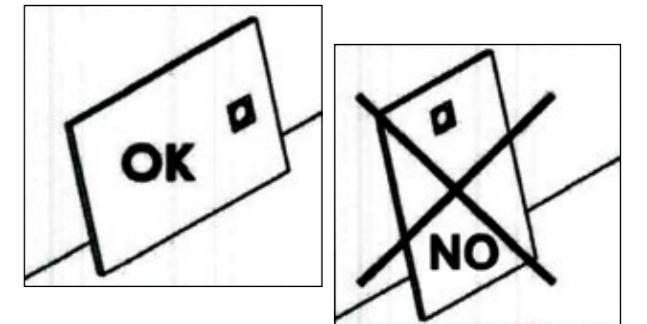

9. Per la posa dei piatti doccia Lacus si consiglia la colla poliuretana.

- 9. For the installation of shower trays Lacus is recommended polyurethane glue.
- 9. Polyurethankleber wird für die Montage der Duschtassen von Lacus empfohlen.
- 9. La colle polyuréthane est recommandée pour l'installation des receveurs Lacus.

10. Colonne doccia: prima di posizionare gli attacchi della colonna doccia prescelta, verificare che la posizione dove verrà collocata, sia compatibile con l'inclinazione del soffione e con la profondità della chiusura doccia.

- 10. Shower columns: Before positioning the connections of the chosen shower column, check that the position in which it will be placed is compatible with the angle of the shower head and the depth of the shower enclosure.
- 10. Duschsäulen: Bevor Sie die Anschlüsse der gewählten Duschsäule positionieren, überprüfen Sie, ob die Position, in der sie platziert wird, mit dem Winkel des Duschkopfs und der Tiefe der Duschkabine kompatibel ist.
- 10. Colonnes de douche: avant de prévoir les raccords de la colonne de douche, s'assurer de l'inclinaison de la douche de tête et de l'ampleur de la cabine de douche.

Chiusure doccia:

1. Mantenere ingrassati i punti di movimento (Carrucole, cerniere).
2. Pulire la superficie cromata con detergenti non acidi o con oggetti che la possono graffiare.
3. Verificare periodicamente che le cerniere, i braccetti e le carrucole siano ben avvitati, utilizzando un cacciavite a mano. (L'avvitatore può causare microfratture nel cristallo che possono provocarne l'esplosione anche ritardata).
4. Detergere i cristalli con l'apposita spatola tergcristalli.
5. Proteggere i cristalli con il Kit LKA 100 di pag. 557.
6. Il trattamento anticalcare è un facilitatore di pulizia non esime l'utilizzatore, dalla necessità di mantenere pulito il cristallo dai residui di calcare.



Shower Enclosures:

1. Keep pulleys and hinges duly oiled.
2. Clean the chrome surface with non-acidic cleaners or other objects which can scratch.
3. Periodically control that the hinges, the arms and the pulleys are tight, using a hand screwdriver. (A drill can cause micro fractures in the crystal that which may crack later).
4. Clean the crystal panels with the wipers.
5. Protect the crystal with LKA 100 kit (page 557).
6. The descaling treatment facilitates cleaning and does not relieve the user from the need to keep the crystal clean from limescale residues.



Duschkabinen:

1. Halten Sie die Rollen und die Scharniere ordnungsmässig geölt.
2. Reinigen Sie die Chromoberfläche mit nicht-sauren Reinigungsmittel oder andere Gegenstände, die zerkratzen können.
3. Überprüfen Sie regelmäßig mit einem Handschraubendreher, dass die Scharniere, die Arme und die Rollen fest sind. (Der Bohrschrauber kann im Kristallglas Mikrofrakturen verursachen, die später das Glas zerbrechen können).
4. Reinigen Sie die Kristallseiten mit den Scheibenwischer.
5. Schützen Sie das Kristallglas mit dem Entkalkungsmittel von Lacus Kit LKA100 (S.557).
6. Die Entkalkungsbehandlung erleichtert die Reinigung und befreit den Benutzer nicht von der Notwendigkeit, das Glas von Kalkrückständen sauber zu halten.

Cabines de douche:

1. Gardez les roulettes et les charnières engrainées.
2. Nettoyez la surface chromée avec des détergents non acides. Evitez tout autre objet pouvant rayer la surface.
3. Vérifiez périodiquement que les charnières, les bras et les roulettes soient bien serrés, en utilisant un tournevis à la main. (La visseuse peut provoquer de minuscules fractures dans le verre pouvant causer sa rupture).
4. Nettoyez et essuyez soigneusement les côtés avec les essuie-glace.
5. Protégez les verres avec le kit anticalcaire LKA100 Lacus à la page 557.
6. Le traitement anticalcaire facilite le nettoyage mais il ne dispense pas l'utilisateur d'enlever les résidus de calcaire des verres.

Piatti doccia:

1. Pulire con detergenti neutri, non acidi, non aggressivi (NO candeggina, NO sgrassatore, etc.) o con oggetti che possono graffiarne la superficie.
2. Periodicamente fare manutenzione e pulizia della piletta.

Steli e Soffioni:

1. Se sono ispezionabili: aprire ogni tre mesi il soffione e detergere la guaina in aceto diluito o in anticalcare diluito.
2. Se non ispezionabili: almeno ogni tre mesi far scorrere all'interno del soffione (dopo averlo opportunamente smontato) aceto diluito o anticalcare diluito.
3. Muovere gli ugelli esterni per togliere il calcare depositato.
4. In caso di acqua molto calcarea praticare più volte al mese la manutenzione suddetta.
5. Pulire la superficie cromata con detergenti non acidi o con oggetti che la possono graffiare.

Shower trays:

1. Clean with detergents, non-acidic, non-aggressive (bleach, etc..) Or objects which can scratch the surface.
2. Periodically perform maintenance and cleaning of the drain.

Accessories and heads:

3. Examenable: open at least once a month the head and clean the sheath in diluted vinegar or descaling.
4. Not examinable: after having properly removed it from the shower pour inside the head at least once a month diluted vinegar or descaling liquid.
5. Move the outer nozzles to remove the limestone deposited.
6. If the water is very hard practice above maintenance several times per month.
7. Clean the chrome surface with non-acidic cleaners. Don't use objects which may scratch.

Duschtassen:

1. 1 Reinigen Sie die Duschtassen mit nicht-sauren und nicht-aggressiven (z.B. Bleichmittel) Reinigungsmitteln oder Objekten die die Oberfläche zerkratzen können.
2. In regelmäßigen Abständen führen sie die Wartung und Reinigung der Ablauf.

Vorbauten und Köpfe:

3. Überprüfbar Köpfe: mindestens Einmal in Monat Kopf aufzumachen und den Mantel durch verdünnten Essig oder Entkalkungsmittel zu reinigen
4. Nicht-überprüfbar Köpfe: nach dem Zerlegen, verdünnter Essig oder verdünntes Entkalkungsmittel durchs Innen laufen zu lassen.
5. Kalkablagerung von Düsen mit den Fingern zu entfernen.
6. Sollte das Wasserhart sein, Die Wartung mehrmals im Monat durchzuführen.
7. Verchromte Oberfläche nur mit nicht-sauren Reinigungsmitteln oder Objekten die die Oberfläche nicht zerkratzen können zu reinigen.

Receveurs:

1. Nettoyez avec des détergents neutres, ni acides, ni agressifs (eau de javel, etc.). Evitez tout autre objet pouvant rayer la surface.
2. Effectuez périodiquement l'entretien et le nettoyage de la bonde.

Les accessoires et les douches de tête:

1. Douches de tête ouvrantes: ouvrez-les au moins une fois tous les trois mois et nettoyez avec du vinaigre dilué ou un produit anticalcaire dilué.
2. Douches de tête non ouvrantes: après avoir démonté la douche de tête, lavez l'intérieur avec du vinaigre dilué ou un produit anticalcaire dilué au moins une fois tous les trois mois.
3. Bougez les buses pour éliminer le calcaire.
4. Effectuez cet entretien plusieurs fois par mois en fonction de la dureté de l'eau.
5. Nettoyez la surface chromée avec des détergents non acides. Evitez tout autre objet pouvant rayer la surface.
6. Mitigeur avec cartouche progressive.
7. Deviateur a trois voies con accento acuto sulla prima e di devia e grave sulla a prima di trois.

SERVIZIO ASSISTENZA

CUSTOMER SERVICE
KUNDENDIENST
SERVICE APRÈS-VENTE

LACUS dispone di una rete di Centri Assistenza con tariffario convenzionale formata da personale specializzato per installazione e manutenzione dei prodotti LACUS. Per conoscere il Centro Assistenza più vicino potete inviare una e-mail ad info@lacus.it, oppure interpellare l'agente di zona.

LACUS has a network of service centers with conventional tariff formed by a specialized staff for the installation and maintenance of Lacus products. Find out the nearest Assistance Centre sending an e-mail to info@lacus.it, referring to the area agent.

LACUS verfügt über ein Netzwerk von Service-Centren von ausgebildetem Personal das auf Installation und Wartung von der Lacus Produkten spezialisiert ist und mit einem bereit vorgelegten Tarif arbeitet. Um das Betreuungszentrum in Ihrer Nähe zu finden, senden Sie bitte ein E-Mail an info@lacus.it oder kontaktieren Sie den für Ihre Gegend zuständigen Vertreter.

LACUS a un réseau d'installateurs qualifiés qui travaillent avec une liste de prix conventionnelle, formé par des spécialistes dans l'installation et l'entretien des produits LACUS. Pour connaître le service après-vente le plus proche de chez vous, contactez-nous en ligne à info@lacus.it, ou renseignez-vous auprès de votre agent.

CONTRIBUTO SPESE CHECK CONTROL:

L'intervento del servizio di assistenza prevede l'addebito di un contributo di spese check control che verterà quantificato prima dell'intervento.

Il suddetto addebito non è soggetto a rimborso.

CALL FEE:

The intervention of the Service Centre involves the payment of a fixed call-fee, the cost of which is to be communicated before intervening.

Please notice that this fee is not to be refunded.

RUFGEBÜHR:

Die Intervention des Kundendienst vorsieht eine Rufgebühr die vor der Intervention gemeldet sein muss. Diese Gebühr ist nicht zu erstatten.

FRAIS D'INTERVENTION:

Le déplacement de l'installateur à votre domicile implique le paiement de frais d'intervention non remboursables. Le montant de ces frais sera communiqué à l'avance.



- Il Servizio Assistenza Lacus può essere richiesto per mezzo dell'apposito modulo:
- The Service Lacus can be obtained by means of the form:
- Der Kundendienst kann nur und einfach über unser Formular angefordert werden.:
- Le Service après-vente Lacus peut être obtenu en remplissant le formulaire ci-joint:

.....

RICHIESTA DI INTERVENTO DEL SERVIZIO ASSISTENZA

Richiediamo l'intervento del Vostro Centro Assistenza per risolvere la seguente problematica:

art. descrizione rif. fatt. nr. del.

descrizione del problema.....

.....

.....

.....

EVENTUALI FOTO ALLEGATE SI GIÀ INVIATE NO

FIRMA DEL RICHIEDENTE

.....

DICHIARO DI AVER PRESO VISIONE E DI ACCETTARE LE CONDIZIONI FISSATE NELLE MODALITÀ DI ACCESSO AL SERVIZIO DI ASSISTENZA LACUS, INCLUSO IL PAGAMENTO DEL DIRITTO FISSO DI CHIAMATA DI EURO 50,00 + I.V.A. COME DI LEGGE.

FIRMA DEL RICHIEDENTE

.....

LACUS s.r.l. Via 41049 Sassuolo (MO) - Italy - Tel. +39 0530 822357 - Fax +39 0536 953370
e-mail: info@lacus.it - www.lacus.it - shop: lacus@p.wvl.it - 02356070368

CENTRI DI INSTALLAZIONE LACUS

ASSEMBLY
INSTALLATION
INSTALLATION

AFFIDA L'INSTALLAZIONE AL NOSTRO CENTRO DI ASSISTENZA E MONTAGGIO. CHIEDI SUBITO IL TARIFFARIO AL TUO AGENTE DI ZONA.

ENTRUST OUR SERVICE CENTERS WITH THE ASSEMBLY. ASK FOR THE PRICE-LIST TO OUR AGENT IN YOUR AREA.

VERTRAUEN SIE DIE INSTALLATION AN UNSER SERVICE CENTER. BITTE, STELLEN SIE SICH MIT UNSEREM VERTRETER WEGEN DER PREISLISTE IN VERFÜGUNG.

CONFIEZ VOS TRAVAUX À NOTRE INSTALLATEUR QUALIFIÉ. RENSEIGNEZ-VOUS SUR LES PRIX AUPRÈS DE L'AGENT DE VOTRE SECTEUR.



+1 ANNO DI GARANZIA

AFFIDA L'INSTALLAZIONE AD UN CENTRO DI MONTAGGIO LACUS, USUFRUIRAI DI:

1. Personale qualificato e adeguatamente formato all'installazione di tutti i nostri modelli.
2. Costi di installazione certi e predefiniti.
(Contatta il nostro Agente di zona per visionare il tariffario della Tua città).
3. Un anno di Garanzia in aggiunta (3 anni anziché 2).
4. Nessun contributo spese in caso di malfunzionamento.

+1 YEAR GUARANTEE

ENTRUST OUR SERVICE CENTERS WITH THE ASSEMBLY. YOU WILL ENJOY:

1. Assembly by qualified and trained personnel.
2. Fixed and sure Assembly costs (Please get in touch with our agent in your area to get the price-list).
3. 1 further year warranty (3 instead of 2 years).
4. No call-fee in case of operating faults.

+1 JAHRE GARANTIE

VERTRAUEN SIE DIE INSTALLATION AN UNSER SERVICE CENTER. SIE WERDEN FOLGENDES GENIESSEN:

1. Montage durch qualifizierte und gut-ausgebildete Fachleute.
2. Fix- und versicherte Montage-Kosten (Bitte, melden Sie sich bei unseren Vertretern in Ihrem Gebiet um die Preis-Liste zu bekommen).
3. Ein weiteres Jahr Garantie (3 anstatt 2 Jahre Garantie).
4. Keine Interventionsgebühren wegen Betriebsfehler.

+1 AN DE GARANTIE

CONFIEZ L'INSTALLATION À UN CENTRE D'ASSISTANCE LACUS. VOUS BÉNÉFICIEZ DE:

1. Installation par des spécialistes de tous les produits Lacus.
2. Frais d'installation fixés à l'avance.
(Renseignez-vous auprès de votre agent pour connaître les tarifs dans votre secteur).
3. Un an de garantie supplémentaire (3 ans au lieu de 2).
4. Pas de frais d'intervention en cas de défaut de fonctionnement.

IN CASO DI CONTESTAZIONE

PROCEDURA OPERATIVA IN CASO DI CONTESTAZIONE:

- 1) Segnalare il problema/difetto direttamente al responsabile tecnico aziendale o al rappresentante di zona, compilando l'apposito modulo di segnalazione di contestazione.
- 2) Provvedere **SEMPRE** a fornire i dati relativi alla consegna dell'articolo oggetto della contestazione: codice modello, data fornitura, rif. fattura o ddt, tipologia del difetto.
- 3) Allegare **SEMPRE** alla documentazione alcune fotografie che evidenzino la tipologia del difetto. Se si tratta di cabine doccia fornire sempre una fotografia del cristallo ove è posizionata la scitta Lacus, in quanto è riportata la data di produzione della cabina doccia.

La segnalazione deve essere fatta tempestivamente ed esplicitamente sulla bolla di consegna per difetti evidenti e/o imputabili al trasporto (ad esempio rotture di cristalli), ed entro il termine di 8 giorni dalla consegna in caso di vizi/danni occulti che non siano visibili dall'imballo esterno.

Conservare la scatola fino al completamento dell'installazione ed al collaudo del prodotto.

NON SI ACCETTANO RESI DI PRODOTTI PRIVI DI IMBALLO O CON L'IMBALLO COMPROMESSO.

IN CASE EVENT OF DISPUTE:

1 - Communicate the default directly to our Customer service or to your local agent by means of the appropriate notification form.

2 - Provide detailed information concerning the delivery of the defective model: Reference, delivery date, delivery note and invoice numbers, description of the problem.

3 - Attach photos which show the type of problem. If the problem affects the shower enclosure attach please also pictures of the crystal where the LACUS certification mark is, to help us understand the production date.

In case of visible defects and / or transportation problems (i.e. crystal breakage) the report must be written immediately and clearly on the delivery note. In case of hidden defects - not visible from the outside packaging - communication must be made within 8 days.

Packaging must be kept until the end of the installation and test.

RETURNS WITHOUT OR WITH DAMAGED PACKAGING WILL NOT BE ACCEPTED.

IM STREITFALL:

1- Geben Sie die Mitteilung direkt an Kundendienst oder Ihren lokalen Agenten durch die entsprechende Meldeformular bekannt.

2- Geben Sie detaillierte Informationen über die Ablieferung der mangelhaften Modell bekannt: Artikel, Lieferdatum, Lieferschein- und Rechnungsnummer, Beschreibung des Defekts

3- Liegen Sie Fotos bei, die die Art des Fehlers anzeigen. Wenn es sich um Duschkabine handelt, senden Sie bitte auch Bilder des Glasteils worauf die Lacus -Zertifizierungsmarke liegt, um Herstellungsdatum zu verstehen.

Bei offensichtlichen Defekten und / oder Transportproblemen (z.B. Glasbruch) muss die Angabe sofort und übersichtlich auf dem Lieferschein geschrieben werden. Im Fall von versteckten Mängel die nicht von der Außenverpackung sichtbar sind, muss die Mitteilung innerhalb von 8 Tagen angegeben werden.

Verpackungen müssen bis Ende der Installation und des Test gehalten werden.

RETOUREN OHNE ODER MIT BESCHÄDIGTER VERPACKUNG WERDEN NICHT AKZEPTIERT.

EN CAS DE LITIGE:

1) Communiquez le problème ou le défaut directement au service après-vente ou à l'agent de votre zone en utilisant le formulaire ci-dessous.

2) Fournissez des informations détaillées concernant la livraison du modèle défectueux: référence, date de livraison, bon de livraison et facture, type de défaut.

3) Envoyez des photos qui montrent le type de défaut. Pour les cabines de douche, envoyez aussi des photos du verre avec la certification Lacus qui confirme la date de production.

En cas de défauts évidents et/ou de problèmes de transport (par exemple la rupture du verre), écrivez-le clairement sur le bon de livraison. En cas de défauts ou de vices cachés, la communication doit être faite dans les 8 jours suivant la livraison. Conservez l'emballage jusqu'à l'installation et au test du produit.

LES RETOURS DE PRODUITS SANS EMBALLAGE OU AVEC DES EMBALLAGES ENDOMMAGÉS NE SERONT PAS ACCEPTÉS.

LACUS SRL

- Modulo di segnalazione di contestazione.
- Reporting form of dispute.
- Berichterstattung Form des Streitiges.
- Formulaire de litige.

The complaint reporting form for foreign markets can be downloaded online or directly in the Company via email info@lacus.it.

Das Beschwerdemeldformular Meldeformular für ausländische Märkte kann online oder direkt bei Lacus per E-Mail info@lacus.it heruntergeladen werden.

Le formulaire de litige pour les marchés étrangers peut être téléchargé en ligne ou demandé directement à Lacus par courriel à l'adresse : info@lacus.it.

LACUS SRL : MODULO DI SEGNALAZIONE DI CONTESTAZIONE

Data NR. CONTESTAZIONE..... AGENTE

CLIENTE

Codice articolo.....

Data della fornitura Nr. Fattura o DDT

Quantità del materiale fornito.....

Quantità del materiale contestato

A) Box doccia tipologia del difetto (apporre una croce nelle apposite caselle)

1) Difetti sul cristallo o segni
o macchie.....
o altro.....

2) difetti sul profilo o segni

3) difetti delle guarnizioni o perdita d'acqua
o magneti difettoso.....

4) Carrucole o difettose.....

5) altri tipi di difetto

B) Soffioni e/o Piatti Doccia (apporre una croce nelle apposite caselle)

Rotture varie o

Difetti fisici o segni o graffi
o macchie
o altro.....

Difetti di funzionamento

D) Documentazione allegata

Effettuate N. fotografie

Visionato il da

E) FASE DI AVANZAMENTO

F) Chiusura Contestazione

CONDIZIONI GENERALI DI VENDITA

- A. I prezzi del presente listino, espressi in Euro, s'intendono per merce franco nostro magazzino di Sassuolo, IVA esclusa.
- B. Gli ordini, validi solo se trasmessi per iscritto, ed evadibili anche parzialmente, si intendono confermati ed accettati ai prezzi ed alle condizioni in vigore il giorno di ricezione. In caso contrario l'ordine sarà definitivo solo alla ricezione della nostra conferma d'ordine controfirmata per accettazione.
- C. L'eventuale richiesta di annullamento di un ordine non comporta la sua automatica accettazione, infatti la ditta produttrice comunicherà per iscritto al cliente eventuali addebiti derivati dalla richiesta e solo dopo la ricezione della copia controfirmata riterrà nullo l'ordine.
- D. I prezzi indicati nel presente listino includono l'imballo. Nel caso in cui, per garantire l'integrità del materiale durante il trasporto si rendesse necessario l'imballo su pallets, questo verrà fatturato al costo.
- E. Gli ordini pervenuti durante la settimana saranno raggruppati in un unico ordine, salvo esplicita richiesta di pronta evasione.
- F. I tempi di consegna dei prodotti ordinati si ritengono con media di 4/6 settimane. Nel conteggio dei tempi di consegna non sono comprese le settimane di chiusura per ferie aziendali (Agosto) o per Natale. Evasione di prodotti con termini precedenti costituiscono titolo preferenziale.
- G. Nessuna richiesta di risarcimento danni sarà accettata per il mancato rispetto dei tempi di consegna, forniti, dove richiesto, a puro titolo indicativo e non tassativo.
- H. Nel caso di mancato pagamento alla scadenza, secondo condizioni concordate inizialmente e tacitamente rinnovate di volta in volta se non diversamente confermate saranno addebitate le eventuali spese ed interessi bancari nella misura del 2% mensile. Inoltre LACUS si riserva il diritto di sospendere ogni altra consegna, senza necessità di preavviso, fino all'avvenuto pagamento di quanto dovuto.
- I. Premesso che come stabilito dall'art. 1510 del c.c., la merce viaggia sempre a rischio e pericolo del committente, la ditta produttrice informa che non accetterà contestazioni per danni causati dal trasporto ed invita pertanto il destinatario a contestare alla ricezione eventuali anomalie al vettore, indicandola sulla bolla di consegna.
- L. LACUS, nella costante ricerca del miglioramento della propria gamma, si riserva il diritto di modificare senza preavviso i dati e le caratteristiche dei prodotti contenuti nel presente listino.
- M. Quanto sopra esposto si intende integralmente accettato con la trasmissione dell'ordine. Qualora sorgessero controversie sarà competente il Foro di Modena.
- N. Garanzia trattamento anticallcare LKA 100 - in caso di contenzioso accertato sarà riconosciuto un kit in omaggio. La garanzia decade in caso di non corretta o parziale applicazione.

GENERAL SALES CONDITIONS

- A. Prices are expressed Euro, and are meant ex-works Sassuolo.
- B. Orders are valid only in the written form and are meant confirmed and accepted to the prices and conditions in force during the day of receipt. Otherwise, the order will be considered valid only after receipt of LACUS order confirmation countersigned for acceptance.
- C. Possible request of order cancellation does not automatically imply its acceptance: LACUS will inform the customer in writing about eventual charges. The order will be considered as cancelled only after receipt of countersigned copy.
- D. Prices include packaging. Where loading on pallets is needed, relative costs will be invoiced.
- E. Orders received during the week will be gathered in a single production order, exception made for explicit request of immediate delivery.
- F. Delivery times from the date of order registration: on the average within 4/6 weeks. Summer (August) and Christmas vacations are not included in the calculation of a.m. delivery times.
- G. LACUS will not accept penalties in case of delayed deliveries. Delivery times are indicative and not binding.
- H. H) In case of delayed payment, according to conditions agreed at the moment of order and tacitly renewed from time to time unless otherwise confirmed, eventual bank fees and interests will be charged in the extent of 2% monthly. LACUS reserves the right to stop any further delivery, without notice, until the due amount has been settled.
- I. Goods are always shipped at buyer's own risk and danger, according to art. 1510 of C.C. (civil code). LACUS will not accept claims due to transport damages, so the receiver is invited to check and to object eventual damages to the carrier at the time of delivery, by indicating them on the delivery documents.
- L. LACUS is constantly trying to improve its own production; this means that LACUS reserves the right of changing data and characteristics of its products without notice.
- M. What above described is meant wholly accepted by order transmission. Eventual disputes are to be settled through the Forum of Modena.
- N. Descaling treatment LKA100 guarantee: Once a complaint is established, 1 kit of treatment will be shipped free of charge. Guarantee is considered as lapsed whenever the treatment is partially or incorrectly applied.

ALLGEMEINE VERKAUFSBEDINGUNGEN

- A. Die hier aufgeführten Euro-Preise verstehen sich ab Lager in Sassuolo (MO), exkl. MwSt.
- B. Bestellungen sind nur in schriftlicher Form gültig und auch partiell auslieferbar; die Bestellungen verstehen sich automatisch bestätigt und akzeptiert im Moment des Warenerhalts gültigen Preisen und Konditionen. Andernfalls ist eine Bestellung nur gültig ab Erhalt einer gegengezeichneten Auftragsbestätigung unsererseits.
- C. Das eventuelle Stornieren einer Bestellung ist nicht automatisch als akzeptiert zu verstehen; tatsächlich wird der Hersteller dem Kunden eventuell anfallende Kosten schriftlich mitteilen, und nur infolge Rücksendung dieser vom Kunden gegengezeichneten Mitteilung, ist die Bestellung effektiv storniert.
- D. Die hier aufgeführten Preise beinhalten die Verpackung. Im Falle, dass zur Wahrung der Unversehrtheit des Materials während des Transports eine Verpackung auf Palette notwendig sein sollte, so wird diese zum Anschaffungspreis verrechnet.
- E. Die innerhalb einer Woche eingehenden Bestellungen werden zu einem einzigen Auftrag zusammengefasst, es sei denn, es wird ausdrücklich eine sofortige Auslieferung angefragt.
- F. Die Lieferzeiten der bestellten Artikel belaufen sich im Mittel auf vier bis sechs Wochen. In der Berechnung der Lieferzeiten sind die Betriebsferien im August und zu Weihnachten nicht eingeschlossen. Die Auslieferung von Waren vorhergegangener Bestellungen wird vorrangig behandelt.
- G. Die Firma akzeptiert keinerlei Anforderungen auf Schadenersatz wegen Nichteinhaltung der Lieferzeiten, welche nurauf Anfrage genannt werden und einen reinen Richtwert darstellen, der nicht bindend ist.
- H. Sollte keine fristgerechte Zahlung eingehen, werden gemäß der zu Beginn vereinbarten Bedingungen, welche sich automatisch erneuern, wenn nichts anderes vereinbart wird, eventuelle Mahnkosten sowie Bankzinsen in Höhe von 2% pro Monat berechnet. Weiterhin behält sich LACUS das Recht vor, jegliche weitere Lieferung einzustellen, auch ohne Vorankündigung, und bis zum Eingang der geschuldeten Beträge.
- I. Gemäß Art. 1510 des Codice Civile reist die Ware immer auf Gefahr des Auftraggebers; der Hersteller weist daraufhin, dass er keine Beanstandungen aufgrund von Transportschäden akzeptiert und rät daher dem Empfänger; eventuelle Anzeichen auf Beschädigung der Ware beim Transport sofort dem Transporteur zu melden und auf dem Lieferschein zu vermerken.
- L. Da der Hersteller LACUS kontinuierlich an der Verbesserung seiner Produktpalette arbeitet, behält er sich das Recht vor; auch unan gekündigt die technischen Daten und Eigenschaften der hier aufgeführten Produkte zu ändern.
- M. Die oben aufgeführten Angaben verstehen sich bei Eingang einer Bestellung als in ihrer Gesamtheit akzeptiert. Im Falle einer Rechtsstreitigkeit ist der Gerichtsstand Modena zuständig.
- N. Entkalkungsbehandlung LKA 100 Garantie: Im Streitfall wird 1 Kit frei gesandt. Soll die Behandlung Teil- oder nicht richtig angewandt werden, ist die Garantie annulliert.

CONDITIONS GENERALES DE VENTE

- A. Les prix tarif HT sont en euro départ notre usine de Sassuolo.
- B. Les commandes, envoyées par écrit, sont confirmées aux prix tarif en vigueur le jour de leur envoi. Dans le cas contraire, la commande sera définitive si acceptée par le client.
- C. L'annulation d'une commande doit être confirmée par Lacus.
- D. Les prix tarif prévoient l'emballage. L'emballage sur palette, si nécessaire, sera communiqué et facturé.
- E. Les commandes de la semaine seront regroupées et expédiées ensemble.
- F. Les délais de livraison sont en moyenne de 4/6 semaines. Le mois d'août et la période de Noël sont exclus de cette moyenne.
- G. Lacus ne sera tenue à aucune indemnisation pour le non-respect des délais de livraison qui ne sont qu'indicatifs et non péremptoirs.
- H. En cas de retard de paiement, des pénalités (2% mensuel) seront appliquées et toute livraison sera bloquée jusqu'au règlement total de la dette.
- I. Les marchandises voyagent aux risques et périls du client comme précisé dans l'article 1510 du c.c. Aucune contestation ne sera acceptée en cas de dommages survenus durant le transport. Le client est prié de contrôler la marchandise et de signaler au transporteur tout dommage sur le bordereau de livraison.
- L. Lacus, recherche l'amélioration constante de ses produits et se réserve le droit de modifier, à tout moment et sans avis préalable, les caractéristiques techniques des éléments montrés dans ce catalogue. L'entreprise décline toute responsabilité pour d'éventuelles inexactitudes dans le présent catalogue.
- M. Ce qui précède est accepté lors de la commande. Le Tribunal de Modène sera seul compétent pour tout litige.
- N. Garantie du traitement anticallcaire LKA 100 – pour tout litige confirmé, un kit sera fourni gratuitement. La garantie est nulle si le traitement n'a pas été fait correctement.

CREDITS:

Graphic/ Art Director: Gio Aio Studio

Stylist: Francesco Simoni Studio

Images: Francesco Bonifazi + Andrea Avaltroni + M3Progetti

Dicembre 2021

LACUS srl si riserva la facoltà di modificare, in qualunque momento e senza preavviso, le caratteristiche tecniche degli elementi illustrati nel presente catalogo. Declina ogni responsabilità per eventuali inesattezze contenute nello stesso.

LACUS srl reserves the right to modify the technical characteristics of the elements contained in this catalogue without notice and shall not be liable for any inexactness contained herein.

LACUS srl behält sich das Recht vor, die technischen Eigenschaften der im vorliegenden Katalog abgebildeten Elemente jederzeit und ohne Vorbescheid zu ändern. Man lehnt jede Haftung für eventuelle im Katalog enthaltene Fehler ab.

LACUS srl se réserve le droit de modifier, à tout moment et sans avis préalable, les caractéristiques techniques des éléments montrés dans ce catalogue. L'entreprise décline toute responsabilité pour d'éventuelles inexactitudes dans le présent catalogue.